

Technology Data

Energy transport



Energistyrelsen
Danish Energy Agency

**Technology descriptions
and projections for long-term
energy system planning**

Technology Data - Energy transport

First published 2017 by the Danish Energy Agency and Energinet,

E-mail: teknologikatalog@ens.dk, Internet: <http://www.ens.dk/teknologikatalog>

Production: Danish Energy Agency

Front page design: Filip Gamborg

Front cover photo: 400 kV power transmission lines / Energinet

Version number: 0004

Amendment sheet

Publication date

Publication date for this catalogue “Technology Data for Energy Transport” is December 2017. Hereby the catalogue can be updated continuously as technologies evolve, if the data changes significantly or if errors are found.

The newest version of the catalogue will always be available from the Danish Energy Agency’s web site.

Amendments after publication date

All updates made after the publication date will be listed in the amendment sheet below.

Date	Ref.		Description
Nov 2021	121-123 421-423	now	Removal of chapters on CO2 transport including Introduction to the topic and transfer into the new Technology Catalogue for Carbon Capture, Transport and Storage
Mar 2021	131-133		Addition of chapters on transport of gases and liquids including introduction to the topic
Nov 2020	121-123		Addition of chapters on CO2 transport including Introduction to the topic

Preface

The *Danish Energy Agency* publishes catalogues containing data on technologies for energy transport. This is the first edition of the catalogue. This catalogue includes data on a number of technologies which replace previous chapters published in the catalogue for individual heating and energy transport. The intention is that all energy transport technologies from previous catalogues will be updated and represented in this catalogue. Also the catalogue will continuously be updated as technologies evolve, if data change significantly or if errors are found. All updates will be listed in the amendment sheet on the previous page and in connection with the relevant chapters, and it will always be possible to find the most recently updated version on the Danish Energy Agency's website.

The primary objective of publishing technology catalogues is to establish a uniform, commonly accepted and up-to-date basis for energy planning activities, such as future outlooks, evaluations of security of supply and environmental impacts, climate change evaluations, as well as technical and economic analyses, e.g. on the framework conditions for the development and deployment of certain classes of technologies.

With this scope in mind, it is not the target of the technology data catalogues, to provide an exhaustive collection of specifications on all available incarnations of energy technologies. Only selected, representative, technologies are included, to enable generic comparisons of technologies with similar functions.

Finally, the catalogue is meant for international as well as Danish audiences in an attempt to support and contribute to similar initiatives aimed at forming a public and concerted knowledge base for international analyses and negotiations.

Danish preface

Energistyrelsen udarbejder teknologibeskrivelser for en række teknologier til brug for transport af energi. Dette er den første udgave af dette katalog. Dette nuværende katalog indeholder data for en stor del af teknologibeskrivelserne, som erstatter de tidligere udgivne kapitler i kataloget for individuel opvarmning og energitransport. Det er hensigten, at alle teknologibeskrivelserne fra de tidligere kataloger som omhandler energitransport, skal opdateres og integreres her. Desuden vil kataloget løbende opdateres i takt med at teknologierne udvikler sig, hvis data ændrer sig væsentligt eller hvis der findes fejl. Alle opdateringer vil registreres i rettelsesbladet først i kataloget, og det vil altid være muligt at finde den seneste opdaterede version på Energistyrelsens hjemmeside.

Hovedformålet med teknologikataloget er at sikre et ensartet, alment accepteret og aktuelt grundlag for planlægningsarbejde og vurderinger af forsyningsikkerhed, beredskab, miljø og markedsudvikling hos bl.a. de systemansvarlige selskaber, universiteterne, rådgivere og Energistyrelsen. Dette omfatter for eksempel fremskrivninger, scenarieanalyser og teknisk-økonomiske analyser.

Desuden er teknologikataloget et nyttigt redskab til at vurdere udviklingsmulighederne for energisektorens mange teknologier til brug for tilrettelæggelsen af støtteprogrammer for energiforskning og -udvikling. Tilsvarende afspejler kataloget resultaterne af den energirelaterede forskning og udvikling. Også behovet for planlægning og vurdering af klima-projekter har aktualiseret nødvendigheden af et opdateret databeredskab.

Endeligt kan teknologikataloget anvendes i såvel nordisk som internationalt perspektiv. Det kan derudover bruges som et led i en systematisk international vidensopbygning og -udveksling, ligesom kataloget kan benyttes som dansk udspil til teknologiske forudsætninger for internationale analyser og forhandlinger. Af disse grunde er kataloget udarbejdet på engelsk.

Index

Introduction	7
111 Electricity distribution grid.....	30
112 Natural gas distribution grid	55
113 District heating distribution and transmission grid	74
Introduction to transport of gases and liquids.....	93
131 Transport by pipeline.....	122
132 Transport by road	138
133 Transport by ship	145

Introduction

This catalogue presents data for energy transport technologies. Focus is on the existing main systems in Denmark where energy is transported in a geographically widespread network infrastructure. The following energy transport systems (corresponding to the energy carriers) are treated in the catalogue:

- Natural gas, including upgraded biogas
- District heating
- Electricity

Other energy transport systems such as networks for hydrogen, biogas etc. as well as road and sea transport of liquid and solid fuels are not included. Energy storage installations in the respective systems are treated in a separate catalogue on energy storage. The catalogue does not contain prices for the energy itself.

The main purpose of the catalogue is to provide generalized data for analysis of energy systems, including economic scenario models and high-level energy planning.

These guidelines serve as an introduction to the presentations of the different technologies in the catalogue, and as instructions for the authors of the technology chapters. The general assumptions are described in section 1.1. The following sections (1.2 and 1.3) explain the formats of the technology chapters, how data were obtained, and which assumptions they are based on. Each technology is subsequently described in a separate technology chapter, making up the main part of this catalogue. The technology chapters contain both a description of the technologies and a quantitative part including a table with the most important technology data.

General terminology and definitions

The description of energy transport technologies follows a hierarchic terminology to cover the relevant options and variants. The following diagram summarizes the hierarchy followed in the development of the catalogue and the categorization of technologies.

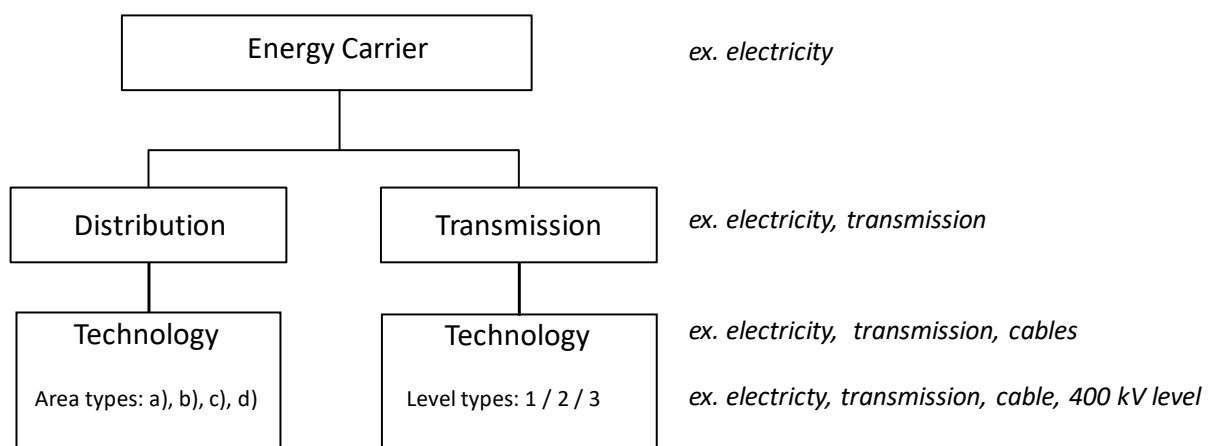

With a view to cross-technology comparisons, a general separation between transmission and distribution systems is maintained throughout the catalogue, as defined below. Thus, an entire energy transport system for a specific energy carrier may consist of a combination of transmission technologies and distribution ones.

Definitions of different components, stations, distribution and transmission systems, as well as some general assumptions follows:

Components:

Single line is defined as a transmission or distribution cable/pipe etc. connecting two points in the network. It has a certain capacity for energy transport, an energy loss, and certain unit costs. For district heating it comprises both the forward and return pipes.

A service line is the connection from the distribution network to each consumer's point of connection. It is assumed to be buried. It usually includes a switch/valve and a metering device at the connection point.

A distribution network is defined as a complete distribution system covering an area, including distribution lines, service lines, and necessary stations.

Two types of stations and substations are considered in this catalogue:

Station Type 1: this category includes all those stations that perform a transformation of the characteristics of the energy carrier (e.g. voltage, pressure, etc.) in correspondence to a change of level or from transmission to distribution.

Examples of these are power transformers or heat exchangers in district heating networks.

Station Type 2: this category includes those stations and equipment needed to provide a certain supply quality or to maintain the characteristics of the energy carrier.

Examples of this type are pumping stations or capacitor banks for reactive power compensation.

Other main components of an energy carrier system can be included as well, where relevant.

Interfaces:

The interfaces for the transport technologies towards other parts of the energy systems are, in general:

Upstream: The energy as delivered from the producer at the connection point. The infrastructure between the plant (power plant, gas processing plant, district heating plant, etc.) and the connection point, including equipment installed at the connection point is included in the plant cost and dealt with in the *Technology Catalogue for Electricity and District Heating Plants*.

Downstream: The energy as delivered to the consumer. Service line and metering equipment at the point of connection are included in transport system costs.

The necessary equipment for transforming and converting the energy carrier's properties on its way through the transport system, (e.g. pressure, voltage, temperature, etc.) and for powering the transport processes (pumps, compressors, etc.) are included, where relevant.

Transmission system, levels and stations:

A transmission system is defined as the network that connects the main energy producers, storage installations, etc. with the distribution networks, so that a transmission network supplies the energy to one or more distribution networks. Usually there are no consumers connected directly to the transmission network, except for very large users or groups of users.

Substations located at points of interface to the distribution networks are included in the transmission system (transformer stations, heat exchangers, etc.). Similarly, substations connecting different levels of transmission belong to the higher level.

For each of the transmission technologies a number of levels are defined corresponding to the relevant voltage, pressure, or temperature levels. Separate data sheets are provided for each transmission level. For some technologies only one level is relevant.

Transmission, [technology]	Level		
	1	2	3
Natural Gas	80 bar	16 – 40 bar	
Electricity, overhead lines	400 kV	132 / 150 kV	50 / 60 kV
Electricity, cables	400 kV	132 / 150 kV	50 / 60 kV
Electricity, HVDC	400 kV		
Electricity, HVDC Sea cables	250-400 kV DC		
Electricity, HVAC Sea cables	400 kV	132 / 150 kV	50 / 60 kV
District heating	< 110 deg. C	<80 deg. C	

Furthermore, a number of different station types may be relevant for a certain technology and level:

Transmission	Stations [type 1] (level change)	Stations [type 2] (auxiliary service)
Natural Gas	- M/R station (pressure release) - Compressor	
Electricity, overhead lines	Transformer station	- Capacitor banks - Reactors
Electricity, cables	Transformer station	- Capacitor banks - Reactors
Electricity, HVDC	Converter station	
District heating	Heat exchanger transmission/distribution	Pumping station

The following figure displays the transmission system specifying its boundaries, different levels, components and stations.

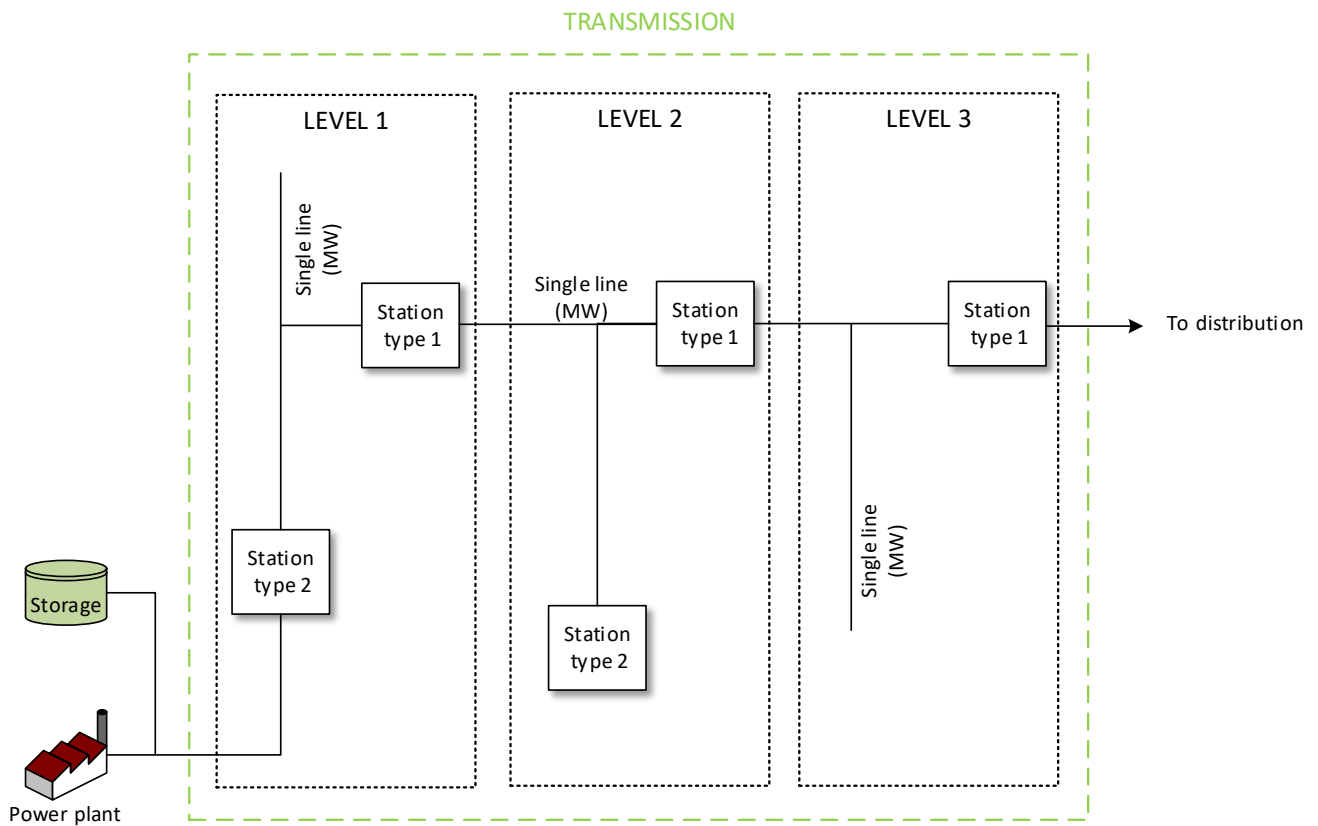

Distribution system, area types and stations:

A distribution system is defined as the network of lines that supplies energy to the consumers in a delimited area. Energy is fed into the system from either transmission networks and/or directly from one or more energy producers. The substations connecting the distribution system to the transmission system are defined to be part of the transmission systems. Other substations internally in the distribution grid are included, including pump stations, regulator stations, transformer stations, valves, etc. The service lines to consumers are also part of the distribution systems.

In this catalogue, energy distribution sub-systems are characterized by their energy consumption density, describing the yearly energy consumption per unit of area (MWh/ha or km²). This density will highly influence the investment cost and, for some energy forms, also the operating costs and losses. In a relatively densely populated area the lengths of lines per unit consumption will be shorter, but on the other hand, the unit installation cost per unit length of distribution line is usually also higher due to more difficult burial work, traffic regulation, etc. For a simplification of this approach four different area types have been defined.

It has to be underlined that this categorization refers to commercial and/or residential areas only, while industrial areas are excluded due to the very diverse nature of consumption depending on the type of industry. Instead, the connection of a specific industry to the distribution grid can be modelled by using single components such as service lines.

The four types of areas defined are the following:

a) **New developed areas**

This reflects a situation where a new area is built and the installation of energy distribution systems is coordinated with the overall construction plan, which lowers the investment costs. The specific energy consumption corresponds to requirements in present and future building codes, i.e. a relatively low energy consumption density for heat, but not necessarily for electric power since heat pumps may be a preferred heating option.

b) **New distribution in existing sparsely populated rural areas, villages, etc.**

In this situation a new energy distribution system is rolled out to an existing area with low energy consumption density.

c) **New distribution in existing medium populated areas, suburban, etc.**

In this situation a new energy distribution system is rolled out to an existing area with medium energy consumption density.

d) **New distribution in existing densely populated areas, city centers, etc.**

In this situation a new energy distribution system is rolled out to an existing area with high energy consumption density.

It is assumed that all relevant consumers are connected.

Separate data sheets are provided for each area type.

For a certain distribution technology, a number of different station types may be relevant:

Distribution	Stations [type 1] (level change)	Stations [type 2] (auxiliary service)
Natural Gas	D/R station	
Electricity, overhead lines	Transformer 10/0.4 kV	
Electricity, cables	Transformer 10/0.4 kV	
District heating	Heat exchanger station	Pump station
District heating, low temperature	Heat exchanger station	Pump station

The following figure displays the distribution system specifying its boundaries, different area types, components and stations.

As indicated, a distribution system can be composed of several distribution networks of different area types, each containing the necessary distribution lines, stations and service lines. Apart from that, the distribution system can also include individual single lines, service lines and stations outside the defined areas.

For this reason, the quantitative description includes data for both the networks defined by area type and the individual components.

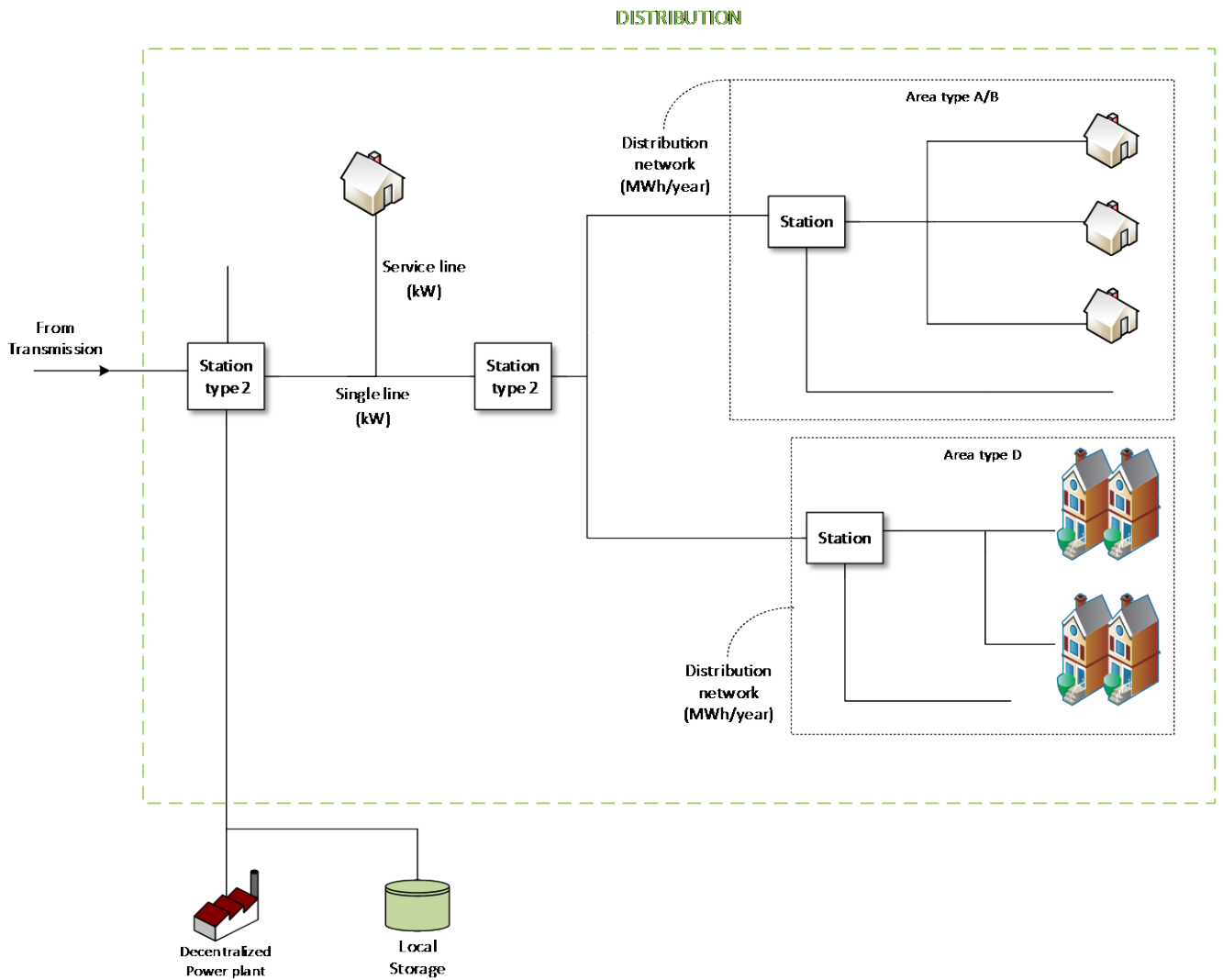

General notes

The unit MW/MWh (or kW and kWh) is used in general for energy and power, though not directly convertible between the energy forms.

For natural gas, a lower calorific value of 39.6 MJ/Nm³ or 0.011 MWh/Nm³ is used for conversion.

Overview of the technologies

Different technologies for transmission and distribution networks are considered and each can be applied to a different transmission level (1, 2, 3) or different distribution area types (a, b, c, d).

An overview of the technologies considered is shown below.

Transmission technologies	Distribution technologies
<ul style="list-style-type: none"> • Natural gas, 80 bar • Natural gas, 40-16 bar • Electricity, overhead lines, 400 kV • Electricity, overhead lines, 132/150 kV • Electricity, overhead lines, 50/60 kV • Electricity, cables, 400 kV • Electricity, cables, 132/150 kV • Electricity, cables, 50/60 kV • Electricity, HVDC, 400 kV • Electricity, HVDC sea cable, 250-400 kV • Electricity, HVAC sea cable, 400 kV • Electricity, HVAC sea cable, 132/150 kV • Electricity, HVAC sea cable, 50/60 kV • District heating, < 110 deg. C / 25 bar • District heating, < 80 deg. C 	<ul style="list-style-type: none"> • Natural gas, area type a) • Natural gas, area type b) • Natural gas, area type c) • Natural gas, area type d) • Electricity, cables, area type a) • Electricity, cables, area type b) • Electricity, cables, area type c) • Electricity, cables, area type d) • District heating, area type a) • District heating low temp., area type a)¹ • District heating, area type b) • District heating, area type c) • District heating, area type d)

Each energy carrier (electricity, gas and district heating) is represented by one qualitative description as explained in Section 1.2. Where relevant, specific information is given for each technology for an energy carrier. Several tables with quantitative data are included for each carrier, representing the different levels and areas. These are based on two different templates: one for transmission and one for distribution. The content of the templates is described in Section 1.3.

1.2. Qualitative description

The qualitative description covers the key characteristics of the technology as concise as possible. The following paragraphs are included where relevant for the technology.

¹ Concerning new developed areas, district heating will consist of two separate data sheets. One for conventional district heating and one for low temperature district heating

Contact information

Containing the following information:

- Contact information: Contact details in case the reader has clarifying questions to the technology chapters. This could be the Danish Energy Agency, Energinet.dk or the author of the technology chapters.
- Author: Entity/person responsible for preparing the technology chapters
- Reviewer: Entity/person responsible for reviewing the technology chapters.

Brief technology description

Brief description for non-engineers of how the technology works and for which purpose.

An illustration of the technology is included, showing the main components and working principles.

Input

The main properties and sources of the energy input in the transport system, and description of the typical interface(s) at input points.

Output

The main properties of the energy at the point of connection to the consumer and the characteristic use of the energy.

Energy balance

The energy balance shows the energy inputs and outputs for the technology. This should also show the energy losses (e.g. heat losses) and the input of auxiliary energy (e.g. electricity for pumping) in the transmission and distribution lines and stations.

Description of transmission system

A description of the transmission systems, including lines, relevant stations for conversion, and auxiliary systems is given here. This includes a description of the relevant technical equipment and various properties of the energy carriers at the different transmission levels, e.g. pressure, temperature, or voltage levels. Thus, the total transmission system may consist of sub-system networks at different transmission levels, with each their properties and characteristics. The main properties and characteristics, including dimensioning criteria and limitations for use are mentioned. The most important installation methods are described, as well as the most important operation and maintenance work.

Description of distribution system

The section contains a description of the distribution system, including a description of the relevant technical equipment and various properties of the energy carriers at the distribution level (e.g. pressure, temperature, and voltage levels), the relevant substation types, and the service line connections to the consumers. In addition, the most important installation methods are described, as well as the most important operation and maintenance work.

Space requirement

Space requirement is specified in 1000 m² per MW per m. The space requirements may for example be used to calculate the rent of land, which is not included in the financial cost, since this cost item depends on the specific location of the installation.

Advantages/disadvantages

A description of specific advantages and disadvantages relative to equivalent technologies. Specific subgroups of technologies can be compared as well (e.g. HVDC vs. HVAC, overhead lines vs. cables, high temperature vs. low temperature DH).

Environment

Particular environmental characteristics are mentioned, for example visual or noise impacts, specific risks in case of leakages and the main ecological footprints.

Research and development perspectives

This section lists the most important challenges to further development of the technology. Also, the potential for technological development in terms of costs and efficiency is mentioned and quantified if possible. Danish research and development perspectives are highlighted, where relevant.

Examples of market standard technology

Recent full-scale commercial projects, which can be considered market standard, are mentioned, preferably with links. A description of what is meant by “market standard” is given in the introduction to the quantitative description section (Section 1.3). For technologies where no market standard has yet been established, reference is made to best available technology in R&D projects.

Prediction of performance and costs

Cost reductions and improvements of performance can be expected for most technologies in the future. This section accounts for the assumptions underlying the cost and performance in 2015 as well as the improvements assumed for the years 2020, 2030 and 2050.

The specific technology is identified and classified in one of four categories of technological maturity, indicating the commercial and technological progress, and the assumptions for the projections are described in detail.

In formulating the section, the following background information is considered:

Data for 2015

In case of technologies where market standards have been established, performance and cost data of recent installed versions of the technology in Denmark or the most similar countries in relation to the specific technology in Northern Europe are used for the 2015 estimates.

If consistent data are not available, or if no suitable market standard has yet emerged for new technologies, the 2015 costs may be estimated using an engineering based approach applying a decomposition of manufacturing and installation costs into raw materials, labor costs, financial costs, etc. International references such as the IEA, NREL etc. are preferred for such estimates.

Assumptions for the period 2020 to 2050

According to the IEA:

“Innovation theory describes technological innovation through two approaches: the technology-push model, in which new technologies evolve and push themselves into the marketplace; and the market-pull model, in which a market opportunity leads to investment in R&D and, eventually, to an innovation” (ref. 6).

The level of “market-pull” is to a high degree dependent on the global climate and energy policies. Hence, in a future with strong climate policies, demand for e.g. renewable energy technologies will be higher, whereby innovation is expected to take place faster than in a situation with less ambitious policies. This is expected to lead to both more efficient technologies, as well as cost reductions due to economy of scale effects. Therefore, for technologies where large cost reductions are expected, it is important to account for assumptions about global future demand.

The IEA’s New Policies Scenario provides the framework for the Danish Energy Agency’s projection of international fuel prices and CO₂-prices, and is also used in the preparation of this catalogue. Thus, the projections of the demand for technologies are defined in accordance with the thinking in the New Policies Scenario, described as follows:

“New Policies Scenario: A scenario in the World Energy Outlook that takes account of broad policy commitments and plans that have been announced by countries, including national pledges to reduce greenhouse gas emissions and plans to phase out fossil energy subsidies, even if the measures to implement these commitments have yet to be identified or announced. This broadly serves as the IEA baseline scenario.” (ref. 7).

Alternative projections may be presented as well relying for example on the IEA’s 450 Scenario (strong climate policies) or the IEA’s Current Policies Scenario (weaker climate policies).

- *Learning curves and technological maturity*

Predicting the future costs of technologies may be done by applying a cost decomposition strategy, as mentioned above, decomposing the costs of the technology into categories such as labor, materials, etc. for which predictions already exist. Alternatively, the development could be predicted using learning curves. Learning curves express the idea that each time a unit of a particular technology is produced, learning accumulates, which leads to cheaper production of the next unit of that technology. The learning rates also take into account benefits from economy of scale and benefits related to using automated production processes at high production volumes.

The potential for improving technologies is linked to the level of technological maturity. The technologies are categorized within one of the following four levels of technological maturity.

Category 1. Technologies that are still in the *research and development phase*. The uncertainty related to price and performance today and in the future is highly significant (e.g. wave energy converters, solid oxide fuel cells).

Category 2. Technologies in the *pioneer phase*. The technology has been proven to work through demonstration facilities or semi-commercial plants. Due to the limited application, the price and performance is still attached with high uncertainty, since development and customization is still needed. The technology still has a significant development potential (e.g. gasification of biomass).

Category 3. Commercial technologies with moderate deployment. The price and performance of the technology today is well known. These technologies are deemed to have a certain development potential and therefore there is a considerable level of uncertainty related to future price and performance (e.g. offshore wind turbines)

Category 4. Commercial technologies, with large deployment. The price and performance of the technology today is well known and normally only incremental improvements would be expected. Therefore, the future price and performance may also be projected with a relatively high level of certainty. (e.g. coal power, gas turbine)

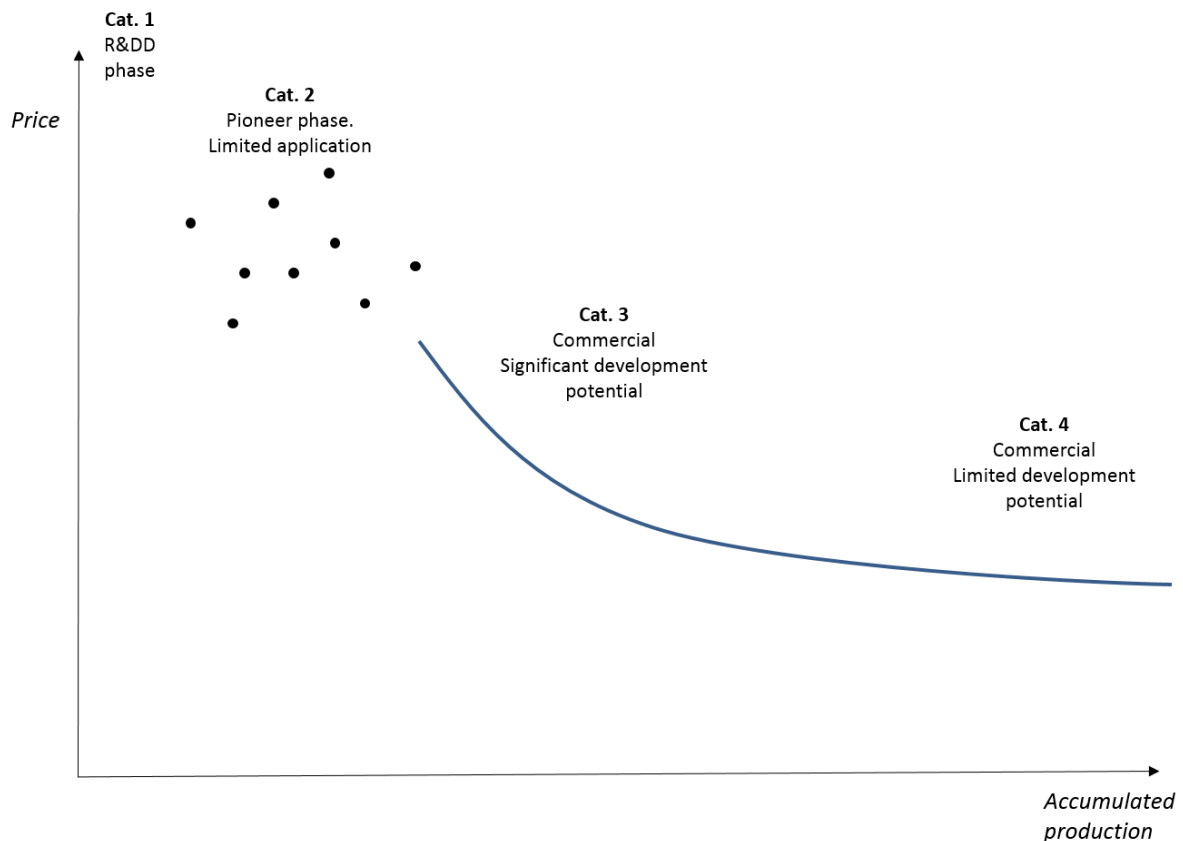

Figure 1: Technological development phases. Correlation between accumulated production volume (MW) and price.

Uncertainty

The catalogue covers both mature technologies and technologies under development. This implies that the price and performance of some technologies may be estimated with a relatively high level of certainty whereas in the case of others, both cost and performance today as well as in the future are associated with high levels of uncertainty.

This section of the technology chapters explains the main challenges to precision of the data and identifies the areas on which the uncertainty ranges in the quantitative description are based. This includes technological or market related issues of the specific technology as well as the level of experience and knowledge in the sector and possible limitations on raw materials. The issues should also relate to the technological development maturity as discussed above.

The level of uncertainty is illustrated by providing a lower and higher bound beside the central estimate, which shall be interpreted as representing probabilities corresponding to a 90% confidence interval. It should be noted, that projecting costs of technologies far into the future is a task associated with very large uncertainties. Thus, depending on the technological maturity expressed and the period considered, the confidence interval may be very large. It is the case, for example, of less developed technologies (category 1 and 2) and longtime horizons (2050).

Additional remarks

This section includes other information, for example links to web sites that describe the technology further or give key figures on it.

References

References are numbered in the text in squared brackets and bibliographical details are listed in this section.

1.3. Quantitative description

To enable comparative analyses between different technologies it is imperative that data are actually comparable: All cost data are stated in fixed 2015 prices excluding value added taxes (VAT) and other taxes. The information given in the tables relate to the development status of the technology at the point of final investment decision (FID) in the given year (2015, 2020, 2030 and 2050). FID is assumed to be taken when financing of a project is secured and all permits are at hand. The year of commissioning will depend on the construction time of the individual technologies.

A typical table of quantitative data is shown below, containing all parameters used to describe the specific technologies. The datasheet consists of a generic part, which is identical for all technologies and a technology specific part, containing information which is only relevant for the specific technology. The generic part is made to allow for easy comparison of technologies. Each cell in the table contains only one number, which is the central estimate for the market standard technology, i.e. no range indications.

Uncertainties related to the figures are stated in the columns named *uncertainty*. To keep the table simple, the level of uncertainty is only specified for years 2020 and 2050.

The level of uncertainty is illustrated by providing a lower and higher bound. These are chosen to reflect the uncertainties of the best projections by the authors. The section on uncertainty in the qualitative description for each technology indicates the main issues influencing the uncertainty related to the specific technology. For technologies in the early stages of technological development or technologies especially prone to variations of cost and performance data, the bounds expressing the confidence interval could result in large intervals. The uncertainty only applies to the market standard technology; in other words, the uncertainty interval does not represent the product range (for example a product with lower efficiency at a lower price or vice versa).

The level of uncertainty is stated for the most critical figures such as investment cost and energy losses. Other figures are considered if relevant. If a certain value in the data sheet has the value zero, this is stated as "0". If the value is not relevant the field is left blank. All data in the tables are referenced by a number in the utmost right column (Ref), referring to source specifics below the table. The following separators are used:

; (semicolon) separation between the four time horizons (2015, 2020, 2030, and 2050)

/ (forward slash) separation between sources with different data

+ (plus) agreement between sources on same data

Notes include additional information on how the data are obtained, as well as assumptions and potential calculations behind the figures presented. Before using the data, please be aware that essential information may be found in the notes below the table.

The datasheets for energy distribution technologies and energy transmission technologies are presented below:

Introduction

General data sheet – Distribution technologies

[one data sheet per area type, if relevant]

Technology	Energy Transport [Technology] Distribution, [area type sub-division]									
	2015	2020	2030	2050	Uncertainty (2020)		Uncertainty (2050)		Note	Ref
Energy/technical data					Lower	Upper	Lower	Upper		
Energy losses, lines (%)										
Energy losses, stations (%)										
Auxiliary electricity consumption (% of energy delivered)										
Technical life time (years)										
Typical load factor (unitless ratio)										
- Residential										
- Commercial										
Construction time (years)										
Financial data										
Investment costs										
Distribution network costs (EUR/MWh/year) [Area type]									A	
Service line costs, 0 - 20 kW (Eur/unit)										
Service line costs, 20 - 50 kW (Eur/unit)										
Service line costs, 50-100 kW (Eur/unit)										

Introduction

Service line costs, above 100 kW (Eur/unit)										
Single line costs, 0-50 kW (EUR/m)										
Single line costs, 50-250 kW (EUR/m)										
Single line costs, 100-250 kW (EUR/m)										
Single line costs, 250 kW - 1 MW (EUR/m)										
Single line costs, 1 MW - 5 MW (EUR/m)										
Single line costs, 5 MW - 25 MW (EUR/m)										
Single line costs, 25 MW - 100 MW (EUR/m)										
Reinforcement costs (Eur/MW)										
[type 1] station (EUR/MW)										
[type 2] station (EUR/MW)										
Investments, percentage installation (%)										
Investments, percentage materials (%)										
Operation and maintenance costs										
Fixed O&M (EUR/MW/year)										
Variable O&M (EUR/MWh)										
Technology specific data										

Notes

Introduction

A: Distribution network costs include the necessary distribution lines, service lines and stations to supply an area.

General Data Sheet – Transmission technologies

[one data sheet per level type, if relevant]

Technology	Energy Transport [Technology] Transmission, [level type]									
	2015	2020	2030	2050	Uncertainty (2020)		Uncertainty (2050)		Note	Ref
Energy/technical data					Lower	Upper	Lower	Upper		
Energy losses, lines 1-20 MW (%)										
Energy losses, lines 20-100 MW (%)										
Energy losses, lines above 100 MW (%)										
Energy losses, stations [Type 1] (%)										
Energy losses, stations [Type 2] (%)										
Auxiliary electricity consumption (% energy transmitted)										
Technical life time (years)										
Typical load factor (unitless ratio)										
Construction time (years)										

Introduction

Financial data										
Investment costs										
Single line costs, 0 - 50 MW (EUR/MW/m)										
Single line costs, 50-100 MW (EUR/MW/m)										
Single line costs, 100 - 250 MW (EUR/MW/m)										
Single line costs, 250-500 MW (EUR/MW/m)										
Single line costs, 500-1000 MW (EUR/MW/m)										
Single line costs, above 1000 MW (EUR/MW/m)										
Reinforcement costs (Eur/MW)										
[type 1] station (EUR/MW)										
[type 2] station (EUR/MW)										
Investments, percentage installation (%)										
Investments, percentage materials (%)										
Operation and maintenance costs										
Fixed O&M (EUR/MW/km/year)										
Variable O&M (EUR/MWh/km)										
Technology specific data										

Notes

Energy/technical data

Each transmission technology data sheet includes the technology name and the level type in the header.

Each distribution technology data sheet includes the technology name and the area type in the header.

Energy losses

The losses in energy transport systems are given in percent of the energy delivered to the system, as an average over a normal (or average) year for the relevant area type (e.g. an energy loss of 50% means that half the energy fed into the system during a normal year is lost). These general values are based on experience and express typical values for representative new distribution and transmission systems. The uncertainty values indicate estimated variances from average systems, with a confidence interval of 90%.

For distribution systems, the losses are divided into line losses and single station losses. The former represents an average for the total length of network lines including service lines. Line losses for the distribution side are given as average system values for the respective area types.

The latter, expresses the typical losses in stations, if any.

For transmission systems, line losses are given as typical average system values in percent of the energy flow for three different capacity ranges:

- Small lines, 1-20 MW
- Medium lines, 20 - 100 MW
- Large lines, above 100 MW

Energy losses in stations consist of the typical losses, if any, in various types of stations, e.g. transformer stations. They distinguish between losses in station types 1 and 2.

Furthermore, for district heating and gas systems in particular, there may be auxiliary energy consumption necessary for the operation of the system (pumps and compressors, heating of gas after decompression, etc.).

In case of transmission, the auxiliary consumption is stated as the typical energy use for transmitting each unit of energy in the system (% of energy transmitted).

In distribution systems, typical auxiliary energy consumption necessary for the operation of the system (pumps and compressors, heating of gas after decompression, etc.) is given as average values for the area (% of energy delivered).

Technical lifetime

The technical lifetime is the expected time for which an energy line or pipe can be operated within, or acceptably close to, its original performance specifications, provided that normal operation and maintenance takes place. During this lifetime, some performance parameters may degrade gradually but still stay within acceptable limits. For instance, energy losses often increase slightly over the years, and O&M costs increase due to wear and degradation of components and systems. At the end of the

technical lifetime, the frequency of unforeseen operational problems and risk of breakdowns is expected to lead to unacceptably low availability and/or high O&M costs. At this time, the line/pipe is decommissioned or undergoes a lifetime extension, which implies a major renovation of components and systems as required to make it suitable for a new period of continued operation.

The technical lifetime stated in this catalogue is a theoretical value inherent to each technology, based on experience.

In real life, specific installations of similar technology may operate for shorter or longer times. The strategy for operation and maintenance, e.g. the number of operation hours and the reinvestments made over the years, will largely influence the actual lifetime.

Typical load factor

The typical load factor expresses the utilization rate of the system.

It is expressed with a value between 0 and 1, where zero means no utilization of the system and 1 corresponds to full utilization.

In a typical transmission or distribution network, the total rated load is rarely or never reached, since the demand is diversified in time and not simultaneous.

Typical load factor is calculated as average load in a year divided by maximum load. Similarly, it could be calculated as energy transported yearly divided by maximum load and 8760 hours.

The following formula applies:

$$\text{Typical load factor} = \frac{\text{Average load [MW]}}{\text{Maximum load [MW]}} = \frac{\text{Energy transported yearly [MWh]}}{8760 [h] * \text{Maximum load [MW]}}$$

For distribution systems different values are given for typical residential and commercial areas.

The data sheet for area 'type a)' presents the load factor for an area where new building standards (BR 10 or later) apply.

For transmission systems the load factor values vary widely, and the expected mean value is stated. The notes may indicate an expected range for lower and higher values.

Construction time

Time from final investment decision (FID) until commissioning completed (start of commercial operation), expressed in years.

Financial data

Financial data are all in Euro (€), fixed prices, at the 2015-level and exclude value added taxes (VAT) and other taxes. Several data originate in Danish references. For those data a fixed exchange rate of 7.45 DKK per € has been used.

European data, with a particular focus on Danish sources, have been emphasized in developing this catalogue. This is done as generalizations of costs of energy technologies have been found to be impossible above the regional or local levels, as per IEA reporting from 2015 [ref. 3]. For renewable energy technologies this effect is even stronger as the costs are widely determined by local conditions.

Investment costs

The investment cost is also called the engineering, procurement and construction (EPC) price or the overnight cost.

The investment cost for transmission systems is reported on a normalized basis both in terms of rated power and length of transmission lines, i.e. cost per MW per m.

Where possible, the investment cost is divided on equipment cost and installation cost. Equipment cost covers the components and machinery including environmental facilities, whereas installation cost covers engineering, civil works, buildings, installation and commissioning of equipment.

The rent of land is not included but may be assessed based on the space requirements, if specified in the qualitative description.

The owners' predevelopment costs (administration, consultancy, project management, site preparation, approvals by authorities) and interest during construction are not included. The costs to dismantle decommissioned installations are also not included. Decommissioning costs may be offset by the residual value of the assets.

The investment costs for energy distribution systems can be described as:

- A total network cost for an area with a certain yearly consumption (according to area types),
or
- Split into service line costs, single line costs, station costs, and possibly reinforcement costs

The investment costs for a total distribution system may thus be composed of a combination of networks of different area types, and/or a combination of single components located outside the defined areas, as considered relevant for the specific model purpose.

For transmission systems the network costs and service line costs are not relevant.

The investment costs for establishing new energy transport systems depend on many local and regional factors. For some installations, e.g. burial of cables and pipes, experience shows that the price levels are higher in the Eastern part of Denmark, especially near Copenhagen, than in the rest of the country. Furthermore, costs increase considerably in city areas where many lines may be buried next to or over each other, and traffic regulation is more complicated. Also, burial of lines in paved areas is usually considerably more expensive than burial in open land.

Also there may be variations of the energy densities within each area type. For instance, a newly developed area (area type a) could consist mainly of multi-apartment building, or mainly of single family houses.

For distribution systems such variations within each area type can be accounted for by correction factors stated in the notes in the bottom of the sheets. The uncertainty values are not intended to cover these variations.

Service line costs

The cost of service lines are stated per consumer connected.

The costs include connection to the main lines and termination inside or outside the building, typically with a metering device and an isolation device (valve, contactor etc.). The data do not show whether the costs are paid by the distribution company or the consumer.

The costs of service lines depend mainly on the installed capacity, the length of the lines, and the area type. In this context average (typical) lengths have been assumed, depending on the size of the customers rated power/heat/flow capacity:

- a) 0-20 kW: 20 m (for example, actual values to be stated)
- b) 20-100 kW: 50 m (for example, actual values to be stated)
- c) Above 100 kW: 100 m (for example, actual values to be stated)

If the lengths of lines differ from these values their costs can be scaled with length.

The service line costs are usually lower in new development areas, where the buildings as well as the distribution grid is new, corresponding to area 'type a'.

Distribution network costs

The costs to establish distribution networks depend on the installed capacity, which with a typical load profile corresponds to a yearly energy demand. Thus, the costs are counted in EUR/MWh/year. The influence of varying energy consumption densities of different areas is accounted for by selecting the values from the data sheet with the appropriate area type.

Single line costs

The single line investment costs for distribution systems are unit length costs (EUR/m) for lines within certain capacity ranges (MW). These values can supplement the general network costs, e.g. in case of connecting isolated distribution areas with distribution lines, or for connection of single (larger) consumers. Thus, the investment cost for a distribution line is found by multiplying the length with the cost for the appropriate capacity interval.

For transmission systems, the line investment costs are counted in unit length and unit power capacity costs (EUR/MW/m) for different capacity ranges. Thus, the investment cost for a transmission line is found by multiplying the length and capacity with the cost for the appropriate capacity interval.

Reinforcement costs

Reinforcement costs are the average unit cost of reinforcing a distribution or transmission network with one MW capacity at the consumer level. This may be relevant in cases where the consumers in an existing distribution system has a higher capacity demand due to altered energy use, for instance application of heat pumps for domestic heating.

Stations

The investment costs of relevant station types in distribution and transmission systems are given in unit cost per MW capacity. The type of station is stated in the data sheets. If more than one type of station is relevant for a technology, they are mentioned in separate rows in the table.

Percentage installation / materials

For the complete distribution or transmission system it is assessed how large a share of the total investment is installation costs, and how large a share is materials. The two shares together should equal 100 percent.

Operation and maintenance (O&M) costs.

The fixed share of O&M includes all costs, which are independent of how many hours the components are operated, e.g. administration, operational staff, payments for O&M service agreements, property tax, and insurance. Any necessary reinvestments to keep the infrastructure operating within the technical lifetime are also included, whereas reinvestments to extend the life are excluded. Reinvestments are discounted at 4 % annual discount rate in real terms. The cost of reinvestments to extend the lifetime may be mentioned in a note if data are available.

The variable O&M costs include consumption of auxiliary materials (water, lubricants) and electricity, treatment and disposal of residuals, spare parts and output related repair and maintenance (however not costs covered by guarantees and insurances).

The variable O&M is in most cases very low for transmission and distribution systems and it is mainly constituted by auxiliary consumption. Where auxiliary consumption is not relevant, e.g. for electricity, this figure could equal zero.

Planned and unplanned maintenance costs may fall under fixed costs (e.g. scheduled yearly maintenance works) or variable costs (e.g. works depending on actual operating time), and are split accordingly, if relevant.

The operation costs do not include energy losses.

Auxiliary electricity consumption is included in the variable O&M for district heating and gas (natural gas, hydrogen, biogas/syngas) technologies. The electricity price applied is specified in the notes for each technology, together with the share of O&M costs due to auxiliary consumption. This enables corrections from the users with own electricity price figures. The electricity price does not include taxes and PSO.

It should be noted that O&M costs often develop over time. The stated O&M costs are therefore average costs during the entire lifetime.

For distribution systems the fixed costs are counted per MW capacity per year (€/MW/year), and the variable costs are counted per MWh delivered to the distribution network (€/MWh).

For transmission systems the fixed costs are counted per MW capacity per km transmission line at the relevant level (€/MW/km/year), and the variable costs are counted per MWh transported per km of line (€/MWh/km).

Technology specific data

Additional data is specified in this section, depending on the technology.

This could for instance be the necessary width and depth of the trench for burial of lines, the height and spacing of masts for overhead lines, the typical diameters of pipes of certain capacity ranges, transformer electrical losses depending on loads, heat losses depending on pipe classes, etc.

For technologies related to transmission of electricity, the cost of overload is specified.

It represents the cost in terms of degradation of the line due to overheating caused by an overload of the line and can be used for example to calculate the convenience of overloading an existing line vs. building a new one.

The unit and calculation method is specified in a note to the table.

1.4. Definitions

Definitions of the transmission and distribution systems, as well as different area types and transmission levels, are given in the Introduction.

1.5. References

Numerous reference documents are mentioned in each of the technology sheets. Other references used in the Guideline are mentioned below:

1. Danish Energy Agency: "Forudsætninger for samfundsøkonomiske analyser på energiområdet" (Generic data to be used for socio-economic analyses in the energy sector), May 2009.
2. "Projected Costs of Generating Electricity", International Energy Agency, 2015.
3. "Konvergensprogram Danmark 2015". Social- og Indenrigsministeriet. March 2015.
4. "Energy Technology Perspectives", International Energy Agency, 2012.
5. International Energy Agency. Available at: <http://www.iea.org/>. Accessed: 11/03/2016.

111 Electricity distribution grid

Contact information:

Danish Energy Agency: Rikke Næraa, rin@ens.dk

Energinet.dk: Rune Duban Grandal, rdg@energinet.dk

Author: Oskar Fångström, oskar.d.fangstrom@sweco.se

Reviewer: Katarina Yuen, Katarina.yuen@sweco.se

Publication date

December 2017

Amendments after publication date

Date	Ref.	Description
-	-	-
-	-	-

Qualitative description

Brief technology description

The electrical grid is an interconnected network that delivers electricity from suppliers to consumers. It consists of generators that produce electrical power, transmission lines that transport large quantities of power over large distances within a country or between countries, and distribution networks that distribute electricity at lower power levels to end users. Electricity transport is carried out at different voltage levels.

Voltage transformation is carried out by transformers in transformer stations. Higher voltages enable transport of larger amounts of power at low loss and transmission lines use voltage ranges from hundreds of kilovolts and up. Near customers the voltage is reduced in several steps by step-down transformers and transported by distribution line to users. The major components of an electric power system are illustrated in figure 1 [1].

The electrical grid is a fundamental part of the infrastructure in all developed countries. The electrical grid enables interconnection of a large numbers of producers and consumer, which results in a flexible system with very high reliability. Interconnected electrical networks also pave the way for introduction of large amounts of renewable electricity sources.

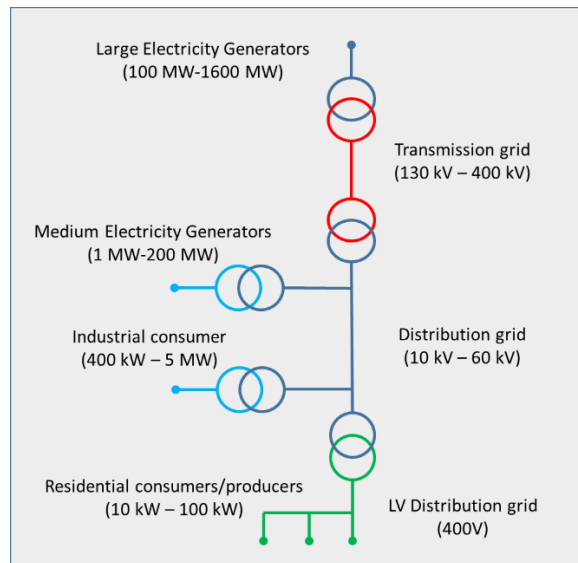

Figure 1: Major components in an electric power grid

Input

Historically, electrical power is generated at utility scale by electrical power plants such as thermal power plants, hydropower plants, and nuclear power plants with power levels in the range of a few hundred kW up to 1000 MW levels. Thermal power plants and nuclear power plants use fuel (fossil fuel, biofuel, nuclear fuel) as a primary energy source, which is used to heat water into steam that drives a turbine-generator set that produces electricity. Thermal plants, especially gas power plants, have high ability to regulate power. Hydropower uses potential energy of water in rivers to drive turbine-generator sets. Hydropower has a high ability to regulate power and can regulate power on sub-second levels. The water in the dams of hydropower plants represents an energy storage that can be used to balance power on a yearly basis. The turbine-generator sets of thermal, nuclear and hydropower plants have, thanks to the large masses and high rotating speed, a significant inertia. This inertia provides stability to the power system and is an important factor for grid stability and reliability. Utility scale power plants are connected directly to the transmission network by a step up transformer and are often situated away from demand centers.

Over the last 30 years there has been an increase of renewable electricity generators, which has accelerated the last 15 years. Since 2007 the share of solar photovoltaics (PV) and wind power have represented over 50 % of new power capacity installed in Europe. In 2015 22 GW capacity of renewable electricity was installed, representing 77 % of all capacity installations in Europe that year [2]. Denmark has been a pioneer in developing commercial wind power. In 2015 wind power produced the equivalent of 42 % of Denmark's total electricity consumption, the highest proportion for any country [3]. Wind power plants and solar power plants have powers ranging from a few MW to several 100 of MW. Smaller plants are connected to the distribution grid but larger plants are connected to the transmission grid. Unlike traditional power plants, regulating capacity and inertia is limited for wind power and PV.

An increasing trend is domestic PV, where private households and commercial buildings have a few kW of installed PV on the rooftop. The PV facility is connected to the low voltage system of the building and the power is used by the owner and surplus delivered to the electrical grid.

Output

Electric power has a vast usage in the residential, commercial and industrial sector. In the residential sector electricity is used for lighting, washing, refrigeration, cooking, heating and entertainment. Average energy consumption per capita in Denmark is 1,600 kWh per year. This is dominated by entertainment (tv, computer, stereo, etc.), which accounts for 40% of electricity consumption. Electricity usage for heating (direct, central electric heating and heat pumps) is low in Denmark (4%) compared to *e.g.* Sweden where 30 % of the energy used for heating is electrical energy. The commercial sector uses electricity for lighting, ventilation, cooling and heating, refrigerators, computers, etc. The industrial sector uses electricity to drive machinery, processes and boilers. The transportation (cars, trains, trams and subways) sector represents a small part of total electricity usage in Denmark (1.5%) [4] [5] [6].

Energy balance

In an electrical system all the electricity production needs to be continuously balanced with the consumption and losses. The transmission system operator (TSO) is responsible for this balance and maintains a second-by-second balance between electricity production supply from producers and demand from users. Intraday balance is handled by the electricity market where production supply is purchased based on projected demand. Fluctuation in shorter time frames is handled by a regulating power market, where changes in production and consumption can be carried out on second, minute and hour basis. Energinet.dk is the TSO of Denmark and is in charge of ensuring the physical balance of the Danish electric power system. Energinet.dk is part of the common Nordic regulating power market [7]. Introduction of large amounts of intermittent power increases the need for regulation. As a result, electric energy storage is implemented on utility scale in *e.g.* UK [8]. Electricity transportation incurs losses in the form of thermal losses in the conductors. The total energy loss of an electrical system lies in the range of 6%-10% in developed countries [9] [10] [11]. In Denmark the total losses vary between 6%-9.5%, where 1%-2% stem from the transmission grid and 4%-6.5% stem from the distribution grid.

Description of transmission system

The electrical transmission system is used for bulk transport of power at large distances and to interconnect large areas. The transmission system operates at high voltages, typically 110kV-1000kV, and the power capacity ranges from 100 MW to several GW. The transmission grid in Denmark operates at 132 kV to 400 kV. The transmission grid consists mainly of overhead lines, but high voltage cables are increasing in share especially in densely populated areas. Transformer stations step up and down voltages between different parts of the transmission network and to producers and distribution grids. Compensation stations are used to enhance controllability and increase power transfer capacities of the transmission grid. Capacitive or reactive power is provided by means of capacitor banks, flexible alternating current transmission systems (FACTS), etc. High Voltage DC connections are used in the transmission grid to transport large amounts of energy long distances. HVDC connections can also be used to interconnect regions with different frequencies. Transmission systems

interconnect vast areas into synchronous grids, where a large number of generators deliver power with the same electrical frequency to a large numbers of users. Denmark has two separated transmission systems, of which the eastern one is synchronous with Nordic countries and the western one is synchronous with the grid of Continental Europe [12]. Large interconnected transmission systems enable optimal power dispatch between a large number of power generators with different characteristics, enhance system reliability, and are necessary to efficiently handle an increasing amount of intermittent energy sources.

Description of distribution system

An electric power distribution system carries electricity from the transmission system to individual users. Distribution substations connect the distribution grid with the transmission grid and steps down the voltage to medium voltage, typically 10 – 70 kV. In secondary substations, distribution transformers make a final step down in voltage to low voltage (400V), distributed by service lines to end users. Users demanding larger amounts of powers can be directly connected to the medium voltage, or even higher voltage levels. Traditionally, medium voltage distribution was composed of overhead lines, which have a lower degree of technical complexity. A significant cabling of the medium voltage grid has taken place in Denmark and neighboring countries. Drivers being increased security of supply and reduced visual pollution.

Space requirement

Space requirement for overhead lines varies in agricultural land, forest and habituated areas. In agricultural land the space requirement is limited to the poles and stays. In forest a 400 kV overhead line needs a clearance of 40 m – 50 m where no trees are allowed to grow and additional 10 meter on each side where tree height is limited. In populated areas a clearance zone of 38 meter width is set for non-residential buildings, whereas a clearance of approximately 200 m width is required for buildings where human reside permanently in order to avoid exposure of magnetic fields. The space requirement reduces with lower voltages and for distribution grid the clearance in forest ranges from 4 - 22 m width [13] [14]. Electric cables have a significantly lower space requirement. In populated areas and cities, cables are normally laid close to or in roads and streets. Ground cables do not affect the use of agricultural land. As far as possible, medium voltage cables follows roads also in rural areas. In forest, a clearance is required to provide easy access to the cable and to avoid tree roots from damaging the cable. For transmission grids this clearance is 10 m – 15 m and for distribution grids the clearance is 4 m. The magnetic field from cables is smaller than for overhead lines and does not add to the space requirements.

	Agricultural land	Forest	Populated area
Transmission overhead lines	negligible	0,1-0,35	0,3-2
Transmission cables	negligible	0,02-0,1	0,02-0,1
Distribution overhead lines	negligible	0,4-1,1	1 - 3
Distribution cables	negligible	0,1-0,2	0,1-0,2

Table 1: Space requirements, square meter per MW per meter.

Advantages/disadvantages

Electricity is an essential part of modern life and the electric grid is a natural and integral part of the infrastructure in developed countries. High voltage transmission grids enable long distance

transportation of vast amounts of energy with 97% to 98% efficiency. The transmission grid forms, together with the distribution grids, a power transmission system that enables energy transportation from a range of different electricity production facilities to a large range of end users. The end-to-end efficiency of the electricity system ranges between 90% to 94% and the reliability is very high. The Danish security of supply of electrical power is 99,996%, which corresponds to an average outage of electricity of 15 minutes per year [15]. Furthermore, a large, integrated electrical grid is a prerequisite for increased amounts of intermittent renewable electricity, such as wind and solar power. This will be essential in the transition to fossil-free energy systems [16].

On the contrary, electric energy production in the EU is still dominated by non-renewable energy sources such as fossil fuels and nuclear plants. In order to increase the renewable electricity share the electrical grids needs to be more flexible and the level of integration between regions needs to be increased further.

HVDC vs HVAC

A vast majority of electric transmission systems today use three phase High Voltage Alternating Current (HVAC). A majority of the electricity is produced, transferred and consumed as AC power. Furthermore, the voltage of AC power can be stepped up and down with relative ease. Technology development has enabled the use of High Voltage Direct Current as a highly efficient alternative for transmission of electric power and for interconnecting power grids with different frequencies. HVDC requires terminal converter stations with relatively high costs, which is not required by HVAC. The cost per distance is however lower for HVDC systems, due to smaller space requirements, reduced number of conductors and reduced losses. HVDC also enables longer cable transmission due to the lack of capacitive losses that are apparent in AC cables. Above a specific distance, called break-even distance, HVDC technology becomes cheaper than HVAC. The break-even distance for overhead lines is around 600 km and for cables lines it is around 50 km. HVDC also enables a number of additional benefits, such as enhanced voltage regulation and controllability, ability to interconnect regions with different frequencies, reduced short circuit current in AC system, etc. Often the choice between HVDC and HVAC is based on economical, technical and environmental judgments [17] [18].

Overhead lines vs cables

A majority of the transmission grid is composed of overhead lines. Overhead lines offer significantly lower construction costs and lower capacitive losses. On the contrary, the space requirements of overhead lines are significantly larger than for cables (200 m vs 15 m) and visual impacts are significant. For high voltage long distance transfer in unpopulated areas, overhead lines are often the preferred choice. In populated area, cables can provide an attractive solution, mainly due to the small land intrusion. In densely populated areas, cables often provide the only technically viable solution. The transmission grid in Denmark consists of 4,900 km of overhead lines and 1,900 km of cables [19] [20].

Distribution grids have seen a significant change towards underground cables. The motivation for this is the increase in reliability that is provided by avoiding overhead lines, sensitive to storms. Cabling of the distribution grid in Denmark has already had noticeable effect on system reliability. While cables in distribution grids are less susceptible to faults, once a fault has occurred it is more difficult to locate and amend than if the fault is in an overhead line.

Environment

The environmental impacts of the electrical grid are mainly [21]:

- Visual impacts – Overhead lines are often considered to have a negative aesthetic impact on the surroundings
- Electromagnetic fields – Electricity infrastructure produces both electric and magnetic fields that may be harmful. Exposure to electric and magnetic fields are regulated and appropriate safety distances are assured when establishing electrical transmission infrastructure.
- Noise – Sizzles, crackles and hissing noises occur around high voltage overhead lines during periods of high humidity. Transformers emit humming sounds. These noises are audible only at close vicinity to the equipment. Noise during construction and maintenance can have an impact on the environment.
- Intrusion in sensitive areas – The environmental impact due to intrusion can be minimized by *e.g.* avoiding placement in sensitive areas, limiting construction to winter when soils and water are more likely to be frozen and vegetation is dormant, etc.
- Electrical hazard – Safety requirements on design and operation are established to assure safe design and operation of electric facilities.

Research and development perspectives

The electric power system in Europe is changing. The main drivers of the changes are climate policy and technological developments. Climate policy has stimulated the development of new renewable energy sources. The share of wind and solar power has increased from a marginal level in the end of the 20-th century to an impressive 26 % of the EU power mix in 2015. This represents a significant change to the electric power system in Europe and the electric grid plays a central role as facilitator for the ongoing and continuing expansion of large amounts of intermittent energy sources [2][16][22]. Some of the ongoing research and development activities in this area are listed below:

- Development of a common European framework for market operation and planning.
- Implementation of Smart grids with a significant level of customer flexibility
- Energy storage – both decentralized and at utility scale. Electric energy storage is currently at a very low level in Denmark. Price development for batteries and the need for system services, such as frequency control, have today resulted in commercial utility scale battery storages in *e.g.* UK and US. It is has also become economically attractive in an increasing part of the world for households to install local battery storages in combination with solar PV.

Examples of market standard technology

Skagerrak 4 – Submarine HVDC-light interconnection between Denmark and Norway. The link has a voltage rating of 500 kV and a capacity of 700 MW. The link is composed of two converter stations, 90 km of land cables and 130 km of submarine cables. It will enable more renewable electricity and more efficient use of electricity [23][24].

SouthWest link - A combined AC- and DC transmission line connecting the South of Sweden with Central Sweden. The link is composed of three AC substations, two converter stations, underground cables and overhead lines. The total capacity will be 2 x 600 MW and the total length is 430 km [25].

Prediction of performance and costs

Predictions of cost are made from two data sets:

- EBR cost data base which is a complete, detailed and precise cost data base covering labor cost, material cost and O&M in the Swedish power grid sector [26].
- Standard value list for the Swedish Energy Markets Inspectorate, which is an unbiased and detailed database of costs in the power grid sector developed by the regulatory authority [27].

Data are correlated to Danish market conditions by benchmarking key figures with Danish project experiences.

The electricity grid is a mature and commercial technology with large deployment. Price fluctuations have been low during recent years and the price development has more or less stabilized over the last six years. No large changes in costs and performance are expected to happen on current technology in the foreseeable future. However, new technology, changes in production methods and changes consumption behavior will possibly overturn the prerequisites of our current electrical grid.

Uncertainty

Performance data of electrical grid, such as energy losses, technical life time and load profile typically depends on techno-economic-political considerations such as amount of energy transfer to adjacent countries, value of energy loss, life time vs. investment costs, etc. Changes in regulations, economic and political foundations may have impact on the performance data. Furthermore, large changes on the basic design and operation of the grid will have impact on both performance and costs that are difficult to anticipate.

References

- [1] Electrical grid, Wikipedia (https://en.wikipedia.org/wiki/Electrical_grid)
- [2] Wind in power 2015 European statistics, European Wind Energy Association (<https://windeurope.org/wp-content/uploads/files/about-wind/statistics/EWEA-Annual-Statistics-2015.pdf>)
- [3] New record-breaking year for Danish wind power, energinet.dk, 15 January 2016. (<http://energinet.dk/EN/El/Nyheder/Sider/Dansk-vindstroem-slaar-igen-rekord-42-procent.aspx>)
- [4] Energistyrelsen, Hvor meget el bruger du? (<http://spareenergi.dk/forbruger/el/dit-elforbrug>)
- [5] US Energy Information Administration, Use of electricity (https://www.eia.gov/energyexplained/index.cfm?page=electricity_use)
- [6] Danish Electricity Supply '08 Statistical Survey, Danish Energy Association, 2008.
- [7] Regulation C2: The balancing market and balance settlement, Energinet.dk, 2008.
- [8] National Grid brings forward new technology with Enhanced Frequency Response contracts, national Grid (<http://media.nationalgrid.com/press-releases/uk-press-releases/corporate-news/national-grid-brings-forward-new-technology-with-enhanced-frequency-response-contracts/>)

Data sheets

Table 1: Main distribution, 50/60 kV electricity

Technology	Electricity Main distribution, electricity cables									
	2015	2020	2030	2050	Uncertainty (2020)		Uncertainty (2050)		Note	Ref
Energy/technical data					Lower	Upper	Lower	Upper		
Energy losses, lines 1-20 MW (%)	0,30	0,30	0,30	0,30	0,30	0,5	0,15	0,5	A,B	1,2,3,4
Energy losses, lines 20-100 MW (%)	0,30	0,30	0,30	0,30	0,30	0,5	0,15	0,5	A,B	1,2,3,4
Energy losses, lines above 100 MW (%)	0,30	0,30	0,30	0,30	0,6	0,5	0,15	0,5	A,B	1,2,3,4
Energy losses, stations [Type 1] (%)	0,2	0,2	0,2	0,2	0,2	0,25	0,1	0,25	A,B	1,2,3,4
Energy losses, stations [Type 2] (%)	N/A	N/A	N/A	N/A	N/A	N/A	N/A	N/A	A,B,S	
Auxiliary electricity consumption (% energy transmitted)	N/A	N/A	N/A	N/A	N/A	N/A	N/A	N/A	A,B,S	4
Technical life time (years)	40	40	40	40	35	40	40	50	C	5
Typical load profile (-)	45%	45%	45%	45%	45%	45%	42%	54%	D	
Construction time (years)	1,5	1,5	1,5	1,5	1	5	1	5	E	
Financial data										
Investment costs; single line, 0 - 50 MW (EUR/MW/m)	6,0	6,0	6,0	6,0	5,4	6,0	4,86	6,0	F,G	6,7
Investment costs; single line, 50-100 MW (EUR/MW/m)	3,9	3,9	3,9	3,9	3,51	3,9	3,159	3,9	H,G	6,7
Investment costs; single line, 100 - 250 MW (EUR/MW/m)	3,1	3,1	3,1	3,1	2,79	3,1	2,511	3,1	I,G	6,7
Investment costs; single line, 250-500 MW (EUR/MW/m)	N/A	N/A	N/A	N/A	N/A	N/A	N/A	N/A	J	6
Investment costs; single line, 500-1000 MW (EUR/MW/m)	N/A	N/A	N/A	N/A	N/A	N/A	N/A	N/A	J	7
Investment costs; single line, above 1000 MW (EUR/MW/m)	N/A	N/A	N/A	N/A	N/A	N/A	N/A	N/A	J	8
Reinforcement costs (EUR/MW)	15.800	15.800	15.800	15.800	15073	15800	14380	15800	K,O	6
Investment costs; [type 1] station (EUR/MW)	76.000	76.000	76.000	76.000	72504	76000	69169	76000	L,O	8
Investment costs; [type 2] station (EUR/MW)	4476	4476	4476	4476	4270	4476	4074	4476	M,O	
Investments, percentage installation	42%	42%	42%	42%	37%	42%	33%	42%	P	6
Investments, percentage materials	58%	58%	58%	58%	58%	63%	58%	67%	P	6
Fixed O&M (EUR/MW/km/year)	22,1	21,8	21,5	21,2	21,7	22,1	20,9	22,1	Q	9
Variable O&M (EUR/MWh/km)	N/A	N/A	N/A	N/A	N/A	N/A	N/A	N/A	R	

Notes

- A Energy losses are estimated from total energy loss on transmission levels in the voltage range 20kV to 130 kV in Sweden. Transmission lines/cables accounts for approximately 60% of the losses and transformers accounts for approximately 40%.

- B Development of energy loss over time depends on several factors. Today, transmission losses typically range between 1% to 3% in Denmark. The variation in transmission losses depends mainly on the amount of power transfer to neighboring countries. The trend in Denmark is towards increasing transfer and thus increasing losses. The uncertainty span for 2020 mainly takes changes in power transfer into account, where the lower bound corresponds to a reduction of power transfer to a 1998 level, and the upper bound corresponds to a continued increase in losses stemming from increased power transfer.
- Technology development with introduction of e.g. super conducting transformers and super conducting power lines could lead to reduced losses on transmission level. Other factors, such as load control/optimization could also reduce losses in generators due to increased load factor. This technology development is not anticipated to have effect before 2020, but is possible in a second upgrade of electricity system in 2050.
- C Cable life length depends on material characteristics and the thermal loading of the cable. Increasing cable area and thus reducing cable temperature leads to longer life length. Today, up to 40 years are realistic life length of a cable with moderate thermal loading. Technological development on cable materials is anticipated to give an increase in cable life length. This in combination with low thermal loadings could give life length of up to 50 years in the future.
- D Load profile varies significantly between different stations and cables and a general figure is given. The load profile is not expected to change to 2020. For 2050 the upper scenario is a smart grid scenario, in which the load factor increases by 6 %, the lower scenario is an increase in peak load without the use of smart grid leading to a decrease in load factor by 20%.
- E Construction time ranges normally from 1 to 2 years. In technically complex projects and for long cable stretches, the construction time increases and could stretch up to 5 years.
- F Costs are based on data for cables with design voltage of 72 kV and a operation voltage of 50 kV. Cost is calculated as the average cost between rural areas, dense populated areas and city areas. Adjusting factors for each area are: rural areas: 0,75, dense populated: 1,04, and city: 1,2.
- For power range 0 - 50 MW the costs is calculated as the average cost of two cables types with cross section areas 240 mm² and 630 mm², corresponding to power levels of 20-35 MW and 50-60 MW respectively. The cost per MV decreases with increasing power level. The interval 20-35 MW has a cost of 6,7 EUR/MW/m and the interval 50-60 MW a cost of 4,2 EUR/MW/m. An increase in operation level to 60 kV will decrease the cost by a factor 0,9. Power level below 20MW is not considered for this voltage level.
- G Price projections are based on an extrapolation of price development over the years 2000 - 2014 corrected for inflation. Over the six last years the prices have stabilized on a constant level and it is assumed that prices will remain stable. Lower uncertainty bounds for 2020 assumes a reduction of 10% of the costs due to more efficient installations and a continued reduction by an additional 10% for 2050. No increases in costs are anticipated and upper bounds are set to today's level for both 2020 and 2050.
- H Costs are based on data for cables with design voltage of 72 kV and a operation voltage of 50 kV. Cost is calculated as the average cost between rural areas, dense populated areas and city areas. Adjusting factors for each area are: rural areas: 0,75, dense populated: 1,04, and city: 1,2. For power range 50-100 MW the costs is calculated as the average cost for three cables with cross section areas 630 mm², 800mm² and 1000 mm², corresponding to power levels of 50-60 MW, 69 MW and 76 MW respectively. The cost per MV decreases with increasing power level. The power interval 50-60 MW has a cost of 4,2 EUR/MW/m, at power level of 69 MW the cost is 3,6 EUR/MW/m and at the power level 76 the cost is 3,4 EUR/MW/m. An increase in operation level to 60 kV will decrease the cost by a factor 0,9.

- I Costs are based on data for cables with design voltage of 72 kV and a operation voltage of 60 kV. Cost is calculated as the average cost between dense populated areas and city areas. Adjusting factors for each area are: dense populated: 0,94, and city: 1,06. For power range 100-250 MW the costs is given for a cable with cross section area of 1200 mm², corresponding to a power level of 100 MW. Power levels above 100 MW are not considered for this voltage level.
- J Power levels above 100 MW are normally transported at higher voltage levels. In cases where it is motivated to transport higher power levels at 50/60 kV, this is done in parallele cable budles in the same shaft. The cost of two parallel cables can be calculated as the double cost of one cable reduced with 60 800 EUR per kilometer.
- K Reinforcement costs depends on where bottlenecks are situated in the grid. Here the reinforcement cost is given for an upgrade of transformer capacity by 40 MVA. Reinforcement of line/cable capacity is in parity with the investment cost in described in row 18 - 20 and depends on power level and cable length.
- L Station cost is based on a 40 MW station with 2 x 20 MVA transformers (72/12 kV). Station cost depends on a number of factors, such as power rating, redundancy on transformers etc. Station cost have an almost linear relation to the power rating and following relation holds for the power span 20 - 126 MW: Station cost (EUR) = 16 000 (EUR/MW) x Power rating (MW) + 2 350 000 (EUR). Using a single transformer instead of two reduces the cost by a factor 0,86 - 0,87.
- M Station cost is based on average cost for capacity banks and inductor with a design voltage of 72 kV. It is assumed that the equipment is installed in a existing station.
- O Price projections are based on an extrapolation of price development over the years 2000 - 2014 corrected for inflation. Over the six last years the prices have stabilized on a costant level and it is assumed that prices will remain stable. Lower uncertainty bounds for 2020 assumes a reduction of 4,4% of the costs due to more efficient installations and a continued reduction by an additional 4,4% for 2050. No increases in costs are anticipated and upper bounds are set to today's level for both 2020 and 2050.
- P The percentage of the investment cost allocated to material cost and installation cost varies depending on area type (rural or city) and power level. An average is given here. Lower uncertainty bounds for 2020 assumes a reduction of 17,6% of the investment costs due to more efficient installations and a continued reduction by an additional 10% for 2050.
- Q The fixed O&M cost are calculated as a standard annual cost of 0,51% of the investment cost multiplied by the average cost of cables per MW and km given in row 18 to 20. It should be noted that the O&M cost in distribution system mainly is attributed to stations since there is practically no maintenance on cables. The O&M cost is assumed to be reduced over time by an annual factor of 1 - 1,8% due to increased efficiency. Upper uncertainty bounds for 2020 and 2050 corresponds to no efficiency increase in O&M and lower bounds corresponds to a continuous annual efficiency increase of 1,8%
- R Variable O&M cost is in very low for electric transmission systems and considered to be negligible
- S Energy losses and auxiliary electricity consumption can be considered negligible

References

- 1 U.S. Energy Information Administration (<http://www.eia.gov/tools/faqs/faq.cfm?id=105&t=3>)
- 2 energinet.dk (<http://www.energinet.dk/DA/KLIMA-OG-MILJOE/Energinetdks-miljoepaavirkninger/Miljoepaavirkninger-ved-transport-af-el/Sider/Tab-i-elnettet.aspx>)
- 3 Svenska Kraftnät, Nätutvecklingsplan 2016 – 2025, Oktober 2015 (<http://www.svk.se/siteassets/om-oss/rapporter/natutvecklingsplan-2016-2025.pdf>)
- 4 International Electrotechnical Commission, Efficient Electrical Energy Transmission and Distribution (<http://www.iec.ch/about/brochures/pdf/technology/transmission.pdf>)
- 5 Svenska Kraftnät, Technology (<http://www.svk.se/en/grid-development/the-construction-process/technology/>)
- 6 EBR cost database, developed by Swedish bransch organisation Svensk Energi.
- 7 PEX Guiden, Ericsson
- 8 Standard value list for the Swedish Energy Markets Inspectorate (2015 value) (<http://ei.se/sv/el/Elnat-och-natprisreglering/forhandsreglering-av-elnatstariffer-ar-2016-2019/dokument-elnatreglering/normvardeslista-elnat-2016-2019/>)
- 9 Swedish Energy Markets Inspectorate (<http://ei.se/sv/el/Elnat-och-natprisreglering/de-olika-delarna-i-intaktsramen/>)

Table 2: Electricity distribution, Rural

Technology	Electricity Distribution, Rural									
	2015	2020	2030	2050	Uncertainty (2020)		Uncertainty (2050)		Note	Ref
Energy/technical data					Lower	Upper	Lower	Upper		
Energy losses, lines (%)	5,25	5,25	5,25	5,25	5,25	5,25	4,5	5,25	A	1
Energy losses, stations (%)	1,13	1,13	1,13	1,13	0,75	1,5	0,75	1,5	B	2
Auxiliary electricity consumption (% of energy delivered)	N/A	N/A	N/A	N/A	N/A	N/A	N/A	N/A	N	3
Technical life time (years)	40	40	40	40	35	40	35	50	C	4, 5
Typical load profile (-)	44%	44%	44%	44%	44%	44%	33%	47%	D	1, 5
- Residential	44%	44%	44%	44%	44%	44%	33%	47%	D	
- Commercial	44%	44%	44%	44%	44%	44%	33%	47%	D	
Construction time (years)	1	1	1	1	1	2	1	2		5
Financial data										
Distribution network costs (EUR/MWh/year) Rural	173	173	173	173	156	173	132	206	E,F	1, 6
Investment costs; service line, 0 - 20 kW (EUR/unit)	524	524	524	524	472	524	424	524	G,F	6
Investment costs; service line, 20 - 50 kW (EUR/unit)	1412	1412	1412	1412	1271	1412	1144	1412	G,F	6
Investment costs; service line, 50-100 kW (EUR/unit)	1583	1583	1583	1583	1425	1583	1282	1583	G,F	6
Investment costs; service line, above 100 kW (EUR/unit)	3745	3745	3745	3745	3371	3745	3033	3745	G,F	6
Investment costs; single line, 0-50 kW (EUR/m)	N/A	N/A	N/A	N/A	N/A	N/A	N/A	N/A	H,F	
Investment costs; single line, 50-250 kW (EUR/m)	N/A	N/A	N/A	N/A	N/A	N/A	N/A	N/A	H,F	

Investment costs; single line, 100-250 kW (EUR/m)	36	36	36	36	32	36	29	36	H,F	6
Investment costs; single line, 250 kW - 1 MW (EUR/m)	36	36	36	36	32	36	29	36	H,F	6
Investment costs; single line, 1 MW - 5 MW (EUR/m)	41	41	41	41	37	41	33	41	H,F	6
Investment costs; single line, 5 MW - 25 MW (EUR/m)	88	88	88	88	85	88	77	88	H,F	6
Investment costs; single line, 25 MW - 100 MW (EUR/m)	N/A	N/A	N/A	N/A	N/A	N/A	N/A	N/A	H,F	
Reinforcement costs (EUR/MW) (Station)	11500	11500	11500	11500	10994	11500	10510	11500	I,F,J	6
Investment costs; [type 1] station (EUR/MW)	67500	67500	67500	67500	64530	67500	61691	67500	J	6
Investment costs; [type 2] station (EUR/MW)	N/A	N/A	N/A	N/A	N/A	N/A	N/A	N/A		
Investments, percentage installation (cables)	62%	62%	62%	62%	57%	62%	53%	62%	K	6
Investments, percentage materials (cables)	38%	38%	38%	38%	38%	43%	42%	38%	K	6
Investments, percentage installation (stations)	22%	22%	22%	22%	19%	22%	17%	19%	K	6
Investments, percentage materials (stations)	78%	78%	78%	78%	78%	81%	78%	81%	K	6
Fixed O&M (EUR/MW/year)	1628	1605	1583	1560	1599	1628	1541	1628	L	7
Variable O&M (EUR/MWh)	N/A	N/A	N/A	N/A	N/A	N/A	N/A	N/A	M	

Notes

- A The line losses were calculated using reference (1) and the formula Total energy exported to customer / Total energy fed into the system. Lines in rural areas have a higher loss than lines in more populated areas.
- B Losses in a transformer tends to decrease with increasing transformer capacity. The losses also depends on the transformer load. When the transformer load decreases under 20 % there is a large increase in the losses. In general the losses are about 1-2 %
- C According to the network price regulation from Energimarknadsinspektionen, the technical life time for stations and cables are 40 years. In practice, cable technical life can be shorter, depending on the thermal loading of the cable.
- D Calculations for the load profile were based on reference (1). This gave an average value of 44 % for all areas. The load profile is not expected to change to 2020. For 2050 the upper scenario is a smart grid scenario, in which the load factor remains the same, the lower scenario is an increase in peak load without the use of smart grid leading to a decrease in load factor by 19%.
- E The distributions network costs are based on the average station cost and cable cost per customer divided by the average yearly energy transported to a customer. Assumptions on the average cable length per customer and the average number of stations per customer could be translated to a total distribution network cost per customer using the EBR cost database. Cost per MWh are affected both by changes in actual costs and changes in load factors. In 2020 load factors are assumed to be constant. Lower bounds assumes a reduction of 10% of the costs due to more efficient installations, no cost increased is assumed. For 2050 the lower bounds corresponds to a smart grid scenario with power factor increased by 15% in combination with a continued 10% cost decrease due to increased efficiency. The upper bound corresponds to a scenario where peak loads are increased by 15%, leading to reduced power factors and increased cost per MWh.
- F Price projections are based on an extrapolation of price development over the years 2000 - 2014 corrected for inflation. Over the six last years the prices have stabilized on a constant level and it is assumed that prices will remain stable. Lower uncertainty bounds for 2020 assumes a reduction of 10% of the costs due to

more efficient installations and a continued reduction by an additional 10% for 2050. No increases in costs are anticipated and upper bounds are set to today's level for both 2020 and 2050.

- G Costs for service lines are based on cables with a design voltage of 0,4 kV. For each power level the corresponding current was calculated using a power factor of 0,90. The current corresponds to different cable areas and costs. Two cables were chosen for each interval (one for the lowest power level and one for the highest level in the interval). The average of these two costs was used in the table. The service line length was based on the guidelines: 0-20 kW - 20 m, 20-100 kW - 50 m, Above 100 kW -100 m.
- H Costs for the single lines are based on cables with a design voltage of 12 kV. For each power level the corresponding current was calculated using a power factor of 0,90. The current corresponds to different cable areas and costs. Two cables were chosen for each interval (one for the lowest power level and one for the highest level in the interval). The average of these two costs was used in the table. Power levels below 250 kW and above 25 MW are not relevant for the specific voltage level. Above 6 MW more than one cable is needed. The cost of the material increases linear with the number of cables. The installation cost does not increase linear. An average cost based on the installation cost for one cable was used as a cost for more than one cable.
- I Reinforcement costs depends on whether it is the cables or stations that needs reinforcements. Reinforcement cost of cables is in parity with the investment cost for new single lines and depends on power level and cable length. Reinforcement of stations might be possible by replacing the current transformer with a new transformer with a higher power level. The cost for a new transformer, assuming the current station can still be used, is on average 11500 EUR/MW for a 800 kVA or 1250 kVA transformer.
- J The cost in EUR/MW of a 10/0.4 kV station depends on the desired power level of the station. A station with a low power level is more expensive per MW than a station with a high power level. In rural areas a lower power level is usually required. This results in a higher cost per MW for stations in rural areas. These assumptions were made: Rural areas: 1x315 kVA station. Suburban areas: 1x800 kVA station. City: 2x1250 kVA station. Costs for other requirements such as embedded/integrated stations are not included. Lower uncertainty bounds for 2020 assumes a reduction of 4,4% of the costs due to more efficient installations and a continued reduction by an additional 4,4% for 2050. No increases in costs are anticipated and upper bounds are set to today's level for both 2020 and 2050.
- K The percentage of the investment cost allocated to material cost and installation cost varies widely depending on cable area (power level). When the number of cables in each shaft increases the percentage of the material cost also increases. The average for one cable was used in the table. In more densely populated areas the installation costs increases due to expensive shafts. Lower uncertainty bounds for 2020 assumes a reduction of 17,6% of the investment costs due to more efficient installations and a continued reduction by an additional 10% for 2050.
- L The fixed O&M cost are calculated as a standard annual cost of 0,51% of the investment cost. It should be noted that the O&M cost in distribution system is mainly attributed to stations since there is practically no maintenance on cables. The O&M cost is assumed to be reduced due to increased efficiency by an annual factor of 1 - 1,8%. Lower uncertainty bounds for 2020 and 2050 corresponds to a continuous annual efficiency increase of 1,8% and upper bounds corresponds to no efficiency increase in O&M.
- M Variable O&M cost is in very low for electric transmission systems and considered to be negligible
- N Auxiliary electricity consumption can be considered negligible

References

- 1 Särskilda rapporten - teknisk data from Energimarknadsinspektionen (Statistics from Swedish utility companies) from 2014 (<http://www.ei.se/sv/Publikationer/Arsrapporter/>)
- 2 The Scope for Energy Saving in the EU through the Use of Energy-Efficient Electricity Distribution Transformers. H. De Keukebaer, D. Chapman, S. Fassbinder, M. McDermott, (2001).
- 3 International Electrotechnical Commission, Efficient Electrical Energy Transmission and Distribution (<http://www.iec.ch/about/brochures/pdf/technology/transmission.pdf>)
- 4 Energimarknadsinspektionens föreskrifter om intäktsramar för elnätsföretag.
http://ei.se/Documents/Publikationer/rapporter_och_pm/Rapporter%202015/Ei_R2015_01.pdf
- 5 Sweco, Project data
- 6 EBR cost database, developed by Swedish bransch organisation Svensk Energi.
- 7 Swedish Energy Markets Inspectorate (<http://ei.se/sv/el/Elnat-och-natprisreglering/de-olika-delarna-i-intaktsramen/>)

Table 3: Electricity distribution, Suburban

Technology	Electricity Distribution, Suburban									
	2015	2020	2030	2050	Uncertainty (2020)		Uncertainty (2050)		Note	Ref
Energy/technical data					Lower	Upper	Lower	Upper		
Energy losses, lines (%)	3	3	3	3	3	3	2,25	3	A	1
Energy losses, stations (%)	1,125	1,125	1,125	1,125	0,75	1,5	0,75	1,5	B	2
Auxiliary electricity consumption (% of energy delivered)	N/A	N/A	N/A	N/A	N/A	N/A	N/A	N/A	N	3
Technical life time (years)	40	40	40	40	35	40	35	50	C	4, 5
Typical load profile (-)	48%	48%	48%	48%	48%	48%	43%	55%	D	1, 5
- Residential	48%	48%	48%	48%	48%	48%	43%	55%	D	
- Commercial	48%	48%	48%	48%	48%	48%	43%	55%	D	
Construction time (years)	1	1	1	1	1	2	1	2		5
Financial data										
Distribution network costs (EUR/MWh/year) Suburban	385	385	385	385	347	385	312	487	E,F	1, 6
Investment costs; service line, 0 - 20 kW (EUR/unit)	1436	1436	1436	1436	1292	1436	1163	1436	G,F	6
Investment costs; service line, 20 - 50 kW (EUR/unit)	4031	4031	4031	4031	3628	4031	3265	4031	G,F	6
Investment costs; service line, 50-100 kW (EUR/unit)	4243	4243	4243	4243	3819	4243	3437	4243	G,F	6
Investment costs; service line, above 100 kW (EUR/unit)	9066	9066	9066	9066	8159	9066	7343	9066	G,F	6
Investment costs; single line, 0-50 kW (EUR/m)	N/A	N/A	N/A	N/A	N/A	N/A	N/A	N/A	H,F	
Investment costs; single line, 50-250 kW (EUR/m)	N/A	N/A	N/A	N/A	N/A	N/A	N/A	N/A	H,F	
Investment costs; single line, 100-250 kW (EUR/m)	N/A	N/A	N/A	N/A	N/A	N/A	N/A	N/A	H,F	6

111 Electricity distribution grid

Investment costs; single line, 250 kW - 1 MW (EUR/m)	75	75	75	75	65	75	59	75	H,F	6
Investment costs; single line, 1 MW - 5 MW (EUR/m)	80	80	80	80	70	80	63	80	H,F	6
Investment costs; single line, 5 MW - 25 MW (EUR/m)	128	128	128	128	118	128	106	128	H,F	6
Investment costs; single line, 25 MW - 100 MW (EUR/m)	N/A	N/A	N/A	N/A	N/A	N/A	N/A	N/A	H,F	
Reinforcement costs (EUR/MW) (Station)	11500	11500	11500	11500	10994	11500	10510	11500	I,F,J	6
Investment costs; [type 1] station (EUR/MW)	38000	38000	38000	38000	36328	38000	34730	38000	J	6
Investment costs; [type 2] station (EUR/MW)	N/A	N/A	N/A	N/A	N/A	N/A	N/A	N/A		
Investments, percentage installation (cables)	80%	80%	80%	80%	78%	80%	78%	80%	K	6
Investments, percentage materials (cables)	20%	20%	20%	20%	22%	20%	22%	20%	K	6
Investments, percentage installation (stations)	14%	14%	14%	14%	13%	14%	13%	14%	K	6
Investments, percentage materials (stations)	86%	86%	86%	86%	87%	86%	87%	86%	K	6
Fixed O&M (EUR/MW/year)	2681	2644	2607	2570	2633	2681	2539	2681	L	7
Variable O&M (EUR/MWh)	N/A	N/A	N/A	N/A	N/A	N/A	N/A	N/A	M	

Notes

- A The line losses were calculated using reference (1) and the formula Total energy exported to customer / Total energy fed into the system. Lines in rural areas have a higher loss than lines in more populated areas.
- B Losses in a transformer tend to decrease with increasing transformer capacity. The losses also depend on the transformer load. When the transformer load decreases under 20 % there is a large increase in the losses. In general the losses are about 1-2 %
- C According to the network price regulation from Energimarknadsinspektionen, the technical life time for stations and cables are 40 years. In practice, cable technical life can be shorter, depending on the thermal loading of the cable.
- D Calculations for the load profile were based on reference (1). This gave an average value of 44 % for all areas. The load profile is not expected to change to 2020. For 2050 the upper scenario is a smart grid scenario, in which the load factor remains the same, the lower scenario is an increase in peak load without the use of smart grid leading to a decrease in load factor by 26%.
- E The distributions network costs are based on the average station cost and cable cost per customer divided by the average yearly energy transported to a customer. Assumptions on the average cable length per customer and the average number of stations per customer could be translated to a total distribution network cost per customer using the EBR cost database. Cost per MWh are affected both by changes in actual costs and changes in load factors. In 2020 load factors are assumed to be constant. Lower bounds assumes a reduction of 10% of the costs due to more efficient installations, no cost increased is assumed. For 2050 the lower bounds corresponds to a smart grid scenario with power factor increased by 15% in combination with a continued 10% cost decrease due to increased efficiency. The upper bound corresponds to a scenario where peak loads are increased by 15%, leading to reduced power factors and increased cost per MWh.

- F Price projections are based on an extrapolation of price development over the years 2000 - 2014 corrected for inflation. Over the six last years the prices have stabilized on a constant level and it is assumed that prices will remain stable. Lower uncertainty bounds for 2020 assumes a reduction of 10% of the costs due to more efficient installations and a continued reduction by an additional 10% for 2050. No increases in costs are anticipated and upper bounds are set to today's level for both 2020 and 2050.
- G Costs for service lines are based on cables with a design voltage of 0,4 kV. For each power level the corresponding current was calculated using a power factor of 0,90. The current corresponds to different cable areas and costs. Two cables were chosen for each interval (one for the lowest power level and one for the highest level in the interval). The average of these two costs was used in the table. The service line length was based on the guidelines: 0-20 kW - 20 m, 20-100 kW - 50 m, Above 100 kW -100 m.
- H Costs for the single lines are based on cables with a design voltage of 12 kV. For each power level the corresponding current was calculated using a power factor of 0,90. The current corresponds to different cable areas and costs. Two cables were chosen for each interval (one for the lowest power level and one for the highest level in the interval). The average of these two costs was used in the table. Power levels below 250 kW and above 25 MW are not relevant for the specific voltage level. Above 6 MW more than one cable is needed. The cost of the material increases linear with the number of cables. The installation cost does not increase linear. An average cost based on the installation cost for one cable was used as a cost for more than one cable.
- I Reinforcement costs depends on whether it is the cables or stations that needs reinforcements. Reinforcement cost of cables is in parity with the investment cost for new single lines and depends on power level and cable length. Reinforcement of stations might be possible by replacing the current transformer with a new transformer with a higher power level. The cost for a new transformer, assuming the current station can still be used, is on average 11500 EUR/MW for a 800 kVA or 1250 kVA transformer.
- J The cost in EUR/MW of a 10/0.4 kV station depends on the desired power level of the station. A station with a low power level is more expensive per MW than a station with a high power level. In rural areas a lower power level is usually required. This results in a higher cost per MW for stations in rural areas. These assumptions were made: Rural areas: 1x315 kVA station. Suburban areas: 1x800 kVA station. City: 2x1250 kVA station. Costs for other requirements such as embedded/integrated stations are not included. Lower uncertainty is if Danish salaries decrease to the Swedish level (a decrease by 17,6 %). Upper level is if costs stay on today's level. For 2050 better efficiency is expected which is estimated to decrease the cost by an additional 10 %.
- K The percentage of the investment cost allocated to material cost and installation cost varies widely depending on cable area (power level). When the number of cables in each shaft increases the percentage of the material cost also increases. The average for one cable was used in the table. In more densely populated areas the installation costs increases due to expensive shafts. Lower uncertainty is if Danish salaries decrease to the Swedish level (a decrease by 17,6 %), this will decrease the installation costs.
- L The fixed O&M cost are calculated as a standard annual cost of 0,51% of the investment cost. It should be noted that the O&M cost in distribution system is mainly attributed to stations since there is practically no maintenance on cables. The O&M cost is assume to be reduced due to increased efficiency by an annual factor of 1 - 1,8%. Lower uncertainty bounds for 2020 and 2050 corresponds to a continuous annual efficiency increase of 1,8% and upper bounds corresponds to no efficiency increase in O&M.
- M Variable O&M cost is in very low for electric transmission systems and considered to be negligible

N Auxiliary electricity consumption can be considered negligible

References

- 1 Särskilda rapporten - teknisk data from Energimarknadsinspektionen (Statistics from Swedish utility companies) from 2014 (<http://www.ei.se/sv/Publikationer/Arssrapporter/>)
- 2 The Scope for Energy Saving in the EU through the Use of Energy-Efficient Electricity Distribution Transformers. H. De Keukebaer, D. Chapman, S. Fassbinder, M. McDermott, (2001).
- 3 International Electrotechnical Commission, Efficient Electrical Energy Transmission and Distribution (<http://www.iec.ch/about/brochures/pdf/technology/transmission.pdf>)
- 4 Energimarknadsinspektionens föreskrifter om intäktsramar för elnätsföretag.
http://ei.se/Documents/Publikationer/rapporter_och_pm/Rapporter%202015/Ei_R2015_01.pdf
- 5 Sweco, Project data
- 6 EBR cost database, developed by Swedish bransch organisation Svensk Energi.
- 7 Swedish Energy Markets Inspectorate (<http://ei.se/sv/el/Elnat-och-natprisreglering/de-olika-delarna-i-intaktsramen/>)

Table 4: Electricity distribution, city

Technology	Energy Transport Electricity Distribution, City									
	2015	2020	2030	2050	Uncertainty (2020)		Uncertainty (2050)		Note	Ref
Energy/technical data					Lower	Upper	Lower	Upper		
Energy losses, lines (%)	2,25	2,25	2,25	2,25	2,25	2,25	1,5	2,25	A	1
Energy losses, stations (%)	1,13	1,13	1,13	1,13	0,75	1,5	0,75	1,5	B	2
Auxiliary electricity consumption (% of energy delivered)	N/A	N/A	N/A	N/A	N/A	N/A	N/A	N/A	N	3
Technical life time (years)	40	40	40	40	35	40	35	50	C	4, 5
Typical load profile (-)	50%	50%	50%	50%	50%	50%	45%	58%	D	1, 5
- Residential	50%	50%	50%	50%	50%	50%	45%	58%	D	
- Commercial	50%	50%	50%	50%	50%	50%	45%	58%	D	
Construction time (years)	1	1	1	1	1	2	1	2		5
Financial data										
Distribution network costs (EUR/MWh/year) City	365	365	365	365	329	365	278	442	E,F	1, 6
Investment costs; service line, 0 - 20 kW (EUR/unit)	2149	2149	2149	2149	1934	2149	1741	2149	G,F	6
Investment costs; service line, 20 - 50 kW (EUR/unit)	5618	5618	5618	5618	5056	5618	4551	5618	G,F	6
Investment costs; service line, 50-100 kW (EUR/unit)	5774	5774	5774	5774	5197	5774	4677	5774	G,F	6
Investment costs; service line, above 100 kW (EUR/unit)	12131	12131	12131	12131	10918	12131	9826	12131	G,F	6
Investment costs; single line, 0-50 kW (EUR/m)	N/A	N/A	N/A	N/A	N/A	N/A	N/A	N/A	H,F	
Investment costs; single line, 50-250 kW (EUR/m)	N/A	N/A	N/A	N/A	N/A	N/A	N/A	N/A	H,F	
Investment costs; single line, 100-250 kW (EUR/m)	N/A	N/A	N/A	N/A	N/A	N/A	N/A	N/A	H,F	6
Investment costs; single line, 250 kW - 1 MW (EUR/m)	115	115	115	115	100	115	90	115	H,F	6

111 Electricity distribution grid

Investment costs; single line, 1 MW - 5 MW (EUR/m)	120	120	120	120	104	120	94	120	H,F	6
Investment costs; single line, 5 MW - 25 MW (EUR/m)	169	169	169	169	154	169	139	169	H,F	6
Investment costs; single line, 25 MW - 100 MW (EUR/m)	N/A	N/A	N/A	N/A	N/A	N/A	N/A	N/A	H,F	
Reinforcement costs (EUR/MW) (Station)	11500	11500	11500	11500	10994	11500	10510	11500	I,F,J	6
Investment costs; [type 1] station (EUR/MW)	38000	38000	38000	38000	36328	38000	34730	38000	J	6
Investment costs; [type 2] station (EUR/MW)	N/A	N/A	N/A	N/A	N/A	N/A	N/A	N/A		
Investments, percentage installation (cables)	86%	86%	86%	86%	N/A	N/A	N/A	N/A	K	6
Investments, percentage materials (cables)	14%	14%	14%	14%	N/A	N/A	N/A	N/A	K	6
Investments, percentage installation (stations)	5%	5%	5%	5%	4%	5%	4%	5%	K	6
Investments, percentage materials (stations)	95%	95%	95%	95%	96%	95%	96%	95%	K	6
Fixed O&M (EUR/MW/year)	2866	2826	2786	2747	2814	2866	2714	2866	L	7
Variable O&M (EUR/MWh)	N/A	N/A	N/A	N/A	N/A	N/A	N/A	N/A	M	

Notes

- A The line losses were calculated using reference (1) and the formula $\text{Total energy exported to customer} / \text{Total energy fed into the system}$. Lines in rural areas have a higher loss than lines in more populated areas.
- B Losses in a transformer tend to decrease with increasing transformer capacity. The losses also depend on the transformer load. When the transformer load decreases under 20 % there is a large increase in the losses. In general the losses are about 1-2 %
- C According to the network price regulation from Energimarknadsinspektionen, the technical life time for stations and cables are 40 years. In practice, cable technical life can be shorter, depending on the thermal loading of the cable.
- D Calculations for the load profile were based on reference (1). This gave an average value of 44 % for all areas. The load profile is not expected to change to 2020. For 2050 the upper scenario is a smart grid scenario, in which the load factor is increased by 6 %, the lower scenario is an increase in peak load without the use of smart grid leading to a decrease in load factor by 21%.
- E The distributions network costs are based on the average station cost and cable cost per customer divided by the average yearly energy transported to a customer. Assumptions on the average cable length per customer and the average number of stations per customer could be translated to a total distribution network cost per customer using the EBR cost database. Cost per MWh are affected both by changes in actual costs and changes in load factors. In 2020 load factors are assumed to be constant. Lower bounds assume a reduction of 10% of the costs due to more efficient installations, no cost increased is assumed. For 2050 the lower bounds corresponds to a smart grid scenario with power factor increased by 15% in combination with a continued 10% cost decrease due to increased efficiency. The upper bound corresponds to a scenario where peak loads are increased by 15%, leading to reduced power factors and increased cost per MWh.
- F Price projections are based on an extrapolation of price development over the years 2000 - 2014 corrected for inflation. Over the six last years the prices have stabilized on a constant level and it is assumed that prices will remain stable. Lower uncertainty bounds for 2020 assumes a reduction of 10% of the costs due to

more efficient installations and a continued reduction by an additional 10% for 2050. No increases in costs are anticipated and upper bounds are set to today's level for both 2020 and 2050.

- G Costs for service lines are based on cables with a design voltage of 0,4 kV. For each power level the corresponding current was calculated using a power factor of 0,90. The current corresponds to different cable areas and costs. Two cables were chosen for each interval (one for the lowest power level and one for the highest level in the interval). The average of these two costs was used in the table. The service line length was based on the guidelines: 0-20 kW - 20 m, 20-100 kW - 50 m, Above 100 kW -100 m.
- H Costs for the single lines are based on cables with a design voltage of 12 kV. For each power level the corresponding current was calculated using a power factor of 0,90. The current corresponds to different cable areas and costs. Two cables were chosen for each interval (one for the lowest power level and one for the highest level in the interval). The average of these two costs was used in the table. Power levels below 250 kW and above 25 MW are not relevant for the specific voltage level. Above 6 MW more than one cable is needed. The cost of the material increases linear with the number of cables. The installation cost does not increase linear. An average cost based on the installation cost for one cable was used as a cost for more than one cable.
- I Reinforcement costs depends on whether it is the cables or stations that needs reinforcements. Reinforcement cost of cables is in parity with the investment cost for new single lines and depends on power level and cable length. Reinforcement of stations might be possible by replacing the current transformer with a new transformer with a higher power level. The cost for a new transformer, assuming the current station can still be used, is on average 11500 EUR/MW for a 800 kVA or 1250 kVA transformer.
- J The cost in EUR/MW of a 10/0.4 kV station depends on the desired power level of the station. A station with a low power level is more expensive per MW than a station with a high power level. In rural areas a lower power level is usually required. This results in a higher cost per MW for stations in rural areas. These assumptions were made: Rural areas: 1x315 kVA station. Suburban areas: 1x800 kVA station. City: 2x1250 kVA station. Costs for other requirements such as embedded/integrated stations are not included. Lower uncertainty is if Danish salaries decrease to the Swedish level (a decrease by 17,6 %). Upper level is if costs stay on today's level. For 2050 better efficiency is expected which is estimated to decrease the cost by an additional 10 %.
- K The percentage of the investment cost allocated to material cost and installation cost varies widely depending on cable area (power level). When the number of cables in each shaft increases the percentage of the material cost also increases. The average for one cable was used in the table. In more densely populated areas the installation costs increases due to expensive shafts. Lower uncertainty is if Danish salaries decrease to the Swedish level (a decrease by 17,6 %), this will decrease the installation costs.
- L The fixed O&M cost are calculated as a standard annual cost of 0,51% of the investment cost. It should be noted that the O&M cost in distribution system is mainly attributed to stations since there is practically no maintenance on cables. The O&M cost is assumed to be reduced due to increased efficiency by an annual factor of 1 - 1,8%. Lower uncertainty bounds for 2020 and 2050 corresponds to a continuous annual efficiency increase of 1,8% and upper bounds corresponds to no efficiency increase in O&M.
- M Variable O&M cost is in very low for electric transmission systems and considered to be negligible
- N Auxiliary electricity consumption can be considered negligible

References

- 1 Särskilda rapporten - teknisk data from Energimarknadsinspektionen (Statistics from Swedish utility companies) from 2014 (<http://www.ei.se/sv/Publikationer/Arsrapporter/>)
- 2 The Scope for Energy Saving in the EU through the Use of Energy-Efficient Electricity Distribution Transformers. H. De Keukebaer, D. Chapman, S. Fassbinder, M. McDermott, (2001).
- 3 International Electrotechnical Commission, Efficient Electrical Energy Transmission and Distribution (<http://www.iec.ch/about/brochures/pdf/technology/transmission.pdf>)
- 4 Energimarknadsinspektionens föreskrifter om intäktsramar för elnätsföretag.
http://ei.se/Documents/Publikationer/rapporter_och_pm/Rapporter%202015/Ei_R2015_01.pdf
- 5 Sweco, Project data
- 6 EBR cost database, developed by Swedish bransch organisation Svensk Energi.
- 7 Swedish Energy Markets Inspectorate (<http://ei.se/sv/el/Elnat-och-natprisreglering/de-olika-delarna-i-intaktsramen/>)

Table 5: Electricity distribution, New developed area

Technology	Electricity Distribution, New developed areas									
	2015	2020	2030	2050	Uncertainty (2020)		Uncertainty (2050)		Note	Ref
Energy/technical data					Lower	Upper	Lower	Upper		
Energy losses, lines (%)	3	3	3	3	2,25	3	2,25	3	A	1
Energy losses, stations (%)	1,1	1,1	1,1	1,1	0,75	1,5	0,75	1,5	B	2
Auxiliary electricity consumption (% of energy delivered)	N/A	N/A	N/A	N/A	N/A	N/A	N/A	N/A	N	3
Technical life time (years)	40	40	40	40	35	40	35	50	C	4, 5
Typical load profile (-)	48%	48%	48%	48%	48%	48%	43%	55%	D	1, 5
- Residential	48%	48%	48%	48%	48%	48%	43%	55%	D	
- Commercial	48%	48%	48%	48%	48%	48%	43%	55%	D	
Construction time (years)	1	1	1	1	1	2	1	2		5
Financial data										
Distribution network costs (EUR/MWh/year) New developed area	173	173	173	173	156	173	132	206	E,F	1, 6
Investment costs; service line, 0 - 20 kW (EUR/unit)	524	524	524	524	472	524	424	524	G,F	6
Investment costs; service line, 20 - 50 kW (EUR/unit)	1412	1412	1412	1412	1271	1412	1144	1412	G,F	6
Investment costs; service line, 50-100 kW (EUR/unit)	1583	1583	1583	1583	1425	1583	1282	1583	G,F	6
Investment costs; service line, above 100 kW (EUR/unit)	3745	3745	3745	3745	3371	3745	3033	3745	G,F	6
Investment costs; single line, 0-50 kW (EUR/m)	N/A	N/A	N/A	N/A	N/A	N/A	N/A	N/A	H,F	
Investment costs; single line, 50-250 kW (EUR/m)	N/A	N/A	N/A	N/A	N/A	N/A	N/A	N/A	H,F	
Investment costs; single line, 100-250 kW (EUR/m)	36	36	36	36	32	36	29	36	H,F	6
Investment costs; single line, 250 kW - 1 MW (EUR/m)	36	36	36	36	32	36	29	36	H,F	6
Investment costs; single line, 1 MW - 5 MW (EUR/m)	41	41	41	41	37	41	33	41	H,F	6
Investment costs; single line, 5 MW - 25 MW (EUR/m)	88	88	88	88	85	88	77	88	H,F	6
Investment costs; single line, 25 MW - 100 MW (EUR/m)	N/A	N/A	N/A	N/A	N/A	N/A	N/A	N/A	H,F	
Reinforcement costs (EUR/MW) (Station)	11500	11500	11500	11500	10994	11500	10510	11500	I,F,J	6
Investment costs; [type 1] station (EUR/MW)	38000	38000	38000	38000	36328	38000	34730	38000	J	6
Investment costs; [type 2] station (EUR/MW)	N/A	N/A	N/A	N/A	N/A	N/A	N/A	N/A		
Investments, percentage installation (cables)	80%	80%	80%	80%	78%	80%	78%	80%	K	6
Investments, percentage materials (cables)	20%	20%	20%	20%	22%	20%	22%	20%	K	6
Investments, percentage installation (stations)	14%	14%	14%	14%	13%	14%	13%	14%	K	6
Investments, percentage materials (stations)	86%	86%	86%	86%	87%	86%	87%	86%	K	6
Fixed O&M (EUR/MW/year)	1358	1339	1321	1302	1334	1358	1286	1358	L	7
Variable O&M (EUR/MWh)	N/A	N/A	N/A	N/A	N/A	N/A	N/A	N/A	M	

Notes

- A The line losses were calculated using reference (1) and the formula $\text{Total energy exported to customer} / \text{Total energy fed into the system}$. Lines in rural areas have a higher loss than lines in more populated areas.
- B Losses in a transformer tend to decrease with increasing transformer capacity. The losses also depend on the transformer load. When the transformer load decreases under 20 % there is a large increase in the losses. In general the losses are about 1-2 %
- C According to the network price regulation from Energimarknadsinspektionen, the technical life time for stations and cables are 40 years. In practice, cable technical life can be shorter, depending on the thermal loading of the cable.
- D Calculations for the load profile were based on reference (1). This gave an average value of 48 % for all areas. The load profile is not expected to change to 2020. For 2050 the upper scenario is a smart grid scenario, in which the load factor increases by 10 %, the lower scenario is an increase in peak load of 15 % without the use of smart grid leading to a corresponding decrease in load factor.
- E The distribution network costs are based on the average station cost and cable cost per customer divided by the average yearly energy transported to a customer. Assumptions on the average cable length per customer and the average number of stations per customer could be translated to a total distribution network cost per customer using the EBR cost database. Costs per MWh are affected both by changes in actual costs and changes in load factors. In 2020 load factors are assumed to be constant. Lower bounds assume a reduction of 10% of the costs due to more efficient installations, no cost increase is assumed. For 2050 the lower bounds corresponds to a smart grid scenario with power factor increased by 15% in combination with a continued 10% cost decrease due to increased efficiency. The upper bound corresponds to a scenario where peak loads are increased by 15%, leading to reduced power factors and increased cost per MWh.
- F Price projections are based on an extrapolation of price development over the years 2000 - 2014 corrected for inflation. Over the six last years the prices have stabilized on a constant level and it is assumed that prices will remain stable. Lower uncertainty bounds for 2020 assumes a reduction of 10% of the costs due to more efficient installations and a continued reduction by an additional 10% for 2050. No increases in costs are anticipated and upper bounds are set to today's level for both 2020 and 2050.
- G Costs for service lines are based on cables with a design voltage of 0,4 kV. For each power level the corresponding current was calculated using a power factor of 0,90. The current corresponds to different cable areas and costs. Two cables were chosen for each interval (one for the lowest power level and one for the highest level in the interval). The average of these two costs was used in the table. The service line length was based on the guidelines: 0-20 kW - 20 m, 20-100 kW - 50 m, Above 100 kW -100 m.
- H Costs for the single lines are based on cables with a design voltage of 12 kV. For each power level the corresponding current was calculated using a power factor of 0,90. The current corresponds to different cable areas and costs. Two cables were chosen for each interval (one for the lowest power level and one for the highest level in the interval). The average of these two costs was used in the table. Power levels below 250 kW and above 25 MW are not relevant for the specific voltage level. Above 6 MW more than one cable is needed. The cost of the material increases linear with the number of cables. The installation cost does not increase linear. An average cost based on the installation cost for one cable was used as a cost for more than one cable.
- I Reinforcement costs depends on whether it is the cables or stations that needs reinforcements. Reinforcement cost of cables is in parity with the investment cost for new single lines and depends on power level and cable length. Reinforcement of stations might be possible by replacing the current transformer with a new transformer

with a higher power level. The cost for a new transformer, assuming the current station can still be used, is on average 11500 EUR/MW for a 800 kVA or 1250 kVA transformer.

J The cost in EUR/MW of a 10/0.4 kV station depends on the desired power level of the station. A station with a low power level is more expensive per MW than a station with a high power level. In rural areas a lower power level is usually required. This results in a higher cost per MW for stations in rural areas. These assumptions were made: Rural areas: 1x315 kVA station. Suburban areas: 1x800 kVA station. City: 2x1250 kVA station. Costs for other requirements such as embedded/integrated stations are not included. Lower uncertainty is if Danish salaries decrease to the Swedish level (a decrease by 17,6 %). Upper level is if costs stay on today's level. For 2050 better efficiency is expected which is estimated to decrease the cost by an additional 10 %.

K The percentage of the investment cost allocated to material cost and installation cost varies widely depending on cable area (power level). When the number of cables in each shaft increases the percentage of the material cost also increases. The average for one cable was used in the table. In more densely populated areas the installation costs increase due to expensive shafts. Lower uncertainty is if Danish salaries decrease to the Swedish level (a decrease by 17,6 %), this will decrease the installation costs.

L The fixed O&M cost are calculated as a standard annual cost of 0,51% of the investment cost. It should be noted that the O&M cost in distribution system is mainly attributed to stations since there is practically no maintenance on cables. The O&M cost is assumed to be reduced due to increased efficiency by an annual factor of 1 - 1,8%. Lower uncertainty bounds for 2020 and 2050 corresponds to a continuous annual efficiency increase of 1,8% and upper bounds corresponds to no efficiency increase in O&M.

M Variable O&M cost is very low for electric transmission systems and considered to be negligible

N Auxiliary electricity consumption can be considered negligible

References

- 1 Särskilda rapporten - teknisk data from Energimarknadsinspektionen (Statistics from Swedish utility companies) from 2014 (<http://www.ei.se/sv/Publikationer/Arsrapporter/>)
- 2 The Scope for Energy Saving in the EU through the Use of Energy-Efficient Electricity Distribution Transformers. H. De Keukebaer, D. Chapman, S. Fassbinder, M. McDermott, (2001).
- 3 International Electrotechnical Commission, Efficient Electrical Energy Transmission and Distribution (<http://www.iec.ch/about/brochures/pdf/technology/transmission.pdf>)
- 4 Energimarknadsinspektionens föreskrifter om intäktsramar för elnätsföretag.
http://ei.se/Documents/Publikationer/rapporter_och_pm/Rapporter%202015/Ei_R2015_01.pdf
- 5 Sweco, Project data
- 6 EBR cost database, developed by Swedish branch organisation Svensk Energi.
- 7 Swedish Energy Markets Inspectorate (<http://ei.se/sv/el/Elnat-och-natprisreglering/de-olika-delarna-i-intaktsramen/>)

112 Natural gas distribution grid

Contact information:

Danish Energy Agency: Rikke Næraa, rin@ens.dk

Energinet: Rune Duban Grandal, rdg@energinet.dk

Author: Henrik Iskov, his@dgc.dk

Reviewer: Torben Kvist, tkv@dgc.dk

Qualitative description

Brief technology description

General information on the natural gas network

The natural gas system in Denmark is divided into different levels. These are:

- Transmission at 80 bar
- Main distribution at 16-40 bar
- Distribution

An overview of the transmission and distribution lines is shown in Figure 1.

The transmission network will not be covered extensively, as it is beyond the scope of this section. For safety reasons an odorant is added to gas before it enters the main distribution system, see Figure 1. The odorant gives the gas its characteristic smell of gas.

Figure 2 shows that the gas network covers most of Denmark, except for some of the islands and a part around Aarhus and Djursland.

Besides the natural gas network, there are networks for town gas in Copenhagen and Aalborg. However, the town gas networks will not be covered, as they use a different gas pressure, convey town gas (today a mixture of natural gas and air) and are constructed in a different period of time as well as with a different technology.

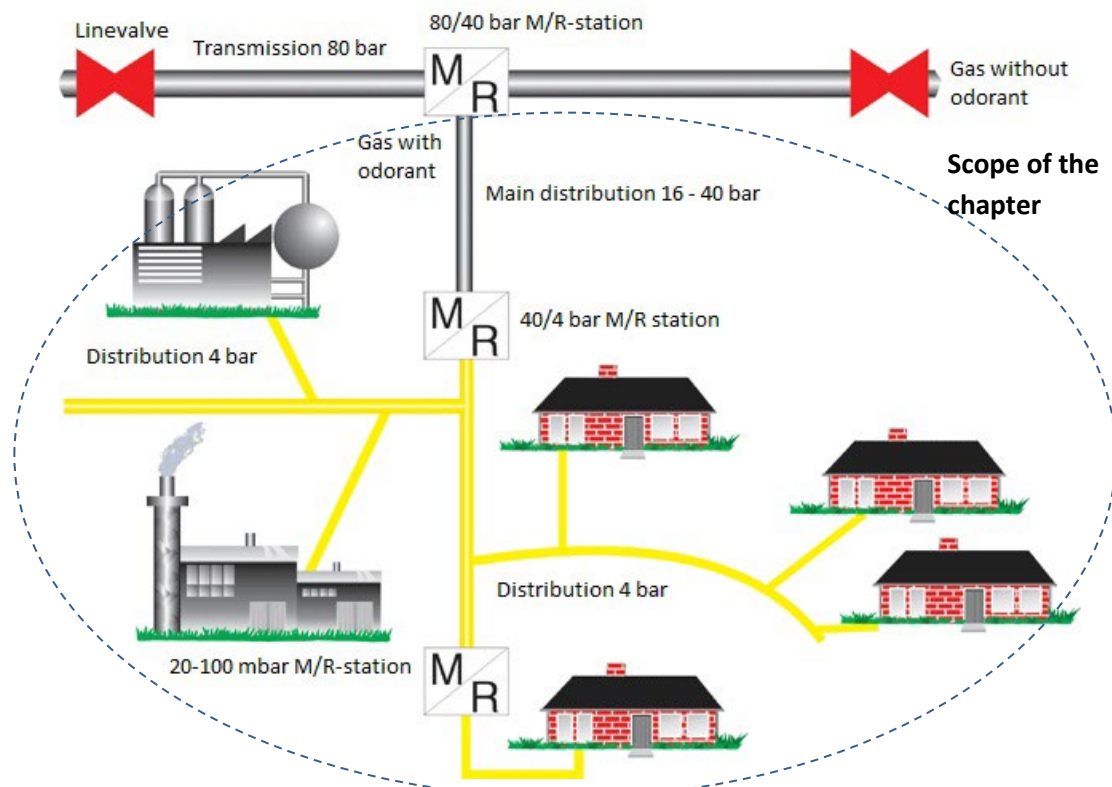

Figure 1 Overview of the gas network. Based on ref. [1].

Ownership of the network

Energinet, the Danish national transmission system operator for the natural gas system, owns and operates the transmission system. The distribution network, including main distribution lines, are owned and operated by the distribution companies.

When the natural gas network was planned, the network was divided into five areas:

- Northern part of Jutland
- Southern part of Jutland
- Funen
- Western part of Zealand
- Northern part of Zealand

However, some gas distribution companies have merged so that today there are currently three natural gas distribution companies:

- Dansk Gas Distribution A/S (Previously DONG Gas Distribution A/S)
- NGF Nature Energy Distribution A/S
- HMN Gasnet P/S

Their coverage can be seen in Figure 2, where the original division in five areas also can be perceived.

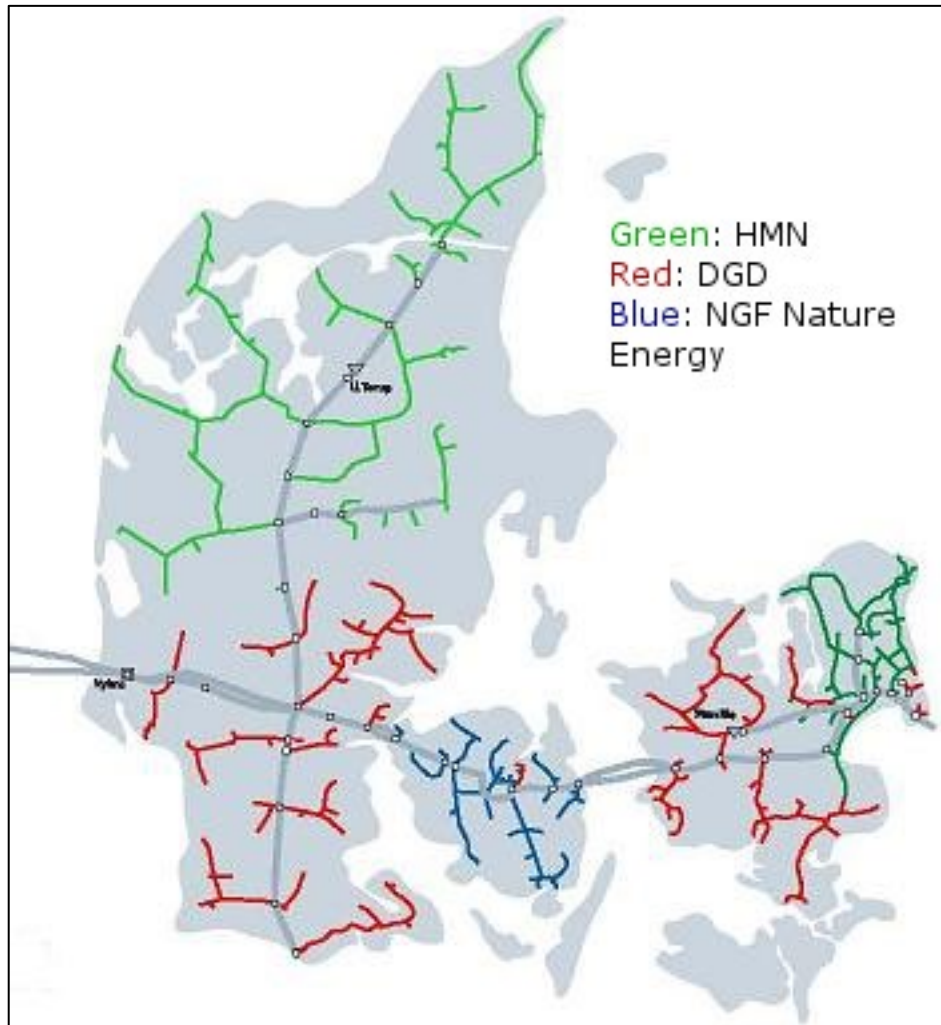

Figure 2 Geographical extent of the Danish transmission network (grey) and the main distribution network (green, red & blue). The colours refer to the companies operating the system.

Due to the described history of ownership, different designs and pressure levels exist in different parts of Denmark. The natural gas system contains pipelines operating at different pressure levels. The highest pressure is found in the gas transmission grid that operates at pressures of up to 80 bars. The maximum pressure in the main distribution grid varies among the gas distribution companies and regions (cf. Figure 2):

- HMN Jutland: 40 bar
- HMN Zealand: 19 or 40 bar
- DGD Jutland: 40 bar
- DGD Zealand: 19 bar
- NGF Nature Energy: 19 bar

Input

As of 2016, the main source of natural gas in Denmark is the North Sea where the natural gas is produced, mainly from the Tyra field. The natural gas is then transported from the North Sea to the onshore transmission network.

Besides the source in the North Sea, natural gas can also be imported from Germany. This part of the transmission line to Germany can be used both for import and for export.

The transmission network has five entry/exit points for natural gas:

- Nybro at the west coast of Jutland is the main entry point for Danish gas from North Sea gas fields.
- Ellund at the border to Germany is both an entry point for gas import and an exit point for gas export.
- Dragør near Copenhagen is the exit point for the gas export to Sweden.
- Stenlille on Zealand is one of the two Danish entry/exit points to a seasonal underground gas storage facility.
- Lille Torup in northern Jutland is another entry/exit point to a seasonal underground gas storage facility.

Since 2011, biogas upgraded to gas network quality has been injected into the gas network. From the start only at gas distribution level, but from 2016, biogas has been injected into the gas transmission network.

Output

The output is the same as the input, namely gas. As losses from the gas system are negligible, the amount of gas delivered from the gas network is basically the same as the amount delivered to it.

Energy balance

The energy consumption related to operation of the gas network is generally low. The network is supplied with natural gas at a sufficiently high pressure, so no further compression is required in the main distribution lines or in the distribution system. Therefore, the electric power consumption related to operation of the main distribution lines and the distribution system is as low as 0.005 % of the transported energy.

Reduction of the pressure in the system necessitates preheating, as the gas is cooled by the expansion. The heat is provided by burning an amount of gas corresponding to around 0.1 % of expanded gas. However, as there are different pressure levels in different parts of the country, preheating is not always required.

Description of the main distribution system

The main distribution system is supplied with gas from the transmission system. As mentioned earlier, the pressure in the transmission system is 80 bar. Before entering the main distribution system of the transmission system, the pressure is reduced to 19 or 40 bar depending on the geographical location. The pressure reduction takes place in MR (meter/regulator) stations.

- HMN Jutland: MR stations regulate pressure from 40 to 4 bar.
- HMN Zealand: MR stations regulate from both 40 and 19 bar down to 4 bar.
- DGD Jutland: MR stations regulate pressure from 40 to 4 bar.
- DGD Zealand: MR stations regulate pressure from 19 to 4 bar.
- NGF Nature Energy: MR stations regulate pressure from 19 to 4 bar.

As mentioned earlier, operation of MR stations with pressure reduction from 40 to 4 bar requires preheating, as the gas is cooled by the expansion. The heat is provided by burning an amount of gas corresponding to around 0.1 % of expanded gas. For MR stations with the more limited pressure reduction from 19 to 4 bar, preheating is not required. Instead, further preheating is required when the gas is expanded from 80 to 19 bar, compared to expanding from 80 to 40 bar.

The main distribution system supplies the 4 bar distribution network as well as a limited number of larger consumers, such as CHP plants and industrial customers. Due to the high pressure, the system is made of steel pipes.



Figure 3 Routing of gasline with distribution pipe. Source: HMN Gasnet.

Description of distribution system

Gas from the transmission system supplies the distribution system with gas at 4 bar. Before the gas enters gas installations, the pressure is reduced from 4 bar to 20 mbar, and the gas consumption is measured.



Figure 4 Cupboard containing pressure regulator and flowmeter mounted outside a private house.

In some areas, mainly the Greater Copenhagen area and the southern part of Jutland, Distribution Regulator stations (DR) reduce the gas pressure from 4 bar to 100 mbar before the gas is delivered to customers. However, all three gas distribution companies have stated that this will not be done for future networks, except for rare special cases [3][4][5]. Therefore, 100 mbar systems will not be treated further in this description.

Space requirement

The space requirement for the described system is limited to the MR stations. The space requirement for a 40/4 bar or 19/4 bar MR station is around 1,000 m².

Advantages/disadvantages

The gas system has a number of advantages.

It can be supplied with gases from various sources, including green gases, such as upgraded biogas and gases from power-to-gas processes, as long as the gas meets the natural gas specifications. It provides a large storage capacity corresponding to 2-3 months of consumption [1]. These properties may allow integration of large amounts of renewable energy in the energy system.

Furthermore, the gas system can provide very high power capacity compared to most other energy carriers, which is required by some parts of the industry [7]. The energy loss is very low compared to other energy distribution and transport systems.

The main disadvantage is that today the cost of producing green gases of natural gas quality from e.g. renewable power production is relatively high. Therefore, the only green gas in the Danish gas system is upgraded biogas.

Environment

Natural gas networks have a minimal environmental impact during the construction phase.

The environmental impacts during operation mainly consist of CO₂ emissions due to preheating at MR stations and minor losses of mainly methane during distribution of the gas.

There are no general data available on methane loss from the Danish gas system. If data from a European survey are applicable for the Danish system, the losses will correspond to 0.1 % of the amount of gas transported in gas networks. European gas networks are generally older than the Danish system. Therefore, it is expected that the losses from the Danish system are lower than the 0.1 %.

Research and development perspectives

Transportation and distribution of natural gas is a proven and efficient technology. Only little development is expected. The main development is expected to be in relation to green gas production and utilization of the gas.

Examples of market standard technology

The transmission lines and main distribution lines are made of steel pipes, whereas the 4 bar distribution system is made of PE pipes.

MR stations mostly consist of a redundant string with pressure regulators, meters (volume flow measurements) as well as pressure and temperature measurement and flow computer in order to determine gas flow at reference conditions.

If a distribution line is crossing a stream, a road or a railway directional drilling is often applied, which has made such crossings significantly cheaper than it was earlier.

Prediction of performance and costs

Prediction of cost and energy consumption is mainly based on the experience of HMN Gasnet.

Natural gas networks represent a mature and commercial technology with large deployment, corresponding to technological maturity level category 4. Therefore, prices have more or less stabilized over the last years. No significant changes in performance and costs are expected to happen to the technology in the foreseeable future.

Uncertainty

Data on construction costs for gas networks depend on a number of project specific details and are difficult to generalize.

Furthermore, if developments in e.g. directional drilling occur, they will impact costs in a way that is difficult to anticipate.

Additional remarks

The biogas' path to the Danish gas network

As mentioned earlier, today biogas is injected into the existing natural gas infrastructure. Costs related to biogas are not included in data stated in the data section.

What is biogas?

Biogas is produced by anaerobic digestion of biodegradable material. It consists mainly of 50-80 % methane and 20-50 % CO₂. In addition, biogas contains low concentrations of undesirable substances, e.g. impurities, such as H₂S, siloxanes, ammonia, oxygen and volatile organic carbons (VOC).

Biogas quality requirements

In order to be injected into the natural gas network or in order to be used in gas vehicles, the upgraded biogas quality must meet the same requirements as natural gas. In Denmark, these requirements are described in the Gas Regulations, section C12. The methane limit is not directly specified in C12, but can be deduced from the lower wobbe limit, which is 50.8 MJ/Nm³. This equals a minimum methane content of 97.3 % assuming the rest is CO₂.

H₂S is limited to 5 mg/Nm³. To avoid the risk of condensation, the water dew point up to 70 bar must be below minus 8 °C. Further requirements are given in the Gas Regulations, section C12.

Biogas upgrading

A large number of technologies are available for upgrading, but four technologies stand out as the clearly most common technologies

- Water scrubber
- Chemical scrubber (amine scrubber)
- Membrane scrubber
- PSA (Pressure Swing Absorption) scrubber

The technologies are further described in [8].

Biogas odourisation

Biogas must be odorized before entering a gas distribution network. The level of odourisation is the same as for natural gas, see C12. No odourisation is done, if the upgraded biogas is injected into the transmission system.

Injection points

Possible injection points

- Nearby 4 bar distribution network.
- Nearby 19-40 bar distribution network. Gas compression is needed before injection.
- Nearby 80 bar gas transmission network. Gas compression is needed before injection.

The selection of injection point(s) depends on

- Biogas plant capacity

- Local 4 bar gas distribution network base-load consumption
- Distance to nearby 4 bar gas distribution network
- Distance to nearby 19-40 bar gas distribution network
- Local 4 bar gas distribution network base-load consumption
- Distance to nearby 80 bar gas transmission network
- Cost of compression.

If the local gas consumption shows large variations during the day, a local intermediate storage facility can be used to increase the local consumption of biogas/upgraded biogas.

Selection of entry point(s) will be based on an economic optimization.

References

- [1] www.naturgasfakta.dk
- [2] www.gasmarked.dk
- [3] Dansk Gas Distribution
- [4] NGF Nature Energy
- [5] HMN Gasnet
- [6] Energinet
- [7] DGC
- [8] "Biogas upgrading - Technology review", published by Energiforsk 2016. ISBN 978-91-7673-275-5.

Data sheets

Table 6: Natural gas main distribution line

Technology	Energy Transport, Natural Gas Main distribution line									
	2015	2020	2030	2050	Uncertainty (2020)		Uncertainty (2050)		Note	Ref
Energy/technical data					Lower	Upper	Lower	Upper		
Energy losses, lines 1-20 MW (%)	0,1	0,1	0,1	0,1	0,01	0,15	0,01	0,15	A	1
Energy losses, lines 20-100 MW (%)	0,1	0,1	0,1	0,1	0,01	0,15	0,01	0,15	A	
Energy losses, lines above 100 MW (%)	0,1	0,1	0,1	0,1	0,01	0,15	0,01	0,15	A	
Energy losses, stations [Type 1] (%)	-	-	-	-	-	-	-	-	B	
Energy losses, stations [Type 2] (%)	0,10	0,10	0,10	0,10	0	0,12	0	0,12	C	2
Auxiliary electricity consumption (% energy transmitted)	0,005	0,005	0,005	0,005	0,004	0,006	0,004	0,006		2
Technical life time (years)	50	50	50	50	50	80	50	80		2
Typical load profile (-)	0,2	0,2	0,2	0,2	0,05	0,4	0,05	0,4		2
Construction time (years)	1	1	1	1	0,7	1,5	0,7	1,5	D	2
Financial data										
Investment costs										
Investment costs; single line, 0 - 50 MW (EUR/MW/m)	11	11	11	11	9	13	9	13	E, F	2
Investment costs; single line, 50-100 MW (EUR/MW/m)	4,2	4	4	4	3,4	5,0	3,4	5,0	E, G	2
Investment costs; single line, 100 - 250 MW (EUR/MW/m)	2,2	2	2	2	1,8	2,7	1,8	2,7	E, G	2
Investment costs; single line, 250-500 MW (EUR/MW/m)	1,2	1	1	1	0,9	1,4	0,9	1,4	E, G	2
Investment costs; single line, 500-1000 MW (EUR/MW/m)	0,7	1	1	1	0,5	0,8	0,5	0,8	E, G	1
Investment costs; single line, above 1000 MW (EUR/MW/m)	-	-	-	-	-	-	-	-	i	
Reinforcement costs (EUR/MW)	-	-	-	-	-	-	-	-	H	
Investment costs; [type 1] station (EUR/MW)	-	-	-	-	-	-	-	-	B, J	
Investment costs; [type 2] station (EUR/MW)	27000	27000	27000	27000	7000	45000	0	0	C, K	2
Investments, percentage installation	75	75	75	75	65	85	65	85		2
Investments, percentage materials	25	25	25	25	15	35	15	35		2
Fixed O&M (EUR/MW/km/year)	0,12	0,12	0,12	0,12	0,10	0,15	0,10	0,15		2
Variable O&M (EUR/MWh/km)	1,1E-05	1,1E-05	1,1E-05	1,1E-05	9,0E-06	1,4E-05	9,0E-06	1,4E-05		2

Notes

- A There are no general data available for the Danish gas system. The stated losses are based on a European survey that includes all parts in level 2 of the transmission, including stations. It is assumed that the losses (given as kg/km) are the same for transmission level 1 and 2. European gas networks are generally older than the Danish system. Therefore, it is expected that the losses from the Danish system are significantly lower than stated in the table. The lack of data explains the high uncertainty stated.
- B Type 1 MR stations supplying the transmission system level 2 - not part of the scope
- C Type 2 MR stations supplying the 4 bar distribution system. The stated number represents the gas consumption for preheating before expansion from 40 to 4 bar. Expansion from 19 or 16 bar to 4 bar doesn't require preheating. Losses are included in the number stated for lines, see note A.
- D Includes engineering, tender, and construction.
- E Rates include VVM review, landowner compensation and archaeological screening. Based on 20 km, of which 8 % is based on drilling.
- F Data given is for a 50 MW capacity
- G Two pipes were chosen for each interval (one for the lowest power level and one for the highest). The average of these two are stated in the table.
- H Not possible to give general numbers. Depends on kind of reinforcement. Can be calculated based on the other numbers given.
- I Capacity not relevant - too high
- J Type 1 MR stations supplying the transmission system level 2 - not part of the scope
- K Type 1 MR stations supplying the transmission system level 2 .The stated costs are the average cost for a 40/4 bar MR station where reheating after expansion is required and a 19/4 bar MR station where reheating is not necessary. The cost is only modestly size dependent. A 40/4 bar station capacity of 10.000 m³/h is 20 % higher than a similar station with a capacity of 5.000 m³/h.

References

- 1 Survey methane emissions for gas transmission and distribution in Europe Marcogaz WG-ME-14-26
29/02/2016
- 2 HMN Naturgas

Table 7: Gas Distribution, rural

Technology	Natural Gas Distribution, rural areas									
	2015	2020	2030	2050	Uncertainty (2020)		Uncertainty (2050)		Note	Ref
Energy/technical data					Lower	Upper	Lower	Upper		
Energy losses, lines (%)	0,26	0,26	0,26	0,26	0,05	0,3	0,05	0,3	A	1
Energy losses, stations (%)	-	-	-	-	-	-	-	-	B	
Auxiliary electricity consumption (% of energy delivered)	0	0	0	0	0	0	0	0	C	
Technical life time (years)	50	50	50	50	50	80	50	80		2
Typical load profile (-)									D	
- Residential	0,2	0,2	0,2	0,2	0,15	0,25	0,15	0,25	D	
- Commercial	N/A	N/A	N/A	N/A					D	
Construction time (years)	0,4	0,4	0,4	0,4	0,3	0,5	0,3	0,5		2
Financial data										
Distribution network costs (EUR/MWh/year) Rural	140	140	140	140	130	150	130	150		2
Investment costs; service line, 0 - 20 kW (EUR/unit)	1600	1600	1600	1600	1400	1800	1400	1800		2
Investment costs; service line, 20 - 50 kW (EUR/unit)	-	-	-	-	-	-	-	-	E	
Investment costs; service line, 50-100 kW (EUR/unit)	-	-	-	-	-	-	-	-	E	
Investment costs; service line, above 100 kW (EUR/unit)	-	-	-	-	-	-	-	-	E	
Investment costs; single line, 0-50 kW (EUR/m)	50	50	50	50	45	55	45	55	F	
Investment costs; single line, 50-250 kW (EUR/m)	50	50	50	50	45	55	45	55	F	
Investment costs; single line, 100-250 kW (EUR/m)	50	50	50	50	45	55	45	55	F	
Investment costs; single line, 250 kW - 1 MW (EUR/m)	50	50	50	50	45	55	45	55	F	
Investment costs; single line, 1 MW - 5 MW (EUR/m)	53	53	53	53	48	59	48	59	G	
Investment costs; single line, 5 MW - 25 MW (EUR/m)	68	68	68	68	62	75	62	75	G	
Investment costs; single line, 25 MW - 100 MW (EUR/m)	-	-	-	-	-	-	-	-		
Reinforcement costs (EUR/MW)	-	-	-	-	-	-	-	-	H	
Type 1 station (EUR/MW)	-	-	-	-	-	-	-	-	I	
Type 2 station (EUR/MW)	-	-	-	-	-	-	-	-	I	
Investments, percentage installation	80%	80%	80%	80%	70%	90%	70%	90%		2
Investments, percentage materials	20%	20%	20%	20%	10%	30%	10%	30%		2
Fixed O&M (EUR/MW/year)	750	750	750	750	600	900	600	900		2
Variable O&M (EUR/MWh)	0	0	0	0	0	0	0	0		2

Notes

- A There are no general data available for the Danish gas system. The stated losses are based on a European survey. European gas networks are generally older than the Danish system. Therefore, it is expected the losses from the Danish system are significantly lower than stated in the table. The lack of data explains the high uncertainty stated.
- B As mentioned in the qualitative description, new gas systems will be constructed without stations in the distribution network
- C There is no power consuming parts in the distribution system consumption for preheating before expansion from 40 to 4 bar. Expansion from 19 or 16 bar to 4 bar doesn't require preheating. Losses are included in the number stated for lines, see note A.
- D Based on given case
- E Capacity range not relevant for given case
- F Stated number is for Ø40 pipes - the smallest pipe applied. It is only marginally cheaper to apply smaller pipes.
- G Two pipes were chosen for each interval (one for the lowest power level and one for the highest). The average of these two is stated in the table.
- H Reinforcement not relevant
 - I No station will be installed for the distribution network

References

- 1 Survey methane emissions for gas transmission and distribution in Europe Marcogaz WG-ME-14-26 29/02/2016
- 2 HMN Naturgas

Table 8: Gas distribution, suburban

Technology	Natural Gas Distribution, suburban areas									
	2015	2020	2030	2050	Uncertainty (2020)		Uncertainty (2050)		Note	Ref
Energy/technical data	Lower		Upper		Lower		Upper			
Energy losses, lines (%)	0,26	0,26	0,26	0,26	0,05	0,3	0,05	0,3	A	1
Energy losses, stations (%)	-	-	-	-	-	-	-	-	B	
Auxiliary electricity consumption (% of energy delivered)	0	0	0	0	0	0	0	0	C	
Technical life time (years)	50	50	50	50	50	80	50	80		2
Typical load profile (-)	-	-	-	-	-	-	-	-		
- Residential	0,2	0,2	0,2	0,2	0,15	0,25	0,15	0,25	D	
- Commercial	N/A	N/A	N/A	N/A					D	
Construction time (years)	0,4	0,4	0,4	0,4	0,3	0,5	0,3	0,5		2
Financial data										
Distribution network costs (EUR/MWh/year) Suburban	150	150	150	150	140	170	140	170		2
Investment costs; service line, 0 - 20 kW (EUR/unit)	1600	1600	1600	1600	1400	1800	1400	1800		2
Investment costs; service line, 20 - 50 kW (EUR/unit)	-	-	-	-	-	-	-	-	E	
Investment costs; service line, 50-100 kW (EUR/unit)	-	-	-	-	-	-	-	-	E	
Investment costs; service line, above 100 kW (EUR/unit)	-	-	-	-	-	-	-	-	E	
Investment costs; single line, 0-50 kW (EUR/m)	53	53	53	53	48	59	48	59	F	
Investment costs; single line, 50-250 kW (EUR/m)	53	53	53	53	48	59	48	59	F	
Investment costs; single line, 100-250 kW (EUR/m)	53	53	53	53	48	59	48	59	F	
Investment costs; single line, 250 kW - 1 MW (EUR/m)	53	53	53	53	48	59	48	59	F	
Investment costs; single line, 1 MW - 5 MW (EUR/m)	60	60	60	60	54	66	54	66	G	
Investment costs; single line, 5 MW - 25 MW (EUR/m)	87	87	87	87	78	95	78	95	G	
Investment costs; single line, 25 MW - 100 MW (EUR/m)	-	-	-	-	-	-	-	-		
Reinforcement costs (EUR/MW)	-	-	-	-	-	-	-	-	H	
Type 1 station (EUR/MW)	-	-	-	-	-	-	-	-	I	
Type 2 station (EUR/MW)	-	-	-	-	-	-	-	-	I	
Investments, percentage installation	80%	80%	80%	80%	70%	90%	70%	90%		2
Investments, percentage materials	20%	20%	20%	20%	10%	30%	10%	30%		2
Fixed O&M (EUR/MW/year)	310	310	310	310	250	370	250	370		2
Variable O&M (EUR/MWh)	0	0	0	0	0	0	0	0		2

Notes

- A There are no general data available for the Danish gas system. The stated losses are based on a European survey. European gas networks are generally older than the Danish system. Therefore, it is expected the losses from the Danish system are significantly lower than stated in the table. The lack of data explains the high uncertainty stated.
- B As mentioned in the qualitative description, new gas systems will be constructed without stations in the distribution network
- C There is no power consuming parts in the distribution system
- D Based on given case
- E Capacity range not relevant for given case
- F Stated number is for Ø40 pipes - the smallest pipe applied. It is only marginally cheaper to apply smaller pipes.
- G Two pipes were chosen for each interval (one for the lowest power level and one for the highest). The average of these two is stated in the table.
- H Reinforcement not relevant
- I No station will be installed for the distribution network

References

- 1 Survey methane emissions for gas transmission and distribution in Europe Marcogaz WG-ME-14-26
29/02/2016
- 2 HMN Naturgas

Table 9: Gas distribution, city

Technology	Natural Gas Distribution, city areas									
	2015	2020	2030	2050	Uncertainty (2020)		Uncertainty (2050)		Note	Ref
Energy/technical data					Lower	Upper	Lower	Upper		
Energy losses, lines (%)	-	-	-	-	-	-	-	-	A	1
Energy losses, stations (%)	-	-	-	-	-	-	-	-	B	1
Auxiliary electricity consumption (% of energy delivered)	0	0	0	0	0	0	0	0	C	1
Technical life time (years)	50	50	50	50	50	80	50	80		1
Typical load profile (-)									D	
- Residential	0,2	0,2	0,2	0,2	0,15	0,25	0,15	0,25	D	
- Commercial	N/A	N/A	N/A	N/A	N/A	N/A	N/A	N/A	D	
Construction time (years)	0,4	0,4	0,4	0,4	0,3	0,5	0,3	0,5		1
Financial data										
Distribution network costs (EUR/MWh/year) City	10	10	10	10	10	10	10	10		1
Investment costs; service line, 0 - 20 kW (EUR/unit)	-	-	-	-	-	-	-	-		
Investment costs; service line, 20 - 50 kW (EUR/unit)	-	-	-	-	-	-	-	-		
Investment costs; service line, 50-100 kW (EUR/unit)	-	-	-	-	-	-	-	-		
Investment costs; service line, above 100 kW (EUR/unit)	15.000	15.000	15.000	15.000	12.000	18.000	12.000	18.000	E	1
Investment costs; single line, 0-50 kW (EUR/m)	64	64	64	64	58	70	58	70		1
Investment costs; single line, 50-250 kW (EUR/m)	64	64	64	64	58	70	58	70		1
Investment costs; single line, 100-250 kW (EUR/m)	64	64	64	64	58	70	58	70		1
Investment costs; single line, 250 kW - 1 MW (EUR/m)	64	64	64	64	58	70	58	70		1
Investment costs; single line, 1 MW - 5 MW (EUR/m)	72	72	72	72	65	79	65	79		1
Investment costs; single line, 5 MW - 25 MW (EUR/m)	104	104	104	104	94	114	94	114		1
Investment costs; single line, 25 MW - 100 MW (EUR/m)	-	-	-	-	-	-	-	-	F	
Reinforcement costs (EUR/MW)	-	-	-	-	-	-	-	-	F	
Type 1 station (EUR/MW)	-	-	-	-	-	-	-	-	F	
Type 2 station (EUR/MW)	-	-	-	-	-	-	-	-	F	
Investments, percentage installation	80%	80%	80%	80%	70%	90%	70%	90%		1
Investments, percentage materials	20%	20%	20%	20%	10%	30%	10%	30%		1
Fixed O&M (EUR/MW/year)	20	20	20	20	16	24	16	24		1
Variable O&M (EUR/MWh)	0	0	0	0	0	0	0	0		1

Notes

- A For the defined case "New distribution in existing densely populated areas, city centres etc." it is assessed the natural gas based heating will be designed with one boiler and heat is distributed to the end users by a local district heating system. This means that the local natural gas system will only consist of a service line with a capacity of 1.5 MW supplying a boiler as well a meter and a pressure regulator. Therefore, losses are neglected
- B As mentioned in the qualitative description, new gas systems will be constructed without stations in the distribution network
- C There is no power consuming parts in the distribution system
- D Based on given case
- E Stated number is for a service line supplying 1,5 MW.
- F Not relevant, see note A

References

- 1 HMN Naturgas

Table 10: Gas distribution, new developed area

Technology	Natural Gas Distribution, New developed areas									
	2015	2020	2030	2050	Uncertainty (2020)		Uncertainty (2050)		Note	Ref
Energy/technical data					Lower	Upper	Lower	Upper		
Energy losses, lines (%)	0,26	0,26	0,26	0,26	0,05	0,3	0,05	0,3	A	1
Energy losses, stations (%)	-	-	-	-	-	-	-	-	B	
Auxiliary electricity consumption (% of energy delivered)	0	0	0	0	0	0	0	0	C	
Technical life time (years)	50	50	50	50	50	80	50	80		2
Typical load profile (-)	-	-	-	-	-	-	-	-		
- Residential	0,2	0,2	0,2	0,2	0,15	0,25	0,15	0,25	D	
- Commercial	N/A	N/A	N/A	N/A					D	
Construction time (years)	0,4	0,4	0,4	0,4	0,3	0,5	0,3	0,5		2
Financial data										
Distribution network costs (EUR/MWh/year) City	270	270	270	270	240	300	240	300		2
Investment costs; service line, 0 - 20 kW (EUR/unit)	1600	1600	1600	1600	1400	1800	1400	1800		2
Investment costs; service line, 20 - 50 kW (EUR/unit)	-	-	-	-	-	-	-	-	E	
Investment costs; service line, 50-100 kW (EUR/unit)	-	-	-	-	-	-	-	-	E	
Investment costs; service line, above 100 kW (EUR/unit)	-	-	-	-	-	-	-	-	E	
Investment costs; single line, 0-50 kW (EUR/m)	47	47	47	47	42	51	42	51	F	
Investment costs; single line, 50-250 kW (EUR/m)	47	47	47	47	42	51	42	51	F	
Investment costs; single line, 100-250 kW (EUR/m)	47	47	47	47	42	51	42	51	F	
Investment costs; single line, 250 kW - 1 MW (EUR/m)	47	47	47	47	42	51	42	51	F	
Investment costs; single line, 1 MW - 5 MW (EUR/m)	50	50	50	50	45	55	45	55	G	
Investment costs; single line, 5 MW - 25 MW (EUR/m)	63	63	63	63	57	70	57	70	G	
Investment costs; single line, 25 MW - 100 MW (EUR/m)	-	-	-	-	-	-	-	-		
Reinforcement costs (EUR/MW)	-	-	-	-	-	-	-	-	H	
Type 1 station (EUR/MW)	-	-	-	-	-	-	-	-	I	
Type 2 station (EUR/MW)	-	-	-	-	-	-	-	-	I	
Investments, percentage installation	80%	80%	80%	80%	70%	90%	70%	90%		2
Investments, percentage materials	20%	20%	20%	20%	10%	30%	10%	30%		2
Fixed O&M (EUR/MW/year)	920	920	920	920	740	1100	740	1100		2
Variable O&M (EUR/MWh)	0	0	0	0	0	0	0	0		2

Notes

- A There are no general data available for the Danish gas system. The stated losses are based on a European survey. European gas networks are generally older than the Danish system. Therefore, it is expected the losses from the Danish system are significantly lower than stated in the table. The lack of data explains the high uncertainty stated.
- B As mentioned in the qualitative description, new gas systems will be constructed without stations in the distribution network
- C There is no power consuming parts in the distribution system
- D Based on given case
- E Capacity range not relevant for given case
- F Stated number is for Ø40 pipes - the smallest pipe applied. It is only marginally cheaper to apply smaller pipes.
- G Two pipes were chosen for each interval (one for the lowest power level and one for the highest). The average of these two is stated in the table.
- H Reinforcement not relevant
- I No station will be installed for the distribution network

References

- 1 Survey methane emissions for gas transmission and distribution in Europe Marcogaz WG-ME-14-26
29/02/2016
- 2 HMN Naturgas

113 District heating distribution and transmission grid

Contact information:

Danish Energy Agency: Rikke Næraa, rin@ens.dk

Energinet.dk: Rune Duban Grandal, rdg@energinet.dk

Author: Kasper Qvist, Kasper.Qvist@sweco.dk

Reviewer: Johnny Iversen, Johnny.Iversen@sweco.dk,

Reviewer: Christian Nørr Jacobsen, ChristianNorr.Jacobsen@sweco.dk

Qualitative description

Brief technology description

Hot water based district heating (DH) grids are used for transportation of centrally produced heat to consumers, residential as well as commercial. A variety of technologies can be used for heat production e.g. combined heat and power (CHP) plants, boilers, large-scale heat pumps, large electric boilers, excess heat and large-scale solar heating. Furthermore DH can integrate storage capacity which partially can decouple heat production from heat demand. District heating in Denmark is primarily used for space heating and domestic hot water. However, it can also be used for industrial purposes or production of cooling through absorption chillers. By centralizing the heat production it is possible to achieve a very efficient heat production e.g. by cogeneration of heat and electricity at CHP plants.

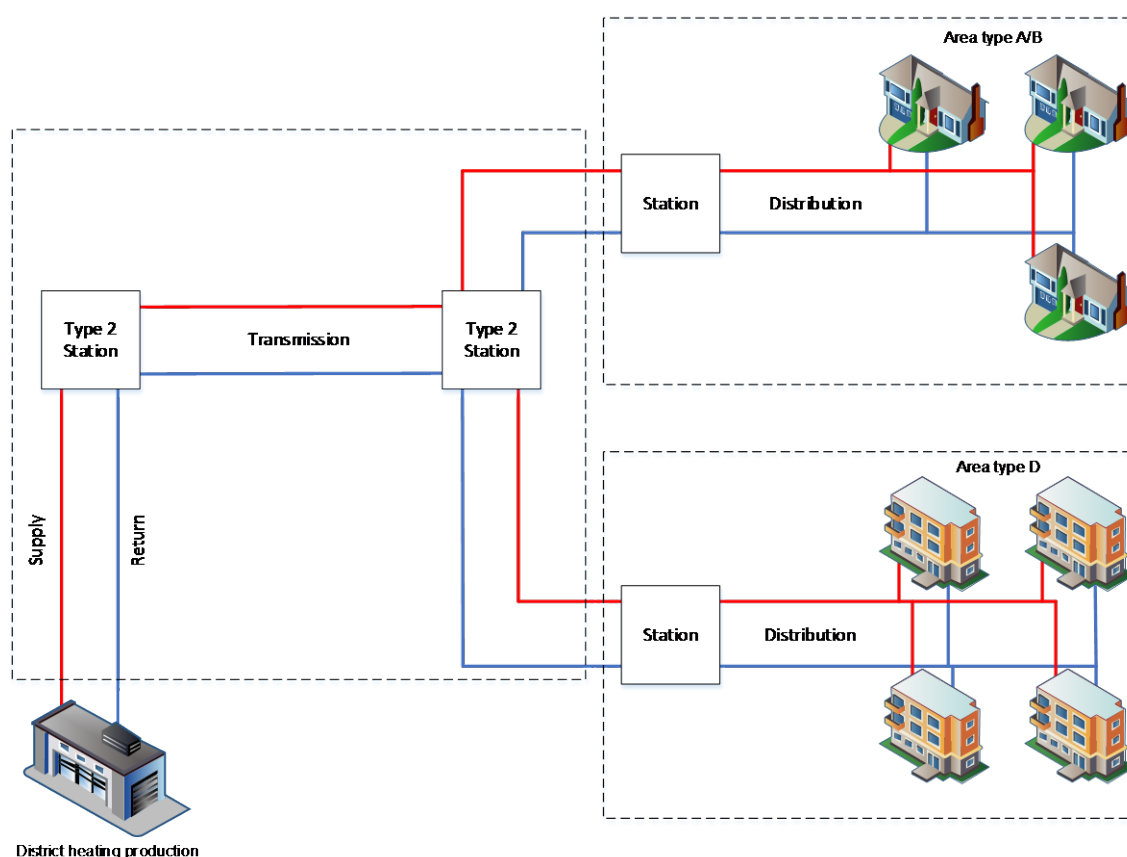

Figure 1 Illustration of district heating system

DH systems can vary in size from covering large areas like the Greater Copenhagen Area to small villages consisting of only a limited number of houses.

Large district heating systems may consist of both a transmission grid and a distribution grid. The distribution grid distributes the heat locally at a lower temperature/pressure while the transmission grid transports heat over long distances at higher temperature/pressure, typically from large heat producing units to distribution grids.

In the 1980's and 1990's a substantial development of DH took place in Denmark causing the very widespread use of district heating today. In large cities like Copenhagen and Aarhus, the central power plants are all CHP plants producing district heating in cogeneration with electricity. Until recently the fuels for these large central have mainly been coal and natural gas. However, in the recent years, several of the large central power plant units have been converted to biomass and more are planned to come.

District heating is also widely spread in a number of minor cities, towns and even villages around Denmark. In these areas district heating is mainly produced on small-scale CHP plants or heat only boilers. The fuels used are mainly natural gas and biomass. However, solar district heating has been growing rapidly over the last couple of years.

In the recent years, there has been a growing focus to develop the next generation of district heating also referred to as 4th generation district heating. The new generation of district heating is characterized by lower system temperatures along with a higher integration of renewable energy sources and a more intelligent interaction between different energy sources.

According to [1] approximately 64 % of the Danish households were supplied with district heating in 2015. In line with Danish and international energy and climate policies, district heating can play a big part in phasing out fossil fuels, making it possible that district heating will constitute an even larger percentage of the total heat supply in the future. However, this depends largely on district heating's competitiveness compared to individual heat solutions.

Input

Input to a DH grid is heat from various sources, e.g. CHP plants, boilers, large-scale heat pumps, excess heat or large-scale solar heating etc.

Output

The output is the same as the input, heat. However, due to grid losses the amount of heat delivered from the DH grid is lower than the amount delivered to it.

Energy balance

Transportation of thermal energy in district heating pipes results in heat losses to the surroundings. The heat loss is in particular dependent on the length and temperature difference (between pipes and its surroundings) of the system and varies a lot from one system to another. Average grid losses are in the range of 15-20 % [2] [5]. In very large and dense systems, the loss can be as low as approximately 5 % while it can be more than 50 % in systems of very poor condition.

In heat exchanger efficiency is approx. 95 % of the delivered heat. Heat losses in pumping stations are negligible. Heat exchanger stations are normally only found in connection with transmission grids.

Most of the electricity for pumping is transformed to heat losses to the surroundings. A portion of this heat loss contributes to heating the district heating water.

Description of transmission system

District heating transmission systems are used to transfer large quantities of thermal energy between different distribution areas using water as a media. Transmission systems operate at a higher temperature and pressure levels (<110 °C and 25 bar) compared to distribution systems.

Heat is delivered from transmission systems to distribution systems typically through heat exchanger stations in order to reduce the pressure and temperature levels.

Transmission systems often include pressure boosting pumping stations in order to prevent otherwise necessary upgrading of the grid’s pressure level.

Description of distribution system

A district heating distribution system distributes heat to consumers in a distribution area using water as a media. Distribution systems often operate with supply temperatures between 70-80 °C. However, due to an increasing attention to reducing temperature levels some areas operate at temperatures as low as 55-60 °C during the summer months [1]. Development for lowering the supply temperature even further is ongoing and decoupling of space heating and domestic hot water production is seen more and more often. This is due to different temperature requirements for space heating and production of domestic hot water, e.g. floor heating only requires 30-35 °C whereas production of domestic hot water requires at least 50 °C to prevent the growth of legionella bacteria. By decoupling space heating and production of domestic hot water it is then possible to achieve several energy efficiency benefits in a district heating system.

Pressure levels are usually between 6.5 and 16 bars.

Space requirement

Space requirement during construction for the trenching of district heating pipes varies depending on area conditions - paved or unpaved areas. Also, the permanent space requirement varies depending on whether twin pipes or single pipes are used. In unpaved areas, district heating pipes are laid in trenches with sloped walls requiring more surface area whereas vertical trench walls typically are used in paved areas [1] [2].

	Paved areas	Unpaved areas
Single Pipes	1-1.1	1.6-1.7
Twin Pipes	0.7-0.8	1.3-1.4

Table 1 Space requirements, m² per MW per m (Based on a DN100 pipe assuming a ΔT of 35 °C).

Advantages/disadvantages

One of the big advantages of district heating systems is the high degree of flexibility it allows in terms of heat sources and operation of heat producing units. District heating allows numerous different production units in the same grid making it possible to prioritize the preferred heat production, e.g. the most efficient, economic, environmental friendly etc. This characteristic also makes district heating systems a secure solution for the future, since the current heat producing technologies can relatively easily be replaced when future better technologies become available.

District heating systems also allow for the utilization of geothermal heat, heat from waste incineration and surplus heat from industrial processes – heat sources than cannot be used for individual solutions.

If a district heating system is connected to a heat storage and heat is produced at CHP plants, large heat pumps or large electric boilers, the district heating system can offer flexibility services to the electricity grid helping to integrate a higher share of intermittent power producing technologies e.g. wind and solar power. This is already happening today and will be even more important in the future as part of several other Smart Energy solutions.

The use of seasonal heat storage allows for the integration in the district heating system of large scale solar heating plants and hence takes advantage outside the summer season of the economically advantageous and CO₂-neutral solar heat.

Finally, district heating is a well-proven and reliable technology that offers easy operation for the heat consumers. Heating from district heating is as convenient for the consumer as any other utility (water, electricity) by moving the responsibility of operation and maintenance away from the consumer to professional service providers.

The disadvantages of district heating systems are the high initial investment costs, heat losses in the system and the need for electricity to pump water through the pipes.

Environment

Establishment of district heating grids have a minimal environmental impact during construction. The environmental conditions during operation are solely linked to the individual production technology and units.

Research and development perspectives

Low temperature district heating (LTDH) has been a topic that has been investigated thoroughly for several years and through numerous projects technical concepts have been developed and demonstrated to a level where LTDH now is a commercial and reliable technology. LTDH is defined as having a supply temperature of 50-55 °C and a return temperature of 25-30 °C at the consumer.

During the last couple of years, concepts for ultra-low temperature district heating (ULTDH) have been developed, tested and demonstrated. ULTDH is a further development of low temperature district heating (LTDH) and has been defined as having a supply temperature below 45 °C and a return temperature of 20-25 °C at the consumer.

With ULTDH the link between district heating supply temperature and temperature requirement of domestic hot water (DHW) temperature is separated. DHW can be produced using a micro booster (small heat pump) or an electrical heater, and the risk of legionella bacteria can be avoided by the use of instant heat exchangers.

ULTDH is still a developing technology that has not yet been fully commercialized. However, full-scale demonstration projects have shown that ULTDH is suitable for low-energy buildings as well as existing buildings if done correctly.

The advantages of LTDH and ULTDH are lower heat loss in the district heating system due to a lower temperature difference to the surroundings combined with increased fuel efficiency at the production plants.

Additionally lower district heating temperatures also make it possible to use a wider range of heat sources including surplus heat from industrial processes and renewable energy sources. Many renewable technologies also have better performance at lower temperatures meaning lower district heating temperatures can result in a better and more efficient integration of renewable energy sources.

The resulting energy savings could result in decreased fuel consumption. However, if it becomes necessary to boost the temperature at the consumer – using either a heat pump or electric heating – the extra energy consumption used in the boosting may offset the energy savings in the LTDH or ULTDH system.

LTDH and ULTDH grids are not considered to be more expensive to build than traditional district heating, they might even be slightly cheaper.

LTDH and ULTDH are especially attractive in areas with a low heat density e.g. areas with new low-energy buildings.

Examples of market standard technology

Where possible, twin pipes should be used instead of single pipes as this ensures reduced heat losses as well as construction costs.

For smaller dimensions, (DN 15-DN 40) flexible pipes are preferable, whereas steel pipes will be necessary for larger dimensions. Twin pipes are not available in dimensions larger than DN 200.

Flexible pipes are often used as service lines, as the flexible material makes the installation easier. Service lines are often a plastic (PEX) pipe and can be supplied with an aluminum layer to ensure diffusion resistance. Service lines can also consist of flexible twin pipes with copper pipes and single lines with pipes of (cold-rolled) steel [4].

Both flexible and straight pipes are recommended with a diffusion barrier between the insulation and the polyethylene (PE) casing to ensure a low and unchanged thermal conductivity over time.



Figure 1: An example of a flexible twin pipe and a steel twin pipe

District heating conversion in Birkerød – Conversion from individual natural gas boilers to district heating in parts of Birkerød. More than 50 km of district heating pipes in sizes ranging up DN 300 connects consumers to district heating from I/S Norfors in Hørsholm. The system has a peak capacity of approximately 25 MW and delivers more than 70.000 MWh annually [5].

Capacity upgrade in Aarhus – Upgrade of the district heating capacity to the district Højbjerg in Aarhus. New 18 MW heat exchanger central and 1.6 km DN 250 transmission pipe. The heat exchanger central connects the transmission system to three separate distribution systems, each with its own operating pressure due to large height differences in the area [6].

Prediction of performance and costs

Prediction of cost is based on Sweco’s experience figures from district heating projects correlated with data from Svensk Fjärrvärmes Cost Catalog, which is a detailed database of costs covering labor and material cost based on actual construction costs [6].

District heating grids are a mature and commercial technology with large deployment. Pipe prices have had a very low variation and have more or less stabilized over the last couple of years. No significant changes in performance and costs are expected to happen to current technology in the foreseeable future. However, new technology, changes in production methods and changes in consumption patterns could possibly have an impact on performance and cost development.

Costs for labor, e.g. welding, excavation etc. are very dependent on geography and area type as considerable variations can be observed. Further, the general market conditions influence these costs.

Uncertainty

Performance data of district heating grids, such as energy losses, technical life-time and load profile typically depends on a number of project specific details and can be difficult to generalize.

Furthermore, if large changes were to happen on the basic design and operation of district heating grids it will have an impact on both performance and costs that are difficult to anticipate.

References

- [1] Årsberetning 2015, Dansk Fjernvarme, 2015
http://www.danskfjernvarme.dk/~media/danskfjernvarme/omos/dansk%20fjernvarme/%C3%A5rsberetning%202015_endelig%20udgave.pdf
- [2] Sweco
- [3] Stålrør, Isoplus, 2016
<http://www.isoplus.dk/staalroer-1968>
- [4] Technology Data for Energy Plants - Individual Heating Plants and Energy Transport, Danish Energy Agency, Oct. 2013
- [5] Følg fjernvarmeprojektet i Birkerød, Norfors, 2016
<http://www.norfors.dk/da-DK/Fjernvarme/F%C3%B8lg-Fjernvarmeprojektet-i-Birker%C3%B8d.aspx>
- [6] Brøndum
<http://www.brondum.dk/referencer/affaldvarme-aarhus-stenvej/>
- [7] Svensk Fjärrvärme, 2013
- [8] Nøgletal 2016, Dansk Fjernvarme, 2016
<http://www.danskfjernvarme.dk/viden-om/aarsstatistik/statistik-2015-2016>

Data sheets

Table 11: District heating transmission

Technology	District Heating Transmission									
	2015	2020	2030	2050	Uncertainty (2020)		Uncertainty (2050)		Note	Ref
Energy/technical data					Lower	Upper	Lower	Upper		
Energy losses, lines 1-20 MW (%)	3	3	3	3	1	5	1	5	A	1, 2
Energy losses, lines 20-100 MW (%)	1	1	1	1	0.5	2	0.5	2	A	1, 2
Energy losses, lines above 100 MW (%)	0.5	0.5	0.5	0.5	0.2	0.7	0.2	0.7	A	1, 2
Energy losses, Heat exchanger stations (%)	5	5	5	5	2	7	2	7		1
Energy losses, Pumping stations (%)	N/A	N/A	N/A	N/A	N/A	N/A	N/A	N/A	G	1
Auxiliary electricity consumption (% energy transmitted)	2	2	2	2	0.5	5	0.5	5		1, 4
Technical life time (years)	40	40	40	40	30	50	30	50	B	1, 2
Typical load profile (-)	0.5	0.5	0.5	0.5	0.4	0.6	0.4	0.6		1
Construction time (years)	4	4	4	4	3	5	3	5		1
Financial data										
Investment costs										
Investment costs; single line, 0 - 50 MW (EUR/MW/m)	25	25	25	25	See Note	See Note	See Note	See Note	C, D	1, 3
Investment costs; single line, 50-100 MW (EUR/MW/m)	12	12	12	12	See Note	See Note	See Note	See Note	C, D	1, 3
Investment costs; single line, 100 - 250 MW (EUR/MW/m)	9	9	9	9	See Note	See Note	See Note	See Note	C, D	1, 3
Investment costs; single line, 250-500 MW (EUR/MW/m)	6	6	6	6	See Note	See Note	See Note	See Note	C, D	1, 3
Investment costs; single line, 500-1000 MW (EUR/MW/m)	N/A	N/A	N/A	N/A	N/A	N/A	N/A	N/A		
Investment costs; single line, above 1000 MW (EUR/MW/m)	N/A	N/A	N/A	N/A	N/A	N/A	N/A	N/A		
Reinforcement costs (EUR/MW)	N/A	N/A	N/A	N/A	N/A	N/A	N/A	N/A	E	
Investment costs; [type 1] station (EUR/MW)	115.000	115.000	115.000	115.000	92.000	138.000	92.000	138.000		1
Investment costs; [type 2] station (EUR/MW)	105.000	105.000	105.000	105.000	84.000	126.000	84.000	126.000		1
Investments, percentage installation	60%	60%	60%	60%	50%	75%	50%	75%	C	1, 3
Investments, percentage materials	40%	40%	40%	40%	25%	50%	25%	50%	C	1, 3
Fixed O&M (EUR/MW/km/year)	N/A	N/A	N/A	N/A	N/A	N/A	N/A	N/A		
Variable O&M (EUR/MWh/km)	0.1	0.1	0.1	0.1	0.05	1.5	0.05	1.5		1, 4

Notes

- A The loss is per km of transmission line
- B The technical life time of a district heating pipe is minimum 30 years. However the life time can be substantially longer depending on operation conditions e.g. temperature variation, soil conditions etc.
- C An unpaved area is assumed
- D Two district heating pipes were chosen for each interval (one for the lowest power level and one for the highest). The average of these two is stated in the table. The cost is per trench meter.
- E Depends on the scale of the transmission grid and supply strategy of reserve capacity. Therefore, it is not possible to generalize these costs.
- G Energy losses in pumping stations can be considered negligible

References

- 1 Based on Sweco experience figures
- 2 LOGSTOR A/S
- 3 Consolidated with data from Svensk Fjärrvärme
- 4 Consolidated with data from Dansk Fjernvarmes Årsstatistik 2016

Table 12: District heating distribution, rural

Technology	District Heating Distribution, Rural								Note	Ref
	2015	2020	2030	2050	Uncertainty (2020)		Uncertainty (2050)			
Energy/technical data					Lower	Upper	Lower	Upper		
Energy losses, lines (%)	15	15	15	15	10	20	10	20	A, B	1
Energy losses, Heat exchanger stations (%)	5	5	5	5	2	7	2	7	C	2
Auxiliary electricity consumption (% of energy delivered)	2	2	2	2	0,5	3	0,5	3		2
Technical life time (years)	40	40	40	40	30	50	30	50	D	1
Typical load profile (-)										
- Residential	0.2	0.2	0.2	0.2	0.15	0.25	0.15	0.25		
- Commercial	N/A	N/A	N/A	N/A	N/A	N/A	N/A	N/A		
Construction time (years)	1	1	1	1	0.5	1.5	0.5	1.5		
Financial data										
Distribution network costs (EUR/MWh/year), Rural	720	720	720	720	See Note	See Note	See Note	See Note	E, F	2, 3
Investment costs; service line, 0 - 20 kW (EUR/unit)	3.785	3.785	3.785	3.785	See Note	See Note	See Note	See Note	F, G	2, 3
Investment costs; service line, 20 - 50 kW (EUR/unit)	4.135	4.135	4.135	4.135	See Note	See Note	See Note	See Note	F, G	2, 3
Investment costs; service line, 50-100 kW (EUR/unit)	4.735	4.735	4.735	4.735	See Note	See Note	See Note	See Note	F, G	2, 3
Investment costs; service line, above 100 kW (EUR/unit)	N/A	N/A	N/A	N/A	N/A	N/A	N/A	N/A		
Investment costs; single line, 0-50 kW (EUR/m)	280	280	280	280	See Note	See Note	See Note	See Note	F, H	2, 3
Investment costs; single line, 50-250 kW (EUR/m)	355	355	355	355	See Note	See Note	See Note	See Note	F, H	2, 3
Investment costs; single line, 100-250 kW (EUR/m)	370	370	370	370	See Note	See Note	See Note	See Note	F, H	2, 3
Investment costs; single line, 250 kW - 1 MW (EUR/m)	460	460	460	460	See Note	See Note	See Note	See Note	F, H	2, 3
Investment costs; single line, 1 MW - 5 MW (EUR/m)	640	640	640	640	See Note	See Note	See Note	See Note	F, H	2, 3
Investment costs; single line, 5 MW - 25 MW (EUR/m)	1.185	1.185	1.185	1.185	See Note	See Note	See Note	See Note	F, H	2, 3
Investment costs; single line, 25 MW - 100 MW (EUR/m)	N/A	N/A	N/A	N/A	N/A	N/A	N/A	N/A		
Reinforcement costs (EUR/MW)	N/A	N/A	N/A	N/A	N/A	N/A	N/A	N/A		
Heat exchanger station (EUR/MW)	100.000	100.000	100.000	100.000	80.000	120.000	80.000	120.000	I	2
Pumping station (EUR/MW)	90.000	90.000	90.000	90.000	72.000	108.000	72.000	108.000	I	2
Investments, percentage installation	85%	85%	85%	85%	80%	90%	80%	90%	F	2
Investments, percentage materials	15%	15%	15%	15%	10%	20%	10%	20%	F	2
Fixed O&M (EUR/MW/year)	N/A	N/A	N/A	N/A	N/A	N/A	N/A	N/A		
Variable O&M (EUR/MWh)	1.5	1.5	1.5	1.5	1	2	1	2		2, 4
Technology specific data										
Heat exchanger station below 1 MW(EUR/MW)	265.000	265.000	265.000	265.000	212.000	318.000	212.000	318.000		2
Pumping station below 1 MW (EUR/MW)	240.000	240.000	240.000	240.000	192.000	288.000	192.000	288.000		2

Notes

- A For entire distribution network
- B Use of single pipes would lead to a higher heat loss
- C For heat exchanger stations the heat loss is below 5 % and varies depending on the level of thermal insulation. For pump stations the heat loss is negligible.
- D The technical life time of a district heating pipe is minimum 30 years. However the life time can be substantially longer depending on operation conditions e.g. temperature variation, soil conditions etc.
- E The distribution network costs are based on the total cost for the area type case divided by the yearly heat demand. An unpaved area is assumed for all economic values
- F An paved area is assumed for the distribution network. For service lines 50 % unpaved and 50 % paved area is assumed.
- G Cost of service lines is based on an average service line length of 15 meters. Two service lines were chosen for each interval (one for the lowest power level and one for the highest). The average of these two is stated in the table. Service lines above 100 kW are not relevant in the specific area type.
- H Two district heating pipes were chosen for each interval (one for the lowest power level and one for the highest). The average of these two is stated in the table. The cost is per trench meter. Power levels above 25 MW are not relevant in the specific area type.
- I The value stated is for stations above 1 MW. Investment costs per MW for stations below 1 MW are very different compared to stations above 1 MW as specified under Technology specific data.

References

- 1 LOGSTOR A/S
- 2 Based on Sweco experience figures
- 3 Consolidated with data from Svensk Fjärrvärme
- 4 Consolidated with data from Dansk Fjernvarmes Årsstatistik 2016

Table 13: District heating distribution, suburban

Technology	District Heating Distribution, Suburban								Note	Ref
	2015	2020	2030	2050	Uncertainty (2020)		Uncertainty (2050)			
Energy/technical data					Lower	Upper	Lower	Upper		
Energy losses, lines (%)	14	14	14	14	10	17	10	17	A, B	1
Energy losses, Heat exchanger stations (%)	5	5	5	5	2	7	2	7	C	2
Auxiliary electricity consumption (% of energy delivered)	2	2	2	2	0,5	3	0,5	3		2
Technical life time (years)	40	40	40	40	30	50	30	50	D	1
Typical load profile (-)										
- Residential	0.2	0.2	0.2	0.2	0.15	0.25	0.15	0.25		
- Commercial	N/A	N/A	N/A	N/A						
Construction time (years)	1	1	1	1	0.5	1.5	0.5	1.5		
Financial data										
Distribution network costs (EUR/MWh/year) Suburban	655	655	655	655	See Note	See Note	See Note	See Note	E, F	2, 3
Investment costs; service line, 0 - 20 kW (EUR/unit)	3.785	3.785	3.785	3.785	See Note	See Note	See Note	See Note	F, G	2, 3
Investment costs; service line, 20 - 50 kW (EUR/unit)	4.135	4.135	4.135	4.135	See Note	See Note	See Note	See Note	F, G	2, 3
Investment costs; service line, 50-100 kW (EUR/unit)	4.735	4.735	4.735	4.735	See Note	See Note	See Note	See Note	F, G	2, 3
Investment costs; service line, above 100 kW (EUR/unit)	N/A	N/A	N/A	N/A	N/A	N/A	N/A	N/A		
Investment costs; single line, 0-50 kW (EUR/m)	280	280	280	280	See Note	See Note	See Note	See Note	F, H	2, 3
Investment costs; single line, 50-250 kW (EUR/m)	355	355	355	355	See Note	See Note	See Note	See Note	F, H	2, 3
Investment costs; single line, 100-250 kW (EUR/m)	370	370	370	370	See Note	See Note	See Note	See Note	F, H	2, 3
Investment costs; single line, 250 kW - 1 MW (EUR/m)	460	460	460	460	See Note	See Note	See Note	See Note	F, H	2, 3
Investment costs; single line, 1 MW - 5 MW (EUR/m)	640	640	640	640	See Note	See Note	See Note	See Note	F, H	2, 3
Investment costs; single line, 5 MW - 25 MW (EUR/m)	1.185	1.185	1.185	1.185	See Note	See Note	See Note	See Note	F, H	2, 3
Investment costs; single line, 25 MW - 100 MW (EUR/m)	N/A	N/A	N/A	N/A	N/A	N/A	N/A	N/A		
Reinforcement costs (EUR/MW)	N/A	N/A	N/A	N/A	N/A	N/A	N/A	N/A		
Heat exchanger station (EUR/MW)	100.000	100.000	100.000	100.000	80.000	120.000	80.000	120.000	I	2
Pumping station (EUR/MW)	90.000	90.000	90.000	90.000	72.000	108.000	72.000	108.000	I	2
Investments, percentage installation	85%	85%	85%	85%	80%	90%	80%	90%	F	2
Investments, percentage materials	15%	15%	15%	15%	10%	20%	10%	20%	F	2
Fixed O&M (EUR/MW/year)	N/A	N/A	N/A	N/A	N/A	N/A	N/A	N/A		
Variable O&M (EUR/MWh)	1.5	1.5	1.5	1.5	1	2	1	2		2, 4
Technology specific data										
Heat exchanger station below 1 MW(EUR/MW)	265.000	265.000	265.000	265.000	212.000	318.000	212.000	318.000		2
Pumping station below 1 MW (EUR/MW)	240.000	240.000	240.000	240.000	192.000	288.000	192.000	288.000		2

Notes

- A For entire distribution network
- B Use of single pipes would lead to a higher heat loss
- C For heat exchanger stations the heat loss is below 5 % and varies depending on the level of thermal insulation. For pump stations the heat loss is negligible.
- D The technical life time of a district heating pipe is minimum 30 years. However the life time can be substantially longer depending on operation conditions e.g. temperature variation, soil conditions etc.
- E The distribution network costs are based on the total cost for the area type case divided by the yearly heat demand. An unpaved area is assumed for all economic values
- F An paved area is assumed for the distribution network. For service lines 50 % unpaved and 50 % paved area is assumed.
- G Cost of service lines is based on an average service line length of 15 meters. Two service lines were chosen for each interval (one for the lowest power level and one for the highest). The average of these two is stated in the table. Service lines above 100 kW are not relevant in the specific area type.
- H Two district heating pipes were chosen for each interval (one for the lowest power level and one for the highest). The average of these two is stated in the table. The cost is per trench meter. Power levels above 25 MW are not relevant in the specific area type.
- I The value stated is for stations above 1 MW. Investment costs per MW for stations below 1 MW are very different compared to stations above 1 MW as specified under Technology specific data.

References

- 1 LOGSTOR A/S
- 2 Based on Sweco experience figures
- 3 Consolidated with data from Svensk Fjärrvärme
- 4 Consolidated with data from Dansk Fjernvarmes Årsstatistik 2016

Table 14: District heating distribution, city

Technology	District Heating Distribution, City								Note	Ref
	2015	2020	2030	2050	Uncertainty (2020)		Uncertainty (2050)			
Energy/technical data					Lower	Upper	Lower	Upper		
Energy losses, lines (%)	5	5	5	5	3	8	3	8	A, B	1
Energy losses, Heat exchanger stations (%)	5	5	5	5	2	7	2	7	C	2
Auxiliary electricity consumption (% of energy delivered)	2	2	2	2	0,5	3	0,5	3		2
Technical life time (years)	40	40	40	40	30	50	30	50	D	1
Typical load profile (-)										
- Residential	0.2	0.2	0.2	0.2	0.15	0.25	0.15	0.25		
- Commercial	N/A	N/A	N/A	N/A	N/A	N/A	N/A	N/A		
Construction time (years)	1	1	1	1	0.5	1.5	0.5	1.5		
Financial data										
Distribution network costs (EUR/MWh/year) City	150	150	150	150	See Note	See Note	See Note	See Note	E, F	2, 3
Investment costs; service line, 0 - 20 kW (EUR/unit)	4.645	4.645	4.645	4.645	See Note	See Note	See Note	See Note	F, G	2, 3
Investment costs; service line, 20 - 50 kW (EUR/unit)	5.025	5.025	5.025	5.025	See Note	See Note	See Note	See Note	F, G	2, 3
Investment costs; service line, 50-100 kW (EUR/unit)	5.685	5.685	5.685	5.685	See Note	See Note	See Note	See Note	F, G	2, 3
Investment costs; service line, above 100 kW (EUR/unit)	6.195	6.195	6.195	6.195	See Note	See Note	See Note	See Note	F, G, H	2, 3
Investment costs; single line, 0-50 kW (EUR/m)	280	280	280	280	See Note	See Note	See Note	See Note	F, I	2, 3
Investment costs; single line, 50-250 kW (EUR/m)	355	355	355	355	See Note	See Note	See Note	See Note	F, I	2, 3
Investment costs; single line, 100-250 kW (EUR/m)	370	370	370	370	See Note	See Note	See Note	See Note	F, I	2, 3
Investment costs; single line, 250 kW - 1 MW (EUR/m)	460	460	460	460	See Note	See Note	See Note	See Note	F, I	2, 3
Investment costs; single line, 1 MW - 5 MW (EUR/m)	640	640	640	640	See Note	See Note	See Note	See Note	F, I	2, 3
Investment costs; single line, 5 MW - 25 MW (EUR/m)	1.185	1.185	1.185	1.185	See Note	See Note	See Note	See Note	F, I	2, 3
Investment costs; single line, 25 MW - 100 MW (EUR/m)	N/A	N/A	N/A	N/A	N/A	N/A	N/A	N/A		
Reinforcement costs (EUR/MW)	N/A	N/A	N/A	N/A	N/A	N/A	N/A	N/A		
Heat exchanger station (EUR/MW)	100.000	100.000	100.000	100.000	80.000	120.000	80.000	120.000	J	2
Pumping station (EUR/MW)	90.000	90.000	90.000	90.000	72.000	108.000	72.000	108.000	J	2
Investments, percentage installation	85%	85%	85%	85%	80%	90%	80%	90%	F	2
Investments, percentage materials	15%	15%	15%	15%	10%	20%	10%	20%	F	2
Fixed O&M (EUR/MW/year)	N/A	N/A	N/A	N/A	N/A	N/A	N/A	N/A		
Variable O&M (EUR/MWh)	1.5	1.5	1.5	1.5	1	2	1	2		2, 4
Technology specific data										
Heat exchanger station below 1 MW(EUR/MW)	265.000	265.000	265.000	265.000	212.000	318.000	212.000	318.000		2
Pumping station below 1 MW (EUR/MW)	240.000	240.000	240.000	240.000	192.000	288.000	192.000	288.000		2

Notes

- A For entire distribution network
- B Use of single pipes would lead to a higher heat loss
- C For heat exchanger stations the heat loss is below 5 % and varies depending on the level of thermal insulation. For pump stations the heat loss is negligible.
- D The technical life time of a district heating pipe is minimum 30 years. However the life time can be substantially longer depending on operation conditions e.g. temperature variation, soil conditions etc.
- E The distribution network costs are based on the total cost for the area type case divided by the yearly heat demand. An unpaved area is assumed for all economic values
- F An paved area is assumed for the distribution network as well as service lines
- G Cost of service lines is based on an average service line length of 15 meters. Two service lines were chosen for each interval (one for the lowest power level and one for the highest). The average of these two is stated in the table.
- H The value stated is for a DN40 twin pipe. This pipe size is able to deliver up to around 230 kW. If a higher capacity is needed the price will increase.
- I Two district heating pipes were chosen for each interval (one for the lowest power level and one for the highest). The average of these two is stated in the table. The cost is per trench meter. Power levels above 25 MW are not relevant in the specific area type.
- J The value stated is for stations above 1 MW. Investment costs per MW for stations below 1 MW are very different compared to stations above 1 MW as specified under Technology specific data.

References

- 1 LOGSTOR A/S
- 2 Based on Sweco experience figures
- 3 Consolidated with data from Svensk Fjärrvärme
- 4 Consolidated with data from Dansk Fjernvarmes Årsstatistik 2016

Table 15: District heating distribution, new developed area

Technology	District Heating Distribution, New Area								Note	Ref
	2015	2020	2030	2050	Uncertainty (2020)		Uncertainty (2050)			
Energy/technical data					Lower	Upper	Lower	Upper		
Energy losses, lines (%)	18	18	18	18	10	25	10	25	A, B	1
Energy losses, Heat exchanger stations (%)	5	5	5	5	2	7	2	7	C	2
Auxiliary electricity consumption (% of energy delivered)	2	2	2	2	0,5	3	0,5	3		2
Technical life time (years)	40	40	40	40	30	50	30	50	D	1
Typical load profile (-)										
- Residential	0.2	0.2	0.2	0.2	0.15	0.25	0.15	0.25		
- Commercial	N/A	N/A	N/A	N/A	N/A	N/A	N/A	N/A		
Construction time (years)	1	1	1	1	0.5	1.5	0.5	1.5		
Financial data										
Distribution network costs (EUR/MWh/year) New developed residential area	655	655	655	655	See Note	See Note	See Note	See Note	E, F	2, 3
Investment costs; service line, 0 - 20 kW (EUR/unit)	2.925	2.925	2.925	2.925	See Note	See Note	See Note	See Note	F, G	2, 3
Investment costs; service line, 20 - 50 kW (EUR/unit)	3.375	3.375	3.375	3.375	See Note	See Note	See Note	See Note	F, G	2, 3
Investment costs; service line, 50-100 kW (EUR/unit)	3.775	3.775	3.775	3.775	See Note	See Note	See Note	See Note	F, G	2, 3
Investment costs; service line, above 100 kW (EUR/unit)	N/A	N/A	N/A	N/A	N/A	N/A	N/A	N/A		
Investment costs; single line, 0-50 kW (EUR/m)	180	180	180	180	See Note	See Note	See Note	See Note	F, H	2, 3
Investment costs; single line, 50-250 kW (EUR/m)	235	235	235	235	See Note	See Note	See Note	See Note	F, H	2, 3
Investment costs; single line, 100-250 kW (EUR/m)	250	250	250	250	See Note	See Note	See Note	See Note	F, H	2, 3
Investment costs; single line, 250 kW - 1 MW (EUR/m)	320	320	320	320	See Note	See Note	See Note	See Note	F, H	2, 3
Investment costs; single line, 1 MW - 5 MW (EUR/m)	455	455	455	455	See Note	See Note	See Note	See Note	F, H	2, 3
Investment costs; single line, 5 MW - 25 MW (EUR/m)	900	900	900	900	See Note	See Note	See Note	See Note	F, H	2, 3
Investment costs; single line, 25 MW - 100 MW (EUR/m)	N/A	N/A	N/A	N/A	N/A	N/A	N/A	N/A		
Reinforcement costs (EUR/MW)	N/A	N/A	N/A	N/A	N/A	N/A	N/A	N/A		
Heat exchanger station (EUR/MW)	100.000	100.000	100.000	100.000	80.000	120.000	80.000	120.000	I	2
Pumping station (EUR/MW)	90.000	90.000	90.000	90.000	72.000	108.000	72.000	108.000	I	2
Investments, percentage installation	75%	75%	75%	75%	65%	80%	65%	80%	F	2
Investments, percentage materials	25%	25%	25%	25%	20%	35%	20%	35%	F	2
Fixed O&M (EUR/MW/year)	N/A	N/A	N/A	N/A	N/A	N/A	N/A	N/A		
Variable O&M (EUR/MWh)	1.5	1.5	1.5	1.5	1	2	1	2		2, 4
Technology specific data										
Heat exchanger station below 1 MW(EUR/MW)	265.000	265.000	265.000	265.000	212.000	318.000	212.000	318.000		2

Pumping station below 1 MW (EUR/MW)	240.000	240.000	240.000	240.000	192.000	288.000	192.000	288.000		2
-------------------------------------	---------	---------	---------	---------	---------	---------	---------	---------	--	---

Notes

- A For entire distribution network
- B Use of single pipes would lead to a higher heat loss
- C For heat exchanger stations the heat loss is below 5 % and varies depending on the level of thermal insulation. For pump stations the heat loss is negligible.
- D The technical life time of a district heating pipe is minimum 30 years. However the life time can be substantially longer depending on operation conditions e.g. temperature variation, soil conditions etc.
- E The distribution network costs are based on the total cost for the area type case divided by the yearly heat demand. An unpaved area is assumed for all economic values
- F An unpaved area is assumed
- G Cost of service lines is based on an average service line length of 15 meters. Two service lines were chosen for each interval (one for the lowest power level and one for the highest). The average of these two is stated in the table. Service lines above 100 kW are not relevant in the specific area type.
- H Two district heating pipes were chosen for each interval (one for the lowest power level and one for the highest). The average of these two is stated in the table. The cost is per trench meter. Power levels above 25 MW are not relevant in the specific area type.
- I The value stated is for stations above 1 MW. Investment costs per MW for stations below 1 MW are very different compared to stations above 1 MW as specified under Technology specific data.

References

- 1 LOGSTOR A/S
- 2 Based on Sweco experience figures
- 3 Consolidated with data from Svensk Fjärrvärme
- 4 Consolidated with data from Dansk Fjernvarmes Årsstatistik 2016

Table 16: District heating distribution, new developed area with low temperature district heating

Technology	Low Temperature District Heating Distribution, New Area								Note	Ref
	2015	2020	2030	2050	Uncertainty (2020)		Uncertainty (2050)			
Energy/technical data	Lower		Upper		Lower		Upper			
Energy losses, lines (%)	10	10	10	10	8	12	8	12	A, B	1
Energy losses, Heat exchanger stations (%)	5	5	5	5	2	7	2	7	C	2
Auxiliary electricity consumption (% of energy delivered)	2	2	2	2	0,5	3	0,5	3		2
Technical life time (years)	40	40	40	40	30	50	30	50	D	1
Typical load profile (-)										
- Residential	0.2	0.2	0.2	0.2	0.15	0.25	0.15	0.25		
- Commercial	N/A	N/A	N/A	N/A	N/A	N/A	N/A	N/A		
Construction time (years)	1	1	1	1	0.5	1.5	0.5	1.5		
Financial data										
Distribution network costs (EUR/MWh/year) – New area	680	680	680	680	See Note	See Note	See Note	See Note	E, F	2, 3
Investment costs; service line, 0 - 20 kW (EUR/unit)	3.200	3.200	3.200	3.200	See Note	See Note	See Note	See Note	F, G	2, 3
Investment costs; service line, 20 - 50 kW (EUR/unit)	3.375	3.375	3.375	3.375	See Note	See Note	See Note	See Note	F, G	2, 3
Investment costs; service line, 50-100 kW (EUR/unit)	3.850	3.850	3.850	3.850	See Note	See Note	See Note	See Note	F, G	2, 3
Investment costs; service line, above 100 kW (EUR/unit)	N/A	N/A	N/A	N/A	N/A	N/A	N/A	N/A		
Investment costs; single line, 0-50 kW (EUR/m)	180	180	180	180	See Note	See Note	See Note	See Note	F, H	2, 3
Investment costs; single line, 50-250 kW (EUR/m)	235	235	235	235	See Note	See Note	See Note	See Note	F, H	2, 3
Investment costs; single line, 100-250 kW (EUR/m)	250	250	250	250	See Note	See Note	See Note	See Note	F, H	2, 3
Investment costs; single line, 250 kW - 1 MW (EUR/m)	370	370	370	370	See Note	See Note	See Note	See Note	F, H	2, 3
Investment costs; single line, 1 MW - 5 MW (EUR/m)	540	540	540	540	See Note	See Note	See Note	See Note	F, H	2, 3
Investment costs; single line, 5 MW - 25 MW (EUR/m)	955	955	955	955	See Note	See Note	See Note	See Note	F, H	2, 3
Investment costs; single line, 25 MW - 100 MW (EUR/m)	N/A	N/A	N/A	N/A	N/A	N/A	N/A	N/A		
Reinforcement costs (EUR/MW)	N/A	N/A	N/A	N/A	N/A	N/A	N/A	N/A		
Heat exchanger station (EUR/MW)	100.000	100.000	100.000	100.000	80.000	120.000	80.000	120.000	I	2
Pumping station (EUR/MW)	90.000	90.000	90.000	90.000	72.000	108.000	72.000	108.000	I	2
Investments, percentage installation	75%	75%	75%	75%	65%	80%	65%	80%	F	2
Investments, percentage materials	25%	25%	25%	25%	20%	35%	20%	35%	F	2
Fixed O&M (EUR/MW/year)	N/A	N/A	N/A	N/A	N/A	N/A	N/A	N/A		
Variable O&M (EUR/MWh)	1.5	1.5	1.5	1.5	1	2	1	2		2, 4
Technology specific data										

Heat exchanger station below 1 MW(EUR/MW)	265.000	265.000	265.000	265.000	212.000	318.000	212.000	318.000		2
Pumping station below 1 MW (EUR/MW)	240.000	240.000	240.000	240.000	192.000	288.000	192.000	288.000		2

Notes

- A For entire distribution network
- B Use of single pipes would lead to a higher heat loss
- C For heat exchanger stations the heat loss is below 5 % and varies depending on the level of thermal insulation. For pump stations the heat loss is negligible.
- D The technical life time of a district heating pipe is minimum 30 years. However the life time can be substantially longer depending on operation conditions e.g. temperature variation, soil conditions etc.
- E The distribution network costs are based on the total cost for the area type case divided by the yearly heat demand. An unpaved area is assumed for all economic values
- F An unpaved area is assumed
- G Cost of service lines is based on an average service line length of 15 meters. Two service lines were chosen for each interval (one for the lowest power level and one for the highest). The average of these two is stated in the table. Service lines above 100 kW are not relevant in the specific area type.
- H Two district heating pipes were chosen for each interval (one for the lowest power level and one for the highest). The average of these two is stated in the table. The cost is per trench meter. Power levels above 25 MW are not relevant in the specific area type.
- I The value stated is for stations above 1 MW. Investment costs per MW for stations below 1 MW are very different compared to stations above 1 MW as specified under Technology specific data.

References

- 1 LOGSTOR A/S
- 2 Based on Sweco experience figures
- 3 Consolidated with data from Svensk Fjärrvärme
- 4 Consolidated with data from Dansk Fjernvarmes Årsstatistik 2016

Introduction to transport of gases and liquids

Contact Information:

Danish Energy Agency: Laust Riemann, lri@ens.dk

Author: Anne Krog Jensen (COWI)

Publication date

March 2021

Amendments after publication date

Date	Ref.	Description

Abbreviations

Amb.	Ambient condition (P=1.025 bar, T€[-50:50] °C)	LPG	Liquefied petroleum gas
CC	Carbon Capture	M	Mass
CH2	Compressed hydrogen	M/R	Metering and regulation station
CNG	Compressed natural gas	MTPD	Metric ton per day
CNO	Numb of carbon atoms in a chemical molecule	NG	Natural gas
CP	Cathodic protection	NH ₃	Ammonia
DME	Dimethyl-Ether	P	Pressure
DN	Nominal diameter	Pd	Design pressure
dP/dL	Pressure drop per length (bar/km)	PG	Petroleum gas
E	Energy	Pin	Inlet/suction pressure
EIGA	European industrial gases association AISBL	Pmax	Max operation pressure
ESD	Emergency shutdown	Pmin	Min operating pressure
GT	Gross Tonnage	Pout	Outlet/discharge pressure
H ₂	Hydrogen	PSA	Pressure swing adsorption unit (separate components by selective absorption at high pressure and desorption/regeneration at low pressure)
H2NG	Fuel group: include H2 and NG	PSV	Pressure safety valve (protect against overpressure)

HB	Material hardness measured by "Hardness Brinell" method	Q	Energy flow, MW
HC	Hydrocarbons, i.e. molecules that consist of only C and H (C_nH_m)	RE	Renewable power
HHV	Higher heating value	SCC	Stress corrosion cracking
HRC	Material hardness measured by "Hardness Rockwell C" method	SMR	Steam Methane Reforming
L20	Fuel group: include DME, NH_3 and LPG (and ethane)	T	Temperature
LDME	Liquefied dimethyl-ether	Td	Design temperature
LH2	Liquefied hydrogen	US	United States
LHC	Fuel group: All fuels that are liquid at $P=1.025$ bar and $T=50^\circ C$	VLGC	Very large gas carriers/ships
LNG	Liquefied natural gas	W	World
LNH3	Liquefied ammonia		

Purpose and scope

This technology catalogue provides an overview of the different technologies for transporting fuels with specific focus on Hydrogen (H₂), Ammonia (NH₃), Dimethyl Ether (DME) and Liquid organic hydrogen carrier (LOHC). The catalogue provides cost and performance data for transportation via pipeline, truck and ship.

The document include catalog on transport via:

1. Pipeline
2. Trucks
3. Ships

These Subsections are preceded with this introduction section that include:

1. Description of the different types of fuels and their key properties (See section *Properties & Short fluid description and Grade*)
2. Grouping fuels into (Section *Transport form – chemical phase*):
 - Liquid fuels (**LHC**)
 - Fuels that are liquefied @ 20 bar (**L20**)
 - Fuels that require extreme cooling to liquify (**H2NG**)

There exist many different fuels (see Table 1). To avoid having to treat each fuel separately, the above three fuel groups have been defined. These groups are used to identify which transport form/phase is possible/optimal and thereby which elements that are needed in the transport chain.

3. Advantages and disadvantages of different transport forms (i.e. pipeline, truck, train and ships) (Section *Transport unit – pipeline, truck, train or ship*)
4. Material of construction, i.e. steel grade needed for handling the different types of fuels (Section *Material of construction*)
5. Safety issues (Section *Safety*)
6. Overall transport chain (Section *Transport chain - logistic and infrastructure*) giving an overview of the elements that must be included in the entire transport chain
7. Energy loss - overview of different type of energy losses and how they can be predicted (Section *Energy losses*)

8. Possible elements of the transport chain:

- Conversion to/from hydrogen carrier (Section *Conversion to/from carrier (LOHC)*) (only for H₂)
- Conversion to liquid phase by cooling (Section *Convert to liquid phase by cooling*)
- Compressor (Section *Compressor*)
- Pumps (Section *Pumps*)
- Fiscal metering (Section *Fiscal metering stations*)
- Storage tanks (Section *Storage tanks*)

These sections include losses and costs for the different elements.

9. Examples (Section *Examples - full transportation chain*) of calculating loss and cost for the entire transport chain

Properties

Key properties

This chapter lists key chemical properties for fuels and some LOHC. The purpose is for later reference.

This catalogue aims to lump components into fuel groups that are treated together. Therefore, properties for other fluids than the H₂, NH₃, DME and LOHC have been included.

In Table 1, the following properties are given:

1. **Energy density:** The energy density listed is per mass. This can be converted to energy density per volume by multiplying with the density which is given too. The mass- and volume-based energy density is plotted in Figure 1.
2. **Freezing point and boiling point/distillation curve:** The freezing point gives the solidification point while the boiling point/distillation curve gives the point/range where it vaporizes. For single components (i.e. H₂, NH₃, MeOH, etc.), freezing and boiling points are single points, while for mixtures (LPG, gasoline, jet fuel, etc.) it's ranges. These properties give the chemical phase (solid, liquid, gas) that a given fuel will take at ambient pressure (1.025 bar).
3. **Flash point, autoignition point and flammability/explosion limit:** These properties are ignition and safety related properties. Flash and autoignition point give the lowest temperature at which it ignites with and without an ignition source. The explosion limit gives the fuel concentration range in air where it will burn/explode in the presence of an ignition source.

Fuel types	Fuels	Energy density - LHV (MJ/kg)	Heat of condensation (@ boiling point) (MJ/kg) (% of LHV)	Temperature, C				Flammability/Explosion limit, % (LFL/LEL) / (UFL/UEL), %	Molecular weight, kg/kmole	Density, g/l, Kg/m ³ (at Amb.) (Liquid dens. @ Pboil)	Chemical/CNO
				Freezing point	Boiling point/ Distillation curve	Flash point	Autoignition				
H ₂ /H ₂	Hydrogen	120		-259.2	-253	NA	560	4/75	2	0.0899 (70.9)	H ₂
	Ammonia	19	1.37 (7.4%)	-77.73	-33.4	132	651	15/28	17	0.73 (620/7 bar)	NH ₃
Hydrocarbon mixture	NG	47		-182	-163	-188	600	~5/16	16-18	0.76 (657)	C1
	LPG	46.6	0.43 (0.9%)	-188	-43	(-60)-(-100)	410-580	1.8/9.6	42-56	~ 2.4 (540)	C3-C4
	Petrol/benzin/ gasoline	43		<-40	30-210	-43	280	1.4/7.6	~72	~ 780	C4-C12 (typical C7-C11)
	Diesel	43		<-6	150-360	52-96	210-230	0.6/5.5	198-202	800-850	C12-C20
	Vegetable oil (HVO)	44		<-10/-40	180-320	> 55	424	4/33	~ 250	~ 780	C15-C18
	Heavy fuel oil (HFO)	39		NA	150-750	> 50, 65-80	>400	NA	mean=240, 50-1800	~ 980, >900	typical C20-C50
	Marine gasoil (MGO)	44-45		>-40	150-500	60-85	>250	1/6	200-300	850-870	<C35
	Jet-fuel (Jet A-1)	>42.8		<-47	205-300	38-66	>229	0.6/4.7	~185	775-840	C10-C13, mostly kerosene
	Kerosene	43		-47	150-275	37-72	220	0.6/4.7	~170	780-810	C6-C20 (typically C10-C16)
	Methanol	20		-97.6	65	11-12	385	6/36	31	790	CH ₃ OH
Oxy fuels	Ethanol	27		-114	78.4	16.6	363	3.3-19.0	46	789	C ₂ H ₅ OH
	Propanol (Bio-LPG)	34		-126	82	26	371	2.1/13.5	60	803	C ₃ H ₇ OH
	n-Butanol	33		-89.8	118	35	343	1.4/11.2	74	810	C ₄ H ₉ OH
	DME	29	0.47 (1.6%)	-141	-24	-41	350	3.4/27	46	2.11 (668)	C ₂ H ₆ O
	Bio-Diesel (FAME)	38		(-16)-16	340-360	173	261	NA	~ 296	~ 880	C ₁₆ -C ₂₁ , Ester
LOHC	DBT: Dibenzyltoluene			<-31.8	>250	190-210	500	NA	272	1029	C ₂₁ H ₂₀
	HDBT: Perhydro-Dibenzyltoluene			-34	~390	~200	NA	NA	291	NA	C ₂₁ H ₃₈
	FA: Formic acid	6		8.4	100.8	69	601	14/34	46	1220	CHOOH
	MET: Methanol	20		-98	65	11-12	385	6/36	31	790	CH ₃ OH
	TOP: Toluene	40.6		-95	110.6	6	480	1.1/7.1	92	867	C ₇ H ₈
	Methylcyclohexane	43.3		-126.3	101	79-87	540	0.9/5.9	98	770	C ₇ H ₁₄

Table 17: Key fuel properties.

Energy density

The energy density for various fuels are shown in Figure 1.

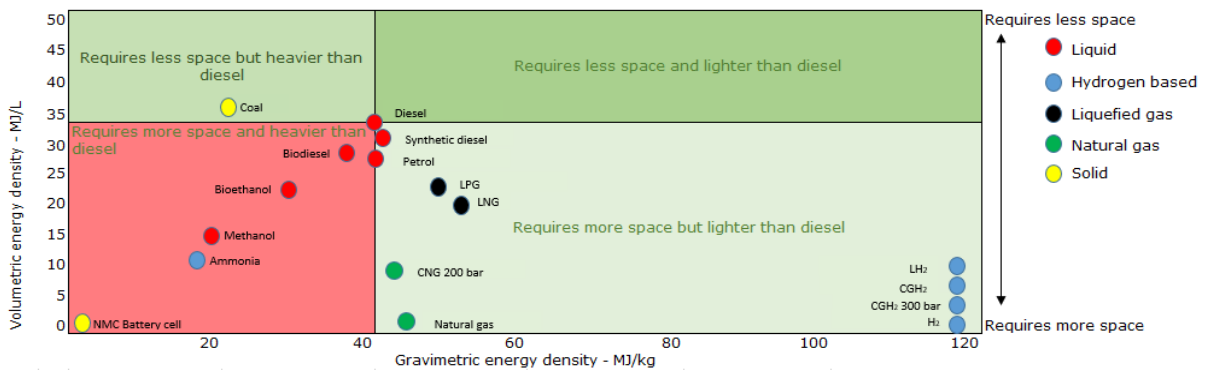

Figure 2: Energy density for various fuels

Phase curve

In Figure 2 the gas-liquid phase curve is represented for various fuels. Thus, the fuel is liquid on the left-hand side of the curve and gas on the right-hand side. The red line represents ambient condition (pressure is 1.025 bar and temperature is between -50 °C and +50 °C). This red line express which phase the fluid is if not exposed to any cooling or pressurization. At 20 bar (the purple line) the majority of fuels (all except for hydrogen, methane and ethane) are liquids.

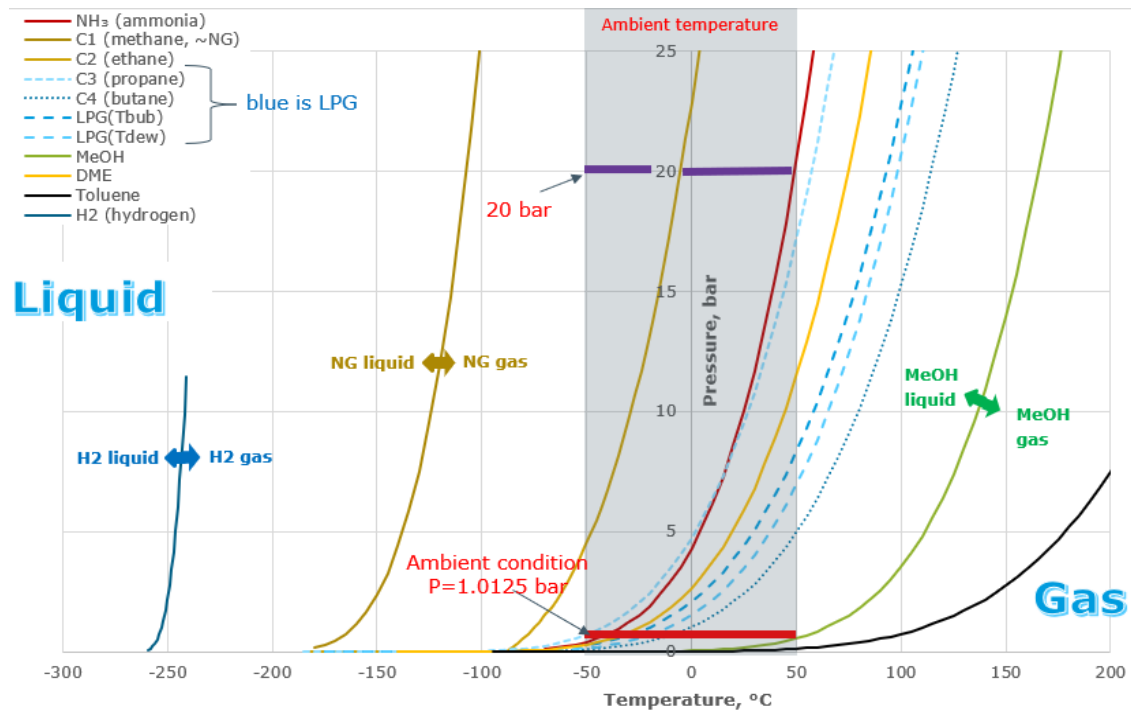

Figure 3: Phase curve for various fuels. Toluene is representative for LOHC which all are liquid at ambient condition. All hydrocarbon mixtures above C5 and all alcohols are below the MeOH curve

Short fluid description and Grade

Hydrogen (H₂)

Hydrogen is lighter than air, highly flammable, very easily ignited, does not cool when expanded, and has so small molecular size that leakage and even penetration into the surrounding material is a key design issue.

Hydrogen fuel grades – key requirements to hydrogen when used as fuel for PEM fuel cells for road vehicles (ISO 14687, SAE J2719):

1. >99.97 %
2. < 5 ppm H₂O, < 5 ppm O₂
3. Max requirements to several other impurities

Ammonia (NH₃)

Ammonia is a toxic, corrosive, less flammable gas with a strong characteristic odor. Ammonia is lighter than air but because of its tremendous affinity for water, it reacts immediately with the humidity limiting the dispersion in the environment. Is not a greenhouse gas.

Typical product specification ref. 25:

1. >99.5 wt % NH₃

2. 0.2-0.5 wt % Water
3. max 5 ppm oil

Refrigerant grade ammonia ref. 28

1. >99.95 wt % NH₃
2. < 33 ppm H₂O
3. < 2 ppm oil

Ammonia is still not approved as fuel, thus no fuel grade requirement exists yet.

Dimethyl ether (DME)

Dimethyl ether (DME, CH₃OCH₃) is colorless, non-toxic and highly flammable.

Typical product specification

- 99.7 DME
- Rest is MeOH

Transport form – chemical phase

Within this catalogue, fuels are divided into three groups (see Table 2).

Group	Description	Include	Transport form	Transport options		
				Pipeline	Truck/ train	Ship
1 LHC	Liquid @ ambient condition (see <i>Liquid fuels (LHC)</i>)	<ul style="list-style-type: none"> • HC where CNO≥5 • All alcohols • All LOHC 	Liquid P=few bars, T=Amb.	yes	yes	yes
2 L20	Liquid @ P=20 bar (see <i>Liquid at ≥ 20 bar (L20) - NH₃, DME and LPG</i>)	<ul style="list-style-type: none"> • NH₃ • LPG • DME • (Ethane) 	Pressurized Liquid P=10-30 bar, T=Amb.	yes	yes	yes
3 H2NG	Require extreme cooling to liquify (see <i>H₂ and NG</i>)	<ul style="list-style-type: none"> • H₂ • Methane/NG 	Cooled liquid P=few bars, T~ (-25)-(-45) °C	no	yes	yes
			Pressurized gas NG: P=60-80 bar, T=Amb H ₂ : P=60-140 bar, T=Amb	yes	yes	no
			Cooled liquid ² NG: P=few bars, T~-163°C H ₂ : P=few bars, T~-253°C	no	yes	yes
			Carrier (only H ₂) P=few bars, T=Amb.	yes	yes	yes

Table 18: Transport groups, which fuel belong to each group, possible transport form/phase and possible transport options

Group 1 (LHC) is liquid at ambient condition. Group 2 and 3 fuels are converted into the more energy dense transport form either via pressurization, cooling or reaction with a carrier³ (latter only relevant for H₂). The advantages and disadvantages for each of these packing methods are listed in Table 3 below.

² Might be a combination of cooling and pressurization

³ See definition/description in 1.4.3 and Table 1-4

	Pressurized	Cooled	Carrier ³ (only H ₂)
Advantages	<ol style="list-style-type: none"> 1. Low compression loss 2. Low transportation loss 	<ol style="list-style-type: none"> 1. High volumetric energy density compared with compressed gas 	<ol style="list-style-type: none"> 1. Higher volumetric energy density compared with both CH₂ and LH₂ 2. Stored at ambient condition 3. Existing infrastructure can be used 4. Neglectable transport and standby loss 5. Long term storage without loss 6. Safety – less flammable fluid
Disadvantages	<ol style="list-style-type: none"> 1. Low volumetric energy density requiring many tours if transported with trucks/ships. 2. Cost intensive as high amount of steel is required due to the high pressure (thick tank walls) 	<ol style="list-style-type: none"> 1. Capital cost of installing refrigeration/cryogenic unit 2. High conversion loss 3. Normally high loss when transferring fluid from one vessel to another (all surfaces must be kept cold) 4. Boil off (or cooling or highly isolated) under transportation/standby 	<ol style="list-style-type: none"> 1. Capital cost of installing conversion unit 2. High conversion loss 3. Extra transport fuel as weight of carrier must be transported too (both forth and back)

Table 19: Advantages and disadvantages for different methods of converting group 2+3 into more energy dense transport form.

Liquid fuels (LHC)

All fuels and LOHC that are liquids at P=1.025 bar and T=50°C will be treated as one group called liquid fuels (LHC). This group includes:

1. All hydrocarbons with carbon number (CNO) larger and equal to 5 (gasoline, diesel, HFO, MGO, Jet fuels, etc.)
2. All alcohols (Methanol, Ethanol, Propanol, etc.)
3. All liquid organic hydrogen carriers (LOHC) (see examples in Table 1)

All these fuels are stored and transported in the same manner as conventional liquid-hydrocarbons.

Liquid at ≥ 20 bar (L20) - NH₃, DME and LPG

This fuel group (L20) include fuels that are liquid at (P=20 bar, T=50°C) and vapor at (P=1.025 bar, T=50°C). All fuels within this group will all be transported and stored as liquids.

This group include NH₃, DME an LPG. Pure ethane is also part of this group but will require a little higher pressure to liquify than the others.

The liquefaction will always be via pressure when transported in pipeline while either pressurization, cooling or both can be applied when transported via truck, rail and ships.

H₂ and NG

Fuels that are gaseous at 20 bar can either be transported as compressed gas (will always be the case for pipe-transport), cryogenic liquid or via a carrier (the latter is only for H₂). Hydrogen and natural gas require cryogenic cooling for liquefaction.

Pipe transport: As cooling is impractical, H₂ and NG will always be transferred as compressed gas in transmission pipes.

Mobile transport: NG will normally be transported as a liquid. Hydrogen is today mostly transported as compressed gas but liquid transportation exist too. As hydrogen require extreme cooling, its optimal transportation (and storage) form is still under development. Figure 3 gives an overview of different ways hydrogen can be transported/storage.

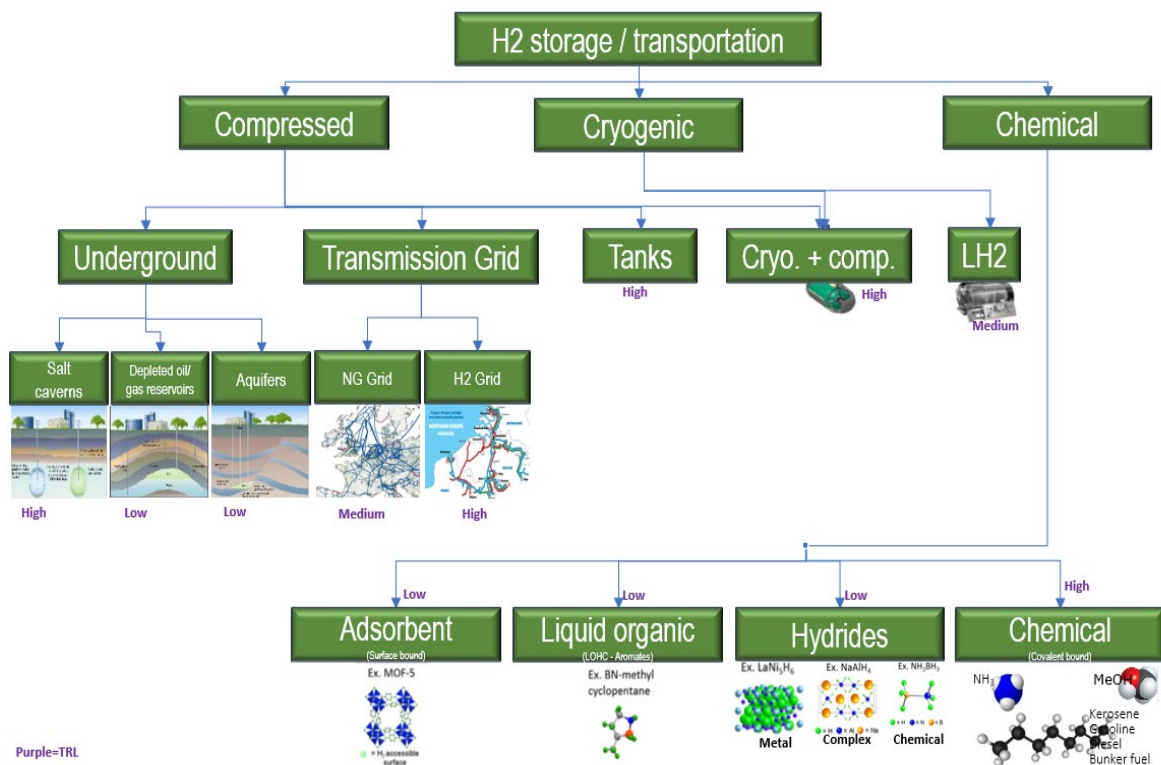

Figure 4: Different H₂ storage and transport technologies

For compressed underground and tank storage see ref. 7.

Transport of hydrogen via existing NG-grid: Today no H₂ is allowed in the Danish NG-grid. Investigation have been made [ref. 16] and it is expected that 10% hydrogen can be added with minor modifications and more (but still moderate) investment is required to allow up to 20% H₂.

The disadvantages of admitting H₂ to the existing net is that any users that need pure H₂ (or pure CH₄⁴) need to separate H₂ from CH₄ which is expensive. Normally a PSA will be applied for such separation and here the natural gas will come out at low pressure and need to be re-pressurized.

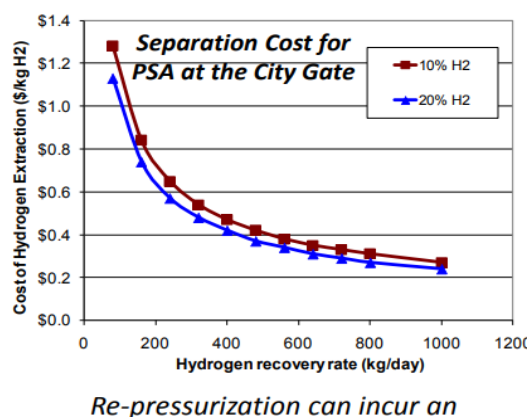

Figure 5: Separating H₂ from NG using PSA ref. 19

Liquid hydrogen require liquefaction. The energy loss under liquefaction process is very high (see *Cryogenic Liquefaction of H2*) meaning that LH2 only is optimal for very long-distance transport.

Hydrogen carriers are substances that are able to bind several hydrogen atoms. As hydrogen is more expensive to store/transport than other fuels, extensive research has lately been carried out to investigate whether hydrogen carriers are optimal for storage and transportation of hydrogen.

Different types of hydrogen carriers are listed in Table 4 together with their advantages/disadvantages.

	Description	Component (examples)	TRL	Advantages	Disadvantages
Adsorbent	Solid that adsorb hydrogen on the surface or in the pores of complex materials via intermolecular forces.	Metal-organic frameworks (MOFs), graphene, carbon nanotubes	1	Materials can be reused many times Stable materials	Immature technology
Ion hydrides	Compounds consisting of hydride ions (H ⁻) and electropositive metals, typically an alkali or alkaline earth metal	LiH, NaH, KH, MgH	2	Flexible source of hydrogen Can be stored infinite under dry conditions	Must not be exposed to any moist before the dehydration, pyrophoric Dehydrogenation is strongly exothermic => waste heat
Covalent metal hydrides	The hydride is part of complex ions, where hydride is covalent bound to a metal atom	LiBH ₄ , NaBH ₄ , LiAlH ₄ , NH ₄ BH ₄	2	More stable than ion hydrides	Highly alkaline waste after hydrogen release
Metallic hydrides	Hydride is nonstoichiometric bound/adsorbed/absorbed to precious metals and its alloys. Hydrogen is released by heating	Precious metals (Pd, Pt)	2	Knowledge available from the Ni-Hydrogen battery technology	High cost as currently made in small quantities and as require >95% purity
Liquid Organic hydrocarbons	Liquid organic hydrogen carriers are organic chemical components that relatively easy can be hydrogenated/dehydrogenated.	See Table 1 and ref. 7	7	Transported and handled as liquid fuel are handled today	Many different technologies for releasing hydrogen
H ₂ rich chemical	Non carbon-based compounds that relatively easy can be hydrogenated/dehydrogenated.	NH ₃ , hydrazine	4-8	Except for the cracking into H ₂ , mature technology ready for large scale exploration	Toxic Untested as hydrogen supply Very high cracking temperature required NH ₃ is poison to PEM fuel cell, i.e. no NH ₃ traces after cracking

Table 20: Different type of hydrogen carriers

⁴ Most of todays gas-turbines cannot take larger amount of hydrogen.

Liquid organic hydrocarbons (LOHC) and hydrogen rich chemicals are all transported as liquids (thus covered by LHC in this catalogue). Adsorbent, ion hydrides and covalent metal hydrides are solids and need special transportation which is not included in this catalogue.

Transport unit – pipeline, truck, train or ship

Ways to transport fluid are listed in Table 5 together with key advantages/disadvantages.

	Advantages	Disadvantages
Pipeline	<ul style="list-style-type: none"> • Limit number of intermediate storage/compression stages (Table 8). • Combine transport and storage • Very low OPEX • Very low risk • Can transport large amount of energy much cheaper than electric cables • Provide point to point solutions, i.e. limit number of intermediate storage/compression stages 	<ul style="list-style-type: none"> • High CAPEX • Less flexible than mobile transportation
Trucks		<ul style="list-style-type: none"> • Risk is higher than pipeline, train and ships • Size limited to max weight, width and length of a truck
Trains	<ul style="list-style-type: none"> • Risk are lower than trucks but higher than pipelines 	<ul style="list-style-type: none"> • No point to point solution – needs other transportation form in both ends • Size limited to max weight, with and length of train carriage
Ships	<ul style="list-style-type: none"> • Less fuel consumption per distance: ship ~0,3 MJ/ton/km, train ~0,6 MJ/ton/km, road ~1.2 MJ/ton/km. Reason is less friction loss due to buoyancy forces.⁵ • Size limitation: much larger amount can be transported per trip than on trucks and trains • Social risk (the amount of people that can die if an accident occurs) is much less offshore than onshore (see Safety) • Cheapest option for very long distances 	<ul style="list-style-type: none"> • No point to point solution – needs other transportation form in both ends

Table 21: Ways to transport major amount of fluids and associated advantages/disadvantages

Overall:

- 1 Truck: optimal for low capacity, short distance, onshore transport
- 2 Train: optimal for long distance, through desert areas without intermediate consumers, and where onshore route is much shorter than offshore (i.e. across US, Russia and Australia)
- 3 Ship: optimal for long distance where a valid offshore route exists
- 4 Pipeline: optimal when larger quantities and/or many consumers

Below a catalogue for pipeline (chapter 0), truck (chapter 0) and ships (chapter 0) are given. Train have been excluded as other transportation forms are normally more optimal in Europe due to either short distance, many intermediate consumers and lot of coastline. An exception is ammonia which is transported via rail from Russia to Europe [ref. 25].



Figure 6: Train transporting NH3 from Russia to Europe.

⁵ Energy Efficiency of different modes of transportation, James Strickland, 2006

Material of construction

Hydrogen (H₂)

Hydrogen embrittlement is cracking associated with hydrogen penetration into the metal grid. At low pressure (<150 bar), hydrogen is only able to enter materials in the form of atoms or hydrogen ions. Thus, pure gaseous hydrogen is not absorbed by materials at ambient temperatures, as it is in molecular form. However, dissociation of hydrogen into H-atoms can occur due to (point 2-4 can occur at temperature below 150°C):

1. High temperature⁶ (>150°C, very little <200°C) [ref. 27]
2. Surface irregularities (impurities in the hydrogen and at the surface)
3. Corrosion
4. Electrochemical or chemical surface treatment
5. Cathodic protection

Any penetration of H-atoms into the metal grid may lead to hydrogen embrittlement when temperature is below ~150°C.

Hydrogen embrittlement can only occur in combination of the following three factors:

1. A susceptible material
2. Hydrogen environment (H⁺-ion formation – see points above)
3. High tensile stresses

Thus, if stresses are sufficiently low, the environment not sufficiently aggressive, or the material not susceptible, the hydrogen will diffuse through the material without causing damage.

Susceptible material: ASME B31.12 specify material requirements to hydrogen pipes⁷ and material grades that are approved for hydrogen pipes. For design pressures (Pd) <200 barg and design temperatures (Td) <175°C Carbon steel (A 105/A 106) and Micro alloy steel (X42 and X52) is applicable.

⁶ Material is normally exposed to hydrogen at high temperature under manufactures (casting, carbonization, coating, plating, cleaning, pickling, electroplating, electrochemical machining, welding, roll forming and heat treatment).

⁷ The key material requirements are also listed in ref. 5 and 1.

For Pd>200, high alloy steel (SS-316L) should be used [ref. 6]. X70 may be used subject to evaluation of the hardnability in weld heat affected zones. Within this catalogue, X52 have been used.

High tensile stresses: The stress levels can be lowered by:

1. Closer pipe support
2. Thicker pipe walls
3. Thermal relieving residual welding stresses
4. Hydrotesting (autofrettage)

Ammonia (NH₃)

Ammonia is corrosive to:

1. Copper
2. Copper alloys
3. Zinc
4. Nickel (must be kept below 5 wt%)
5. Most plastic

Oxygen levels of more than a few ppm in liquid ammonia can promote stress corrosion cracking especially at high temperatures. Ammonia and oxygen induced SCC are not expected at ambient temperatures, but stresses caused by welding can initiate SCC if oxygen is present. Ammonia as produced contains no oxygen. However, when filled into a tank, it must be ensured that the tank is purged until <0.5% oxygen before NH₃ is admitted.

Water content in ammonia should be > 0.1 wt %. Research have shown [ref. 8] that presence of water inhibit the formation and growth of SCC (see grade specification under *Ammonia (NH₃)*).

Non-ferrous alloys are resistant to ammonia. Minimum requirement for stress yield strength and post-welding treatment are given in IGC Code chapter 17.12. The code also describe how ammonia stress corrosion cracking is avoided.

Steel piping are suitable for ammonia gas and liquid. Within this catalogue X52 have been applied.

Dimethyl ether (DME)

Steel piping are suitable for dimethyl ether. Within this catalogue X52 have been applied.

Liquid fuels (LHC)

Steel piping are suitable for most LHC. Within this catalogue X52 have been applied.

Safety

Key safety parameters are listed in Table 6. All fuels are flammable with H₂ being the most flammable/explosive. NH₃ do also have toxicity impact (see section *Ammonia (NH₃)*).

Table 22: Key safety parameters

		H ₂	NH ₃	DME	LHC/Toluene
Toxicity		None	See <i>Ammonia (NH₃)</i>	None	Depend on chemical. Liquid, i.e. leakage do not lead to inhalation.
Flammability/Explosion limit ⁸ , %	Lower (LFL/LEL), Upper (UFL/UEL)	4 75	15 28	3.4 27	1.1 7.1
Flame		Very difficult to see	Yellow	Blue	Most white + yellow
Flash point, C		NA	11	-24	≥6
Auto ignition point, C		560	651	235	200-500
Ignition energy, mJ		0.017	680	0.29	>0.2, most ~0.25
Detection limit air		25 ppm	5-50 ppm (smell), ~1 ppm	-	-

For every system the risk (= probability × severity of consequence) must be quantified. If risk violate acceptance criteria, measures to eliminate, reduce the probability and/or consequence must be taken.

Collision

The probability for collision between mobile transport depend strongly on where the transport is carried out. Generally, the likelihood for collision is much higher in populated areas, i.e. in cities, on train stations or in harbours. Additionally, the likelihood for collision on road is much more likely than collision with train or ships. Contradictory, if a collision occurs, then probability of tank rupture, and leak of large amount, is much higher from thin walled tank that carry cooled liquid (which is the most common liquefaction method on ships) than for thick walled tank that carry pressurized liquid [ref. 13].

Loading/unloading

Due to the nature of fuels, loading (and unloading) are very critical process that must be executed with utmost safety precautions. Any leakage is critical.

It must be ensured that all loading systems/tanks are emptied for oxygen before exposed to fuels. Any purge with inert gas to remove oxygen must subsequently be vented to prevent contamination of fuel with inert gas. Tank-purge can be avoided if tank is only used for one fluid type and the tank is kept at slightly overpressure to prevent ingress of air. This is common for CH₂ tube trailer tanks.

If loaded with refrigerated/cryogenic liquid, the loading system/tanks must either be pre-cooled or loading must be slow to prevent uncontrolled pressure rises and unsafe temperature gradients. Due to the sub-zero boiling points at atmospheric pressure of LPG, NH₃, DME and H₂, the refrigerated liquids that are entering tanks and piping which are at ambient temperature and pressure immediately begin to boil. Boiling and evaporation will continue until the materials reaches the liquid temperature. This initial boiling will cause a rapid pressure increase in the loading system. The pressure attained will depend on the quantity of liquid and the heat available for evaporation. Care should therefore be taken

⁸ Gas to air ratio

to introduce liquid into non-cooled tanks sufficiently slowly to avoid an uncontrolled pressure rise. The initial boiling will also cause local cooling of the tank structure, with the risk of thermal stresses of the materials. Spray cooling⁹ is essential for very cold cargoes.

Leakage

Pipeline is the safest mode of transporting of fluid fuels. Long-distance pipelines must fulfill high demands of safety, reliability and efficiency. If properly maintained, pipelines can last indefinitely without leaks. Significant leaks that occur are normally caused by damage from nearby excavation or by corrosion caused by incorrect operation.

Pipeline is normally equipped with some leakage detection system. Leakage detection system can include:

1. Internally leakage detection systems:

- 1.1. Sensors and computer system that via a series of pressure and flow rate sensors and mathematical models estimate whether leakage occur
- 1.2. Acoustic pressure waves measures

2. External leakage detection systems: Infrared radiometers, thermal cameras (above ground only), gas detectors, acoustic sensors, and digital oil leak detection cable

3. Odor addition: see section [Odorization](#)

In case a leakage is detected, insulation valves and associated vents are installed frequently (for every 10-20 km) so the leakage can be isolated, vented and repaired without having to empty the entire pipeline.

Sectionalization

Pipelines and larger transportation tanks are sectionalized (pipes with ESD valves that are closed in case of an emergency) to mitigate the risk of very large leakages, fires and explosion.

Hydrogen (H₂)

Due to the low flash point, low ignition energy and wide flammability range, the probability that hydrogen ignites immediately is very high. For cryogenic liquefied H₂, burning is also a risk.

Monday June 10, 2019, a hydrogen gas filling station at Kjørbo (near Oslo) in Norway caught fire and exploded. Three people were treated for minor injuries due to airbags deploying in their car nearby. The fire caused severe damage on the filling station. A root cause analysis by the authorities, Nel and Gexcon has identified the cause to be an assembly error of a specific plug in a hydrogen tank in the high-pressure storage unit. Due to human error, the inner bolts of the plug had not been adequately torqued. This led to a hydrogen leak, which created a mixture of hydrogen and air that self-ignited, which created an explosion (pressure wave) and the fire.

⁹ Cargo tanks are cooled down by spraying the initial loaded fuel (LNG) through spray nozzles

Ammonia (NH₃)

The major safety concern related to ammonia is its toxicity issues are:

Conc. ppm	Exposure period	General effect
5-50	Max 8 h	Odor, detectable by most persons, Mild discomfort
50-80	2 hours Exposure for longer periods not permitted	Perceptible eye and throat,
100		Nuisance eye and throat irritation
140	2 hours	Serve irritation, need to leave exposure area
134	5 min	Tearing of eyes, eye-, nasal-, throat- and chest irritation
500	30 min	Upper respiratory tract irritation
700	<1 h	No serious injuries and repeated exposure produce no chronic effect
700-1700	Can be fatal after 30 min	Convulsive coughing, Severe eye, nose and throat irritation,
5000-2000	Can be fatal after 15 min	Incapacitation from tearing of eyes
5000-10000	Rapidly fatal (within min)	Respiratory spasm, Rapid asphyxia
>10000	Promptly lethal	

Table 23: Ammonia toxicity exposure levels ref. 14, 25 and 8.

As ammonia is a toxic gas, it must be transported according to local legislation which normally means requirements to general safety procedures concerning:

1. Leakages
2. Minimum allowable cargo tank steel temperature
3. Firefighting and emergency procedures
4. Training of personal - driver/crew must complete specific training

Safety measures for handling ammonia include:

1. Protective full body chemical protective clothes, goggles/face shield, gloves and safety footwear
2. 5 gallons of water (first aid if skin or eyes are exposed) and breathing apparatus



Figure 7: NH₃ leakage - Panaji

Ammonia pose some challenges to ensure safety of the crew on ships as personal cannot escape. Thus, any leakage can be fatal why piping and vessels normally are double walled with leakage detectors between the double wall.

Odorization

Odorant (normally tetrahydrothiophene (THT) or mercaptan) is added to the NG distribution net and partly to the NG transmission net, allowing leaking gases to be detected before it reaches combustible levels. The disadvantages with odorants are:

1. Human must be present in the vicinity of the leak and not all are able to detect the odors at the mandatory level
2. Commercial odorants are poisons for catalyst used in most synthesis and in hydrogen-based fuel cells. Thus, cost of removing odors will be high

Due to these disadvantages and as it is assumed that the hydrogen net mainly will be a transmission net (and not a distribution net in densely populated areas), odorization is not recommended as a safety solution and will not be included in the performance and cost evaluation of hydrogen transmission piping.

Transport chain - logistic and infrastructure

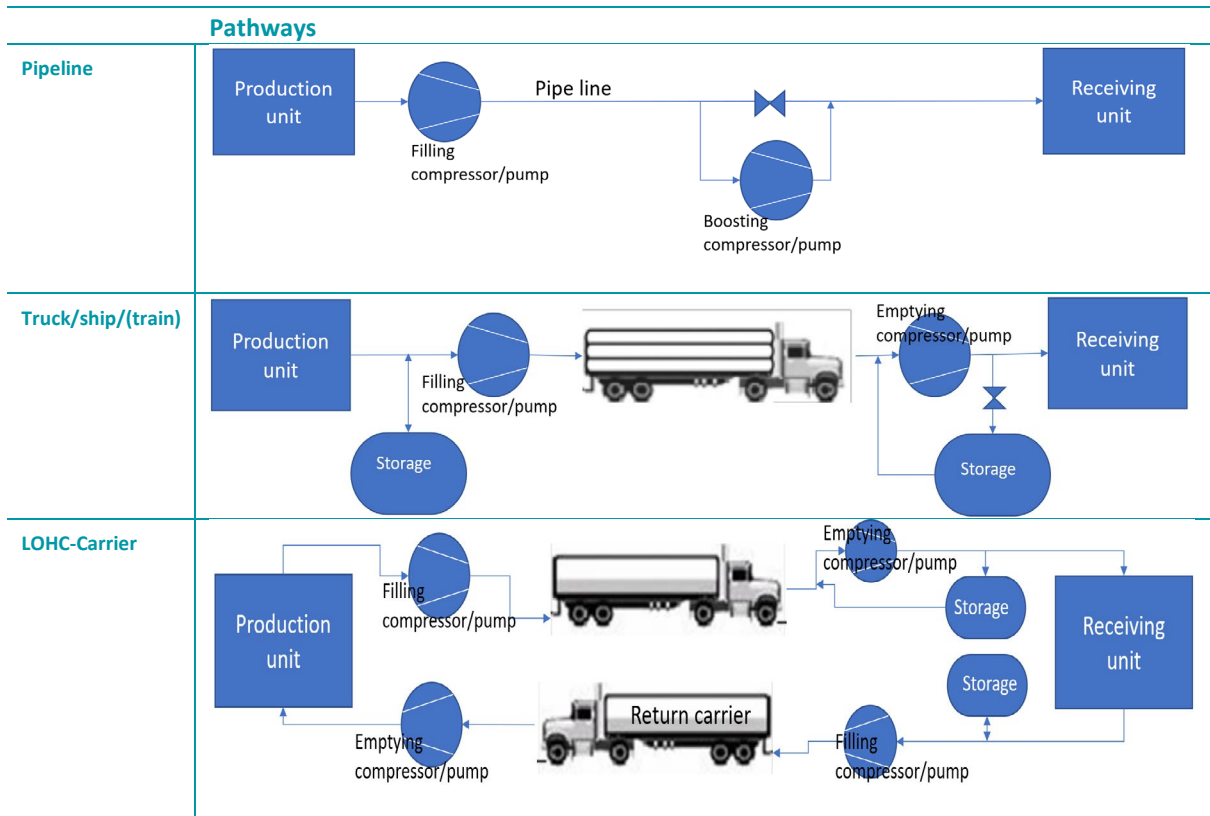

Table 24: Infrastructure for the different transportation solutions

Table 8 give overall units need for the different transport method.

While filling compressor/pumps are used to transfer the fuel from the production unit to the transportation unit, emptying compressor/pump is used to transfer the fuel from the transport unit to the receiving unit. Emptying compressors/pumps may for liquid fuels be replaced with gravity (see Figure 20).

Pipeline: Key elements are the pipeline, filling and boosting pressurization units (see detail description in *Elements in pipe transmission net*). Boosting compressor is compressor/pump substations along the pipeline that boost the pressure to compensate for pressure drop along the pipeline.

Truck, ship, train: Key elements are the transportation unit (truck, train or ship), filling and emptying compressor/pump and storage tank in each end.

LOCH-carrier: Same key elements as above except that the carrier must be transported back again if not used at the receiving unit. The production unit include the conversion to carrier and liquefaction by cooling.

Whether additionally storage and compression/pumping facilities are needed will depend on the actual design. However, when design an infrastructure, it is important to notify that transfer of gas or liquefied fuel from one vessel to another inherit the following losses:

1. **Compression/pumping losses:** Especially compression is complex and can inherit larger losses as the pressure drops on the suction side, and increase on the discharge side, while emptying and filling the vessels.
2. **Cooling losses:** need to cool down the material of the new storage vessel

To limit these losses, it is optimal to limit the number of vessels in the infrastructure. Thus, it should be considered whether the storage and transportation tank could be the same vessel.



Figure 8: Hydrogen storage, transportation and fuel tank.

Section *Energy losses* gives an overview of the various sources of energy losses. Sections *Conversion to/from carrier (LOHC)* to *Storage tanks* describe the units within the transport chain and section *Examples - full transportation chain* gives some overall loss and cost calculation examples.

Energy losses

Depending on transport phase (gas or liquid) and transport unit (pipeline, truck, train or ships), the energy losses may include:

1. **Conversion to/from a carrier** (only for hydrogen) (see *Conversion to/from carrier (LOHC)*)
2. **Cooling losses** – losses in conversion to liquid phase via cooling
 - 2.1. Refrigeration of NH₃, LPG and DME (see *Refrigeration of NH₃, LPG and DME*)
 - 2.2. Cryogenic liquefaction of NG and H₂ (see *Cryogenic Liquefaction of NG* and *Cryogenic Liquefaction of H₂*)
3. **Pressurization losses** – shaft power and interstage cooling losses within filling, boosting and emptying compressors/pumps
 - 3.1. Compression losses (for CNG and CH₂) (see *Energy loss – reciprocating H₂ compressor*)
 - 3.2. Pumping losses (for LH₃, LPG, LDME, LNG, LH₂) (see *Pumps*)
4. **Fuel for propulsion** (for truck, train and ships): Fuel consumption depends on weight due to increased resistance and increased force needed when accelerating.

Trucks:

Vehicles EU 2018	LoadFactor _{weight} %	Traffic data*	
		Energy _{wtw} [MJ/km]	CO ₂ e _{wtw} [g/km]
Truck with trailer 50-60 t	0%	11,0	763
Default	50%	18,7	1279
	100%	25,0	1706

Table 25: Fuel consumption - ref. 18

As a truck is full one way and empty the other way, 19 MJ/km is used as average (19 MJ/km is ~50% load). For CH₂, the fuel is carried in thick walled tubes, and for LH₂, the fuel is carried in a double walled tank. Thus, for CH₂ and LH₂, 24 MJ/km have been used as an average as the fuel-tanks have a higher weight why the transported fuel per truck is lower.

Ships: The fuel consumption per day of a ship can be described by the Barras formula¹⁰:

$$\text{Fuel consumption/day} = \frac{W^{2/3} \times v^3}{F_c}$$

¹⁰ Barras (2004): Ship Design and Performance for Masters and Mates

Where

W=ship's displacement (total weight) in tons

v= ship's speed in knots (typically between 12-14 knots)

Fc= Fuel coefficient (Fc=120.000 for diesel engine)

As ships displacement is not always given, the following approximation has been made based on average from various sources (valid if velocity ~13 knots):

$$\text{Fuel [MJ/km]} = 0.023 \times M_{\text{cargo}} + 1400$$

Equation 1

Where M_{cargo} is the weight of the transported fuel in tons. Normally a tanker is empty on the return route, meaning that the fuel consumption for propulsion is approximately half of the delivery trip.

5. **Heat interaction with the surroundings** - Boil-off (for cooled liquids)

If the temperature of the transported fuel is different from ambient, there will be some minor losses due to heat-interaction with the surrounding. Thus, if the fuel transported is colder than ambient, energy need to be added to keep it cold. If not, some vaporization/boil-off will occur. Typically, boil-off rate (BOR) from double walled vessels with vacuum between are:

- LH2: 2-3 %/day for small portable H₂ containers and down to 0.06%/day for large. Typical boil-off is ~0.1/day [ref. 18]
- LNG: Typical 0.15-0.6 %/day on ships

This boil-off loss can be minimized if the mobile unit is using the boil-off for fuel. Thus, under the transportation the boiloff can be eliminated but not when the transportation stops.

6. **Leakage:** Leakage is assumed negligible

7. **Heating before depressurization** (only for CNG): On NG transmission pipes, there is additional losses associated with depressurization as NG must be heated before depressurized. For hydrogen, heating before depressurization is not needed as hydrogen do not cool upon depressurization when >-150 °C.

8. **Odor removal** (only for CNG): Odor is often added to NG net. Thus, losses are associated with removing the odor. As per discussion in section *Odorization*, odor is not considered for hydrogen transmission pipes

Conversion to/from carrier (LOHC)

LOHC (liquid organic hydrogen carrier) are organic hydrocarbon liquids with hydrogen "adsorbing" capabilities (see description in Table 4).

Conversion and reconversion losses today are 30-40 %. Theoretical possible is 18% and potential obtainable minimum loss is 25% [ref. 7].

Convert to liquid phase by cooling

Figure 8 gives an illustration of the steps and losses involved in conversion and transportation as liquefied fuel. The losses in liquefaction can in principle be recovered. However, as the liquefaction and regasification will be at two different locations, the calories extracted from the liquefaction will normally be loss.

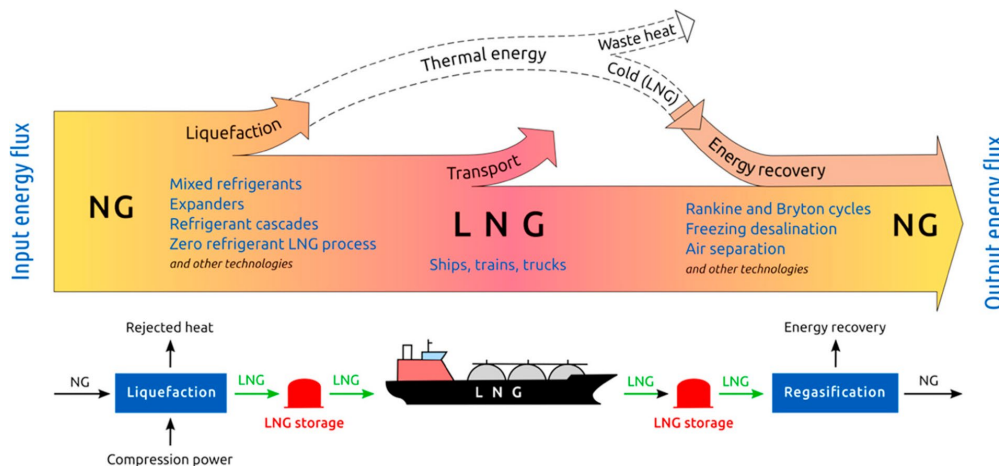

Figure 9: Illustration of steps and losses in transport of LNG. The other liquefied fuels include the same steps [ref. 11]

Refrigeration of NH₃, LPG and DME

The energy removed by the liquefaction is the energy required to cool to boiling point plus the energy required for condensation. For NH₃, LPG and DME, the energy removed by the condensation is the dominating term. Thus, an estimate for the energy removed by the refrigeration (i.e. the % energy loss associated with refrigeration) is given in Table 1. I.e. for ammonia it is ~7.4 % of the LHV, while for LPG it is ~0.9% and for DME is ~0.47 % of the LHV.

NH₃ and DME are normally produced as cooled liquids why this step is not needed.

Cryogenic Liquefaction of NG

According to ref. 10, the energy loss associated with liquefaction of NG is between 4-7%.

Cryogenic Liquefaction of H₂

The loss in the liquefaction process is between 25-45%, strongly depend on the capacity of the plant (see Figure 9). The theoretical possible minimum loss is 18% [ref. 22]

Hydrogen exist in two forms. At very low temperature it is para- H₂ while at ambient ~75% is ortho- H₂. The transition from ortho to para is very slow and releases significant amount of heat (527 kJ/kg) [ref. 18]. Thus, liquefaction of hydrogen, i.e. transferring H₂ (mainly ortho- H₂) to LH₂ (para- H₂) must be done over a catalyst ensuring all is para- H₂ before transportation/storage of LH₂. If not, 30% of the hydrogen will boil off within two days if stored in full cryogenic tank.

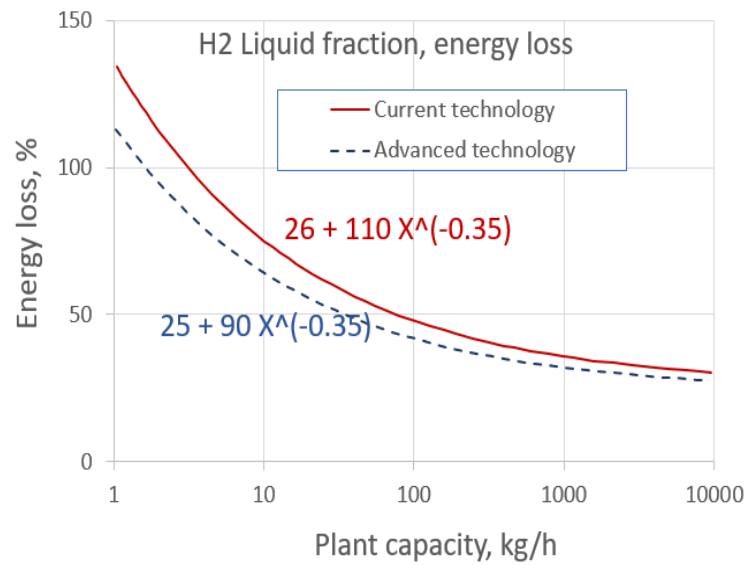

Figure 10: Energy loss associated with liquefaction of H₂ [ref.19]

Compressor

Only H₂ compressors are covered within this catalogue.

Types - hydrogen compressors

High grade hydrogen is normally a requirement. Thus, non-lubricated compressor is required to avoid oil contamination in the hydrogen.

Reciprocating/piston compressors are optimal when requiring high compression ratio (and/or having low flow and large flow variations). Thus, reciprocation compressor is optimal in most hydrogen services and will therefore be the only one considered in the performance and cost estimate.

Of reciprocating compressors, the following types exist:

1. Metal piston (free or crankshaft piston)
2. Diaphragm piston
3. Ionic liquid piston (do not require lubrication)

Future alternatives to reciprocating compressors may be the ones listed in Table 10.

Compressor type	Description
Hydride Compressor	Compressors where H ₂ is adsorbed by a hydride at ambient conditions. The absorbent is then blocked in and heated whereby the pressure will increase. Compression ratio >20 and final pressure > 1000 bar is possible. However, the product will be a hydrogen flow at high temperature which is inappropriate for transportation. It has a low TRL but may be optimal in the following cases: <ul style="list-style-type: none"> • H₂ need to be extracted from an impure H₂ rich stream • H₂ is needed at high temperature
Electrochemical hydrogen Compressor (EHC)	EHC is a compressor where the hydrogen is supplied at low pressure at the anode and via electricity is forced through a proton exchange membrane (PEM) to the high-pressure cathode side. EHC are noiseless, scalable and with energy efficiency of >80%. TRL=3-5. 

Table 26: Hydrogen compressors under development

Energy loss – reciprocating H₂ compressor

Energy loss associated with compression include shaft power and power used to operate the cooling system of the interstage coolers.

Shaft power required for compression are given in Figure 10:

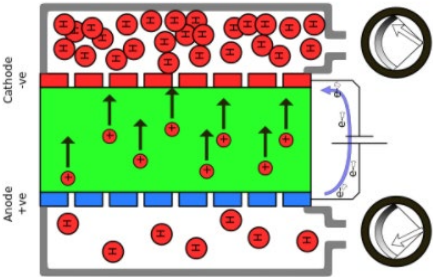
1. Adiabatic compression (blue curve): Have no interstage cooling – represent maximum losses
2. Isothermal compression (green curve¹¹): Have infinity number of interstage cooling – represent minimum losses, i.e. the ideal compressor

¹¹ The two green curves calculate the same but with different thermodynamic model (ideal gas law and Viral equation of state) where the stipulate is more accurate

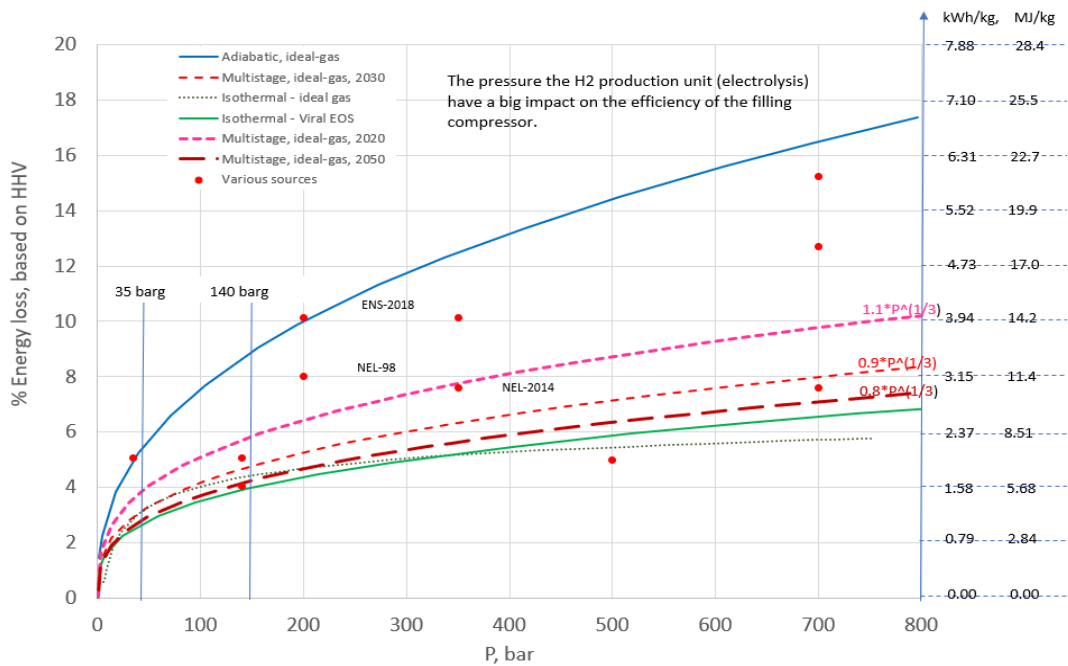

Figure 11: Energy loss for adiabatic, multistage with interstage cooling and isothermal compression (reciprocating H2 compressors). Points from various sources have been added. Numbers along the secondary y-axis are absolute loss.

Most hydrogen compressors are multistage compressors with interstage cooling. Thus, the red curves are used in the performance calculation within this catalogue (the pink is assumed today status, the red is 2030 and the dark red is 2050).

In addition to the shaft power, power used to operate the cooling system must be added too. This usually include pump loss which is very minor compared with the shaft power.

The following formula is used in this catalogue to calculate compression power loss (Pin=suction pressure [bar], Pout=discharge pressure [bar], A=1.1 in 2020, 0.9 in 2030 and 0.8 in 2050 as per Figure 10):

$$Loss (\%) = A \times \left(P_{out}^{\frac{1}{3}} - P_{in}^{\frac{1}{3}} \right), \text{ see figure above for value of } A$$

$$Loss (kWh/kgH2) = \frac{Loss (\%)}{100} \times 39.42 \frac{kWh}{kgH2}$$

Calculation example		
Pin, bar	35	Suction/inlet pressure
Pout, bar	140	Discharge/outlet pressure
A-factor	1.1	A=1.1 (2020), 0.9 (2030), 0.8 (2050)
Loss %	2.1	=A*(Pout ^{1/3} -Pin ^{1/3})
Loss, kWh/kg	0.8	=Loss%/100%*39.42 kWh/kgH2
Loss, MJ/kg	3.0	=LosskWh/kg*3.6

Table 27: Calculate compression loss compressing H2 gas from 35 bar to 140 bar

As per Figure 10, the compressor operation cost can be lowered substantially by:

1. **Increasing the suction pressure:** Increasing the pressure in the H₂ production unit (electrolysis) will have a huge impact on lowering the operation cost of the compressor as the first steep part of the curve will be cut off
2. **Increasing the number of stages:** Increasing the number of compression stages, and thereby approach the isothermal operation (green line in in Figure 10) will increase the compressor-efficiency. Additionally, multistage pressure level will also enable optimization with respect to the discharge pressure such that gas is only compressed to the current discharge pressure (the discharge pressure will be increasing when filling a tank on a truck/ship and will vary if using pipe-net as buffer/storage)

Cost – hydrogen compressors

Internal tool has been used for cost estimation of compressors. Estimated cost of filling (35-140 bar) and booster (40-140 bar) compressor is given in Figure 14.

Pumps

Internal tool has been used for cost and efficiency estimation of pumps.

Fiscal metering stations

For transmission piping, normally two fiscal metering stations (one redundant ensuring correct measure) with associating lab/sample station will be installed at all filling stations. The cost of fiscal metering station and associated lab depends strongly on how the fluid is produced, i.e. which impurities should be detected, and have been judged outside the scope of this catalog.

Storage tanks

Storage will be in steel or fiberglass (later for hydrogen) tanks. Optimally the shape is spherical (gives largest wall strength per thickness and less heat exchange with surrounding per volume stored). However, as spherical shape takes up more space, cylinder shape is often applied, especially for hydrogen storage.

In Table 12, typically storage form is given for H₂, NH₃, DME and LPG. CAPEX for storage pressurized (up to 20 bar) and refrigerated tanks (down to -33 °C) is given too.





	Pressurized storage	Pressurized and cooled storage	Cooled storage
H ₂	<p>P=165–550 bar, T=Amb.</p> <p>Thick walled metallic (Type I) or composite reinforced tank (Type II, II, IV)</p> <p>See cost and further description in ref. 7</p> 	 <p>Red is CH₂, Blue is LH₂ and green is a combination of the two.</p>	<p>T=-253°C, P≤3.5 bar</p> 
NH ₃ , DME, LPG	<p><100 ton, T=Amb., P≥20 bar</p> 	<p>100-1000 ton, T=0°C, few bars</p> 	<p>>10000 ton, up to 40000 t T=-33 °C, P=atm.</p> 
	<p>Cost, pressurized tanks, P ~ 20 bar</p>  <p>Diameter/Length ratio = 3.5 is used Might not always be the optimal ratio Typically installation cost factor ~ 5 - 6</p>	<p>Costs refrigerated tanks, P ~ ambient</p> 	

Table 28: Typical storage form vs fuel and transport phase

Examples - full transportation chain

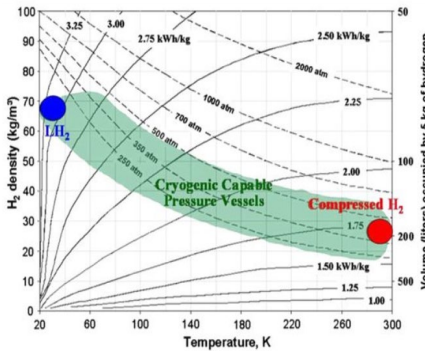
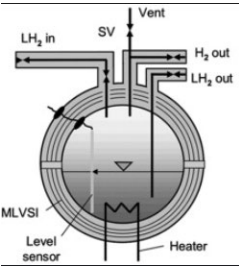
This chapter provide examples where the transport loss and the cost is calculated.

Color codes for all the calculation examples are:

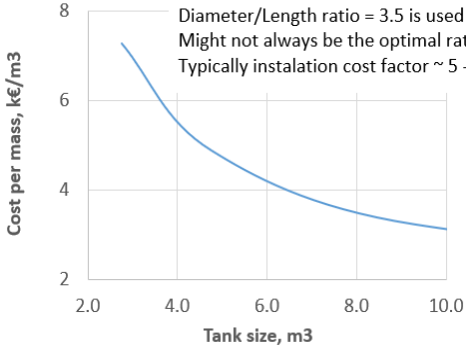
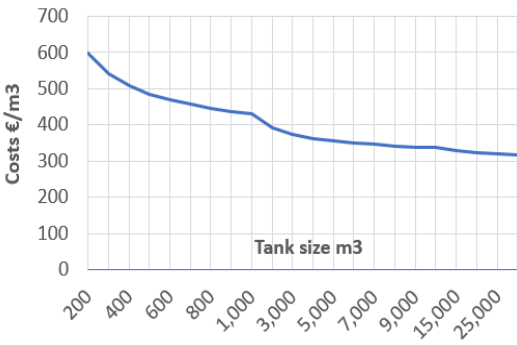
1. blue=input
2. red=numbers obtained from this document either from datasheet or given formulas
3. green= numbers obtained from internal cost estimation program
4. black = calculated values

Pipeline – CH2 calculation example

Pipeline - CH2	Fixed O&M - % of CAPEX:	4	WACC, %	5	Power/fuel input				CAPEX			life-	CAPEX +	O&M			Tot. Cost			
Fuel:	CH2	HHV=	142	MJ/kg					k€	€	M€	time	Fixed O&M	€	€	k€/y	k€/y	Transport velocity, m/s	7.0	
Transport distance:	100	km										y	k€/y	t	km ³ /t	k€/y	Transport time, h	52		
Transport capacity:	100	MW HHV	%	1000km	MW	GJ/t	€/t	k€/y	MW	km ³ /MW	y	k€/y	t	km ³ /t	k€/y		Mass flow, TPD	61		
Filling compression, Pin=35 -> Pout=140 bar, A=1.1			2.1		2.1	3.0	33	733	48		4.8	20	402				1135	Energy flow, MW HHV	100	
Metering + Scraper trap									5.2		5.2	20	434				434	Transported per y, TPA	22224	
Pipeline (Pipe + Booster comp. + Isolation stations)			7.5		0.8	1.1	11.8	261	2559		26	50	1458				1719	Power cost, €/GJ	11	
Total					4						36		2294				3288			
																	€/t	148		

Table 29: Calculation example - Pipeline CH2 - small pipe

This example shows the cost and losses associated with a small 100 km pipeline for transporting 100 MW H₂ (could be a branch off pipe to a fueling station). The example is comparable with the example in section *Truck – CH2 calculation example*, where truck transport of the same capacity is calculated.

The red numbers are obtained as follows:

1. Filling compression loss (=2.1% of MW H₂): See calculation in Table 11.
2. Booster compressor loss (=7.5 % of MW H₂), CAPEX for filling compressor (=48 k€/MW), CAPEX of metering an scraper trap (=5.2 M€) and CAPEX for pipeline (=2559 €/(km*MW)) are all from appropriate formulas in Figure 14.
3. Velocity (=7.0 m/s) is obtained from formula given in Table 19

The transport chain does not incorporate any storage. Optimally, storage can be avoided but, in most cases, it might be added. In such case, the capacity will depend on the various demands why it is omitted.

Pipeline – CH2 calculation example

Pipeline - CH2	Fixed O&M - % of CAPEX:	4	WACC, %	5	Power/fuel input				CAPEX			life-	CAPEX +	O&M			Tot. Cost			
Fuel:	CH2	HHV=	142	MJ/kg					k€	€	M€	time	Fixed O&M	€	€	k€/y	k€/y	Transport velocity, m/s	10.1	
Transport distance:	500	km										y	k€/y	t	km ³ /t	k€/y	Transport time, h	178		
Transport capacity:	4000	MW HHV	%		MW	GJ/t	€/t	k€/y	MW	km ³ /MW	y	k€/y	t	km ³ /t	k€/y		Mass flow, TPD	2436		
Filling compression, Pin=35 -> Pout=140 bar, A=1.1			2.1		2.1	3.0	33	29328	8.8		35	20	2947				32275	Energy flow, MW HHV	4000	
Metering + Scraper trap									5.2		5.2	20	434				434	Transported per y, TPA	888964	
Pipeline (Pipe + Booster comp. + Isolation stations)			2.5		2.5	3.5	39	34575	351		701	50	39945				74520	Power cost, €/GJ	11	
Total					6.5						742		43327				107229			
																	€/t	121		

Table 30: Calculation example - Pipeline CH2 - big pipe.

This calculation example is identical to the above but just for a larger capacity and a longer distance.

Additionally, the example is similar to the calculation in the first table of Table 21. The major difference are

- CAPEX €/(km*MW): is "351" in Table 14 and "333" in Table 21. Reason for the difference is that in Table 21, cost functions of the individual component (pipe, isolation & vent station and booster compressors – i.e. the red, purple and gray curve in Figure 14) is used while the overall cost function (i.e the blue curve in Figure 14) is applied in Table 14.
- A utilization factor of 100% is used here while it is 75 % in Table 21

Truck – CH2 calculation example

Truck - CH2	Fixed O&M - % of CAPEX:	5	WACC, %	5	Operation hours per year, h/y	8000											
Fuel:	CH2	LHV	120 MJ/kg	Power/fuel input				CAPEX	life-time	CAPEX +	OPEX (1)		Tot. Cost	Driving speed, km/h	60		
Transport distance:	100 km	Density	33 kg/m³	MW	GJ/t	€/t	k€/y	€	€	€	€	€	k€/y	k€/y	Loading/unloading time	4.3	
Transport capacity:	1.5 t/truck	No. Trucks	14.0	%				MW	km³/MW	y	k€/y	m³	km³/m³	k€/y	Roundtrip duration, h	7.6	
Filling compression, Pin=35 -> Pout=350 bar, A=1.1				4.2	3.8	5.0	55	1219	50		4.7	20	392		1611	Trips per year	1055
Loading/unloading (wage + depreciation)													4.1	2761	2761	Mass flow, TPD	67
Driving (wage + fuel + depreciation)				fuel consumption is part of OPEX									0.08	5388	5388	Energy flow, MW LHV	93
Total														8149	9759	Transported per y, TPA	22224
Note 1: Assume 29 €/GJ diesel, 24 MJ/km											DKK/kg	3.3	€/t	439	Power cost, €/GJ	11	

Table 31: Calculation example - CH2 truck

This example calculated the cost associated with truck transport of CH2. It is calculated with the same transported capacity as pipeline in section *Pipeline – CH2 calculation example*.

The red OPEX parameters for the loading/unloading and driving is found in the datasheet for the truck.

Storage have not been included; If filling compressor do not fill directly into truck-trailer tubes, storage and additionally filling compressor is needed. Alternatively, if produced hydrogen is filling directly into the trailer tubes, additionally trailers is required.

Additionally, loading arm (see Figure 20) is missing too, but this is assumed to be neglectable compared with the other costs.

Ship – LNH3

Ship - LNH3		Fixed O&M - % of CAPEX:	5	WACC, %	5	Power/fuel input		CAPEX			life-time	CAPEX + Fixed O&M	Port cost		Tot. Cost				
Fuel:	LNH3	LHV=	18.9 MJ/kg	Dens.=	626 kg/m ³	€	€	€	€	€	€	€	€	€	€	€	€		
Transport distance:	10000 km	MJ/km		GJ/trip		k€/y		€	€	€	€	€	€	€	€	€	€		
Transport capacity:	45000 t/tank	MJ/km		GJ/trip		k€/y		€	€	€	€	€	€	€	€	€	€		
Storage tanks	Tank vol (10% excess)	2x 79000 m ³						300	47	30	3238					3238	Transport velocity, km/c	580	
Filling/emptying pumps	Vol.flow (duration 24 h)	3300 m ³ /h	SP=0.4 MW, 2*24 h	69.1	7.0				1.3	20	106					113	Loading/unloading time	3.3	
Loading arms									2.5	20	211					211	Roundtrip duration, d	37.7	
Piping and foundation (not included here - depend strongly on location)																	Trips per year	9.19	
Ship				2435		36525	2582				1750	79	20	6635	1.7	682	9899	Mass flow, TPD	1193
Total																682	10223	Energy flow, MW LHV	261
																€	€	Transported per y, TPA	413533
																€	€	Power cost, €/GJ	11
																€	€	HFO cost, €/GJ	8
																€/t	25		

Table 32: Calculation example – Ship – LNH3

This example gives an overview of the cost associated with LNH3. LNH3 is produced as a liquid why liquefaction of NH₃ is not included.

For ships, storage tanks in both departure and destination harbor is requires as well as filling/emptying pumps and loading/unloading pipes.

Cost of refrigerated storage tanks are found in Table 12. The value for ship are (all value come from the technology datasheet for ships):

1. Fuel consumption of 2435 MJ/km
2. CAPEX for ship of 1750 €/t
3. Port cost of 1.7 €/t

131 Transport by pipeline

Brief technology description

Elements in pipe transmission net

Major elements in a transmission net are (see Figure 12):

1. **Filling pump/compressor:** A filling station is needed to raise the pressure from the outlet pressure of the production unit to the pressure within the transmission net.
2. **Boosting pump/compressor:** Boosting the pressure along the route to overcome friction loss is needed when the pressure drops below the minimum operating pressure.
3. **Isolation valve/vent station:** To seal off segments in case of leakage. The allowable distance between isolation valves will depend on a risk assessment of each section. In populated areas isolation valves are expected more frequently than in rural areas. Typical distance between isolation valves onshore are 10-20 km. Within this catalogue, isolation/vent station for every 20 km have been assumed.
4. **Fiscal metering stations (M/R):** As described in *Fiscal metering stations*, two independent fiscal metering station will most likely be installed after the filling station.
5. **Cathodic protection:** Cathodic protection included as per shown in Figure 12 (green box with CP), i.e. one for filling station, two for each isolation valve/vent station and two for each boosting station.
6. **Scraper traps:** To maintenance/clean the pipeline, a scraper lancer and a scraper receiver is needed (or a valve arrangement will allow for connection of mobile lancer and receivers) in either ends of the pipe.

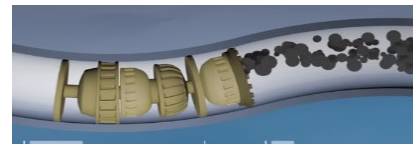

Figure 12: Scraper (also called pig) used to clean/inspect a pipeline

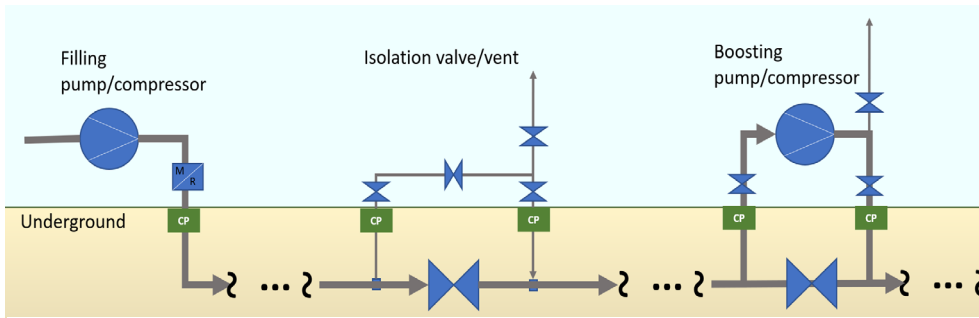

Figure 13: Major elements in a transmission pipe net

Filling compressor, fiscal metering station and scraper traps are installations required at the inlet (and/or outlet) or the pipe. Therefore, these costs have not been included in the "cost per km" estimate. The cost of the filling compressor, the fiscal metering station and the scraper trap are listed in Figure 14.

Existing pipelines

Some key existing pipelines are listed in the following table.

131 Transport by pipeline

Fluid	Country/ company	Pd, barg	Mat.	Pipe type	Welding	Dn	km	Year	Ref.
NG	DK, transmission	80				Up to 48"	900		ISO 13623:2017
	DK, distribution	40, 19, 4					17000		REDEGØRELSE FOR GASFORSYNINGSSIKKERHED 2019 Energinet
H ₂	US,	<68					450-800 miles	1930	Ref. 2
	GE (Rhine and Ruhr), AL	17 and 20-210	≤X42	ERW	SMAW	10-12	240	1938 -	10000 kg/h ref. 2, 1 and 30]
	France, AL	97	≤X52	ERW	SMAW		1000	1973-1997	
	NL, Gasunie	100				~10"	237		Convert existing NG to H ₂ 2018 ref. 5, 15
	GE, FNB Gas						5900 (1)		Partly converting existing NG pipelines
	GE, Central, Linde								
	US, Texas, AL Corpus Christi	48 (first) 24 (now)	Gr.B (0)	ERW	SMAW	8	100	1997	Originally crude oil pipelines (1940-50). Ruptured because of corrosion in 1998.
	US, Texas, AL Freeport to Texas city	51	X60 (0)	ERW	SMAW		54	1997	Originally crude oil pipelines until 1979. Compressor: Lubricating reciprocal + multi-stage filtration for lube oil removal
	US, Plaquemine-Chalmette ref. 4, 31, AP					14	240 (965)	209	New pipeline connected the two above give a total of 965 km H ₂ piping.
NH ₃	US	17	CS				~5000		ASTM A333 ref. 15, ref 28

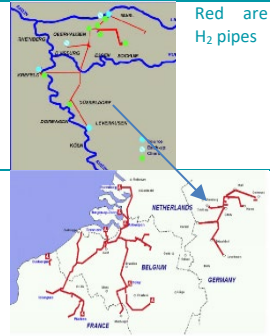

Table 33: Key existing pipes (not all are included)

Table notes:
Not constructed yet but is planned

See detailed material properties in ref. 1.

Operation pressure

As mentioned in section *Transport form – chemical phase*, pipeline-fluid-phase will be in the following forms:

Fluid	Phase	Pmin/Pmax/Pdesign, barg
H ₂	Compressed gas	40/140/156 40/70/80
NH ₃	Compressed liquefied gas	20/20 /23
DME		13/20 /23
Liquid HC	Liquid	3 /8 /10

Table 34: Pipe pressures to be considered in this catalogue.

A max operating pressure of 140 barg have been used in this catalogue. When building new network, 140 barg is believed to be the optimal pressure as this will give the largest buffer/storage capacity. Pressure above have not been selected as this will impose higher risk of hydrogen embrittlement. As major part of the existing natural gas net is designed to 80 barg, 70 barg has also been used in calculations as part of the natural gas transmission net can be converted to hydrogen transmission net.

Converting NG pipes to H₂ pipes

It is possible to use existing NG grid, though with some modifications [ref. 16 and 24].

Gasunie have realized a hydrogen backbone pipeline infrastructure in NL by converting NG pipes to H₂ pipelines.

Within ref. 8, the cost of converting existing NG-transmission pipes to H₂-transmission has been assumed to be equal to 1/3 of cost of new installation.

As the biogas production is relatively extensive in DK and as DK have committed to transport of NG from Norway to Poland (EPII) it is expected that only minor part of the natural gas grid that will be converted to hydrogen transmission grid in the near/medium term.

The existing natural gas transmission net in DK have a design pressure of 80 barg and a min operating pressure of 60 barg.

Underground pipeline

Pipelines should to the extent possible be underground as:

- 1 Mitigation of risk: Underground installation reduces the likelihood of damage/vandalism and the risk of explosion in in case of leakage
- 2 Temperature is less variable: This reduces the expansion and shrinkage of the construction material. Additionally, winterization is not needed if freezing point is below 0°C
- 3 Do not disfigure the nature and is less prone to protest

Key requirements to underground piping:

- 1 Connections: To minimize the possibility of leaks, all underground connections should be welded
- 2 Cathodic protection: To eliminate damage caused by lightning, underground pipes must be electric isolated from above ground installations via isolating flanges
- 3 Corrosion: Galvanic corrosion is caused by difference in electric potential between the pipe and the soil. External coating, electrical measures (i.e. sacrificial anode or impressed current) that mitigate galvanic corrosion if there are coating-defects, and monitoring of the corrosion protection system is a must
- 4 Pipe casings/load shields where above ground loading can occur (i.e. railroad, etc.)
- 5 Underground pipeline should be clearly marked - Ref 3 consider accidents caused by excavation of existing pipes



Aboveground pipeline

Most equipment (fiscal metering, compressor/pumping stations, etc.) will normally be above ground installations.

Key requirements to aboveground piping:

- 1 Connections: Generally, flanged (bolted and non-welded) connection is used above ground. However, as hydrogen is more prone to leakage, welded connections should be considered whenever practical.
- 2 Cathodic protection: All above ground piping shall have electrical continuity across all connections, except insulated flanges, and shall be earthed at suitable intervals to protect against lightning and static electricity
- 3 Corrosion: Coating is normally applied to minimize environment corrosion. The type and amount depend on location.



Input

Input is fluid at operation pressure given in Table 18. The flow is given by the optimal pressure drop and velocities listed in Table 19

Output

The output is the same as the input. Exception is pressure, which can be somewhere between the min and the max pressure allowed in the transmission net.

Efficiency and losses

Energy loss occurs as a result of fluid frictional loss (pressure drop) in the pipelines. The friction loss is a strong function of fluid velocity. Thus, the optimal design velocity is a trade-off between capital cost (pipeline diameter) and operating cost (pumping/compression energy).

For the technology catalogue, a cost optimization has been performed. The dP/dL (dP/dL=pressure drop per km) listed in Table 19 give a good trade-off between CAPEX and OPEX (both for operation pressures at 70 bar as well as for operating pressures at 140 bar). The optimum depends on the length of the pipe, cost of the booster vs cost of the piping material.

	dP/dL, bar/km	Velocity, m/s
H ₂	$dP/dL(\max) \approx 1.28 \times Q^{-0.75}$	P=140 bar $V \approx 4.4 \times Q^{0.1}$ P=70 bar $V \approx 6.7 \times Q^{0.1}$
Liquid fluids (NH ₃ , DME, LHC)	dP/dL(max)=0.04 bar/km	

Table 35: Optimal/max pressure drop per km (dP/dL, bar/km), Q=duty transported in MW

Application potential

H₂: Hydrogen is a key component that is required for optimal production of any synthetic fuels. This include any CCU process, NH₃ production, fuel production from residue biomass/waste (the efficiency converting residue biomass/waste to synthetic fuel can be almost doubled by adding hydrogen) and H₂ fueling stations.

NH₃, DME and LHC: As they are not the "base" element, i.e. the element that is needed for production of all other fuels, and as they are much easier to transport in larger quantities via mobile transportation, pipelines will most likely just be point to point solutions where larger capacities need to be transported.

Typical capacities

The capacities considered in this catalogue are listed in the following table:

Fluid	Mass flow TPD	Energy flow MW (HHV)	DN inch	Pmax barg	T °C
H ₂	40-13000	80-20000	4-48	140	Amb.
	40-9000	80-15000	4-48	70	
NH ₃		10-2600	4-24	20	
DME	50-10000	20-3700	4-24	20	
Toluene		20-5000	4-24	10	

Table 36: Capacities considered in this catalogue. To convert the energyflow into LHV based flow, multiply with 120/142=0.85.

It is assumed that the transmission piping is underground piping and for underground piping 4" is selected as a minimum pipe-size. Therefore, for very low capacity, the pipes become quite expensive per unit capacity.

Environmental

The construction phase of a pipeline may have environmental impact depending on the chosen route. An environmental impact assessment (VVM) will be required.

Once the pipeline is constructed it will only have marginal environmental impact.

Blow down of pipeline sections for maintenance or repair work will be rare and done in a slow and controlled manner that will have insignificant environmental impact.

Research and development perspectives

Transmission and distribution pipes for both H₂, NH₃, DME and non-corrosive liquid hydrocarbons is a well-known technology (TRL=8-9).

Improvements and associated cost reduction:

1. Hydrogen compression:
 - 1.1. Increase the suction pressure
 - 1.2. Several interstage compressors that is optimized so only compressing to the actual discharge pressure
2. Material of construction:
 - 2.1. Challenge existing assumptions such as reviewing the limitation on hardness or the belief that higher grades of pipeline steel will be more susceptible to hydrogen embrittlement
 - 2.2. Approval of newer low alloy steels for H₂ services: It is judged that there is room for larger cost reduction due to improved materials ref. 6.
 - 2.3. Plastic pipes, may especially be optimal for smaller distribution pipes
3. Max operating pressure:
 - 3.1. Cost calculation within this report shows that the cost advantages of increasing the pressure is limited. However, this will most likely change if stronger alloys are approved for hydrogen service.
4. Design code:
 - 4.1. Standardisation and development of Eurocodes for hydrogen pipes (i.e. CEN 234 working group or EIGA)
5. Installation cost:

- 5.1. Position drilling might reduce installation cost substantially: Directional drilling makes pipelines that crosses streams, existing constructions, etc. much cheaper especially in industrial/urban areas.
- 5.2. Converting NG pipes to H₂ pipes will make a major reduction in CAPEX.
- 5.3. Put a smaller H₂ pipeline into an existing NG pipeline

Prediction of performance and costs

Investment cost (CAPEX)

The investment cost will include

- 1. Cost of equipment, piping, piping elements¹² and instrumentations¹³
- 2. Installation costs
- 3. Approvals, expropriation, etc.



Figure 14: Equipment, installation and difficulties associated with installation in larger cities

For onshore pipelines COWI has made an own estimate of the investment cost based on inhouse experience obtained from engineering and installation of natural gas transmission lines in Denmark. The own estimate is benchmarked against references from the literature.

The following assumptions are used for estimate of pipeline investment cost:

- 1. A class location safety factor¹⁴ of 0.4 for small pipes and 0.5 for large pipes is used. Pipeline construction material is carbon steel (X52) with polymer coating.
- 2. The design dP/dL is based on values given in Table 19
- 3. Cathodic protection is included as per Figure 12.

¹² Insulation valves, vent valves, cathodic protections, etc.

¹³ Transmitters for measuring pressure, flow, etc.

¹⁴ Lower class location safety factor means thicker pipes. 0.4 is selected for small pipes (assumed installed in populated areas, i.e. pipe to refueling stations) while 0.5 is selected for large pipes which are assumed to be installed in less populated areas

4. Booster station is added to ensure that the pressure do not drop below the minimum allowable pressure
5. Sectionalisation vales (ESD) with ancillaries every 20 km is assumed. This is uncertain as regulative requirements for H₂ pipelines in DK is unclear.
6. Installation cost includes trenching and 8 % for controlled drilling, permitting and environmental investigations
7. Cost factor for engineering and follow-up added (6 to 10% depending on size).
8. Unit cost based on pipeline distance of 200 km. For very short pipelines the unit cost will increase.

Figure 14 shows a system with 35 bar inlet filling compressor and a respectively a 140 bar (lefthand side) and 70 bar (righthand side) operating pressure. In each of the two figures cost and energy loss curves and associated formulas are given depending on the pipeline capacity. These cost and energy loss curves are used to calculate the examples in Table 21 and Table 22 and represent estimated values for 2020.

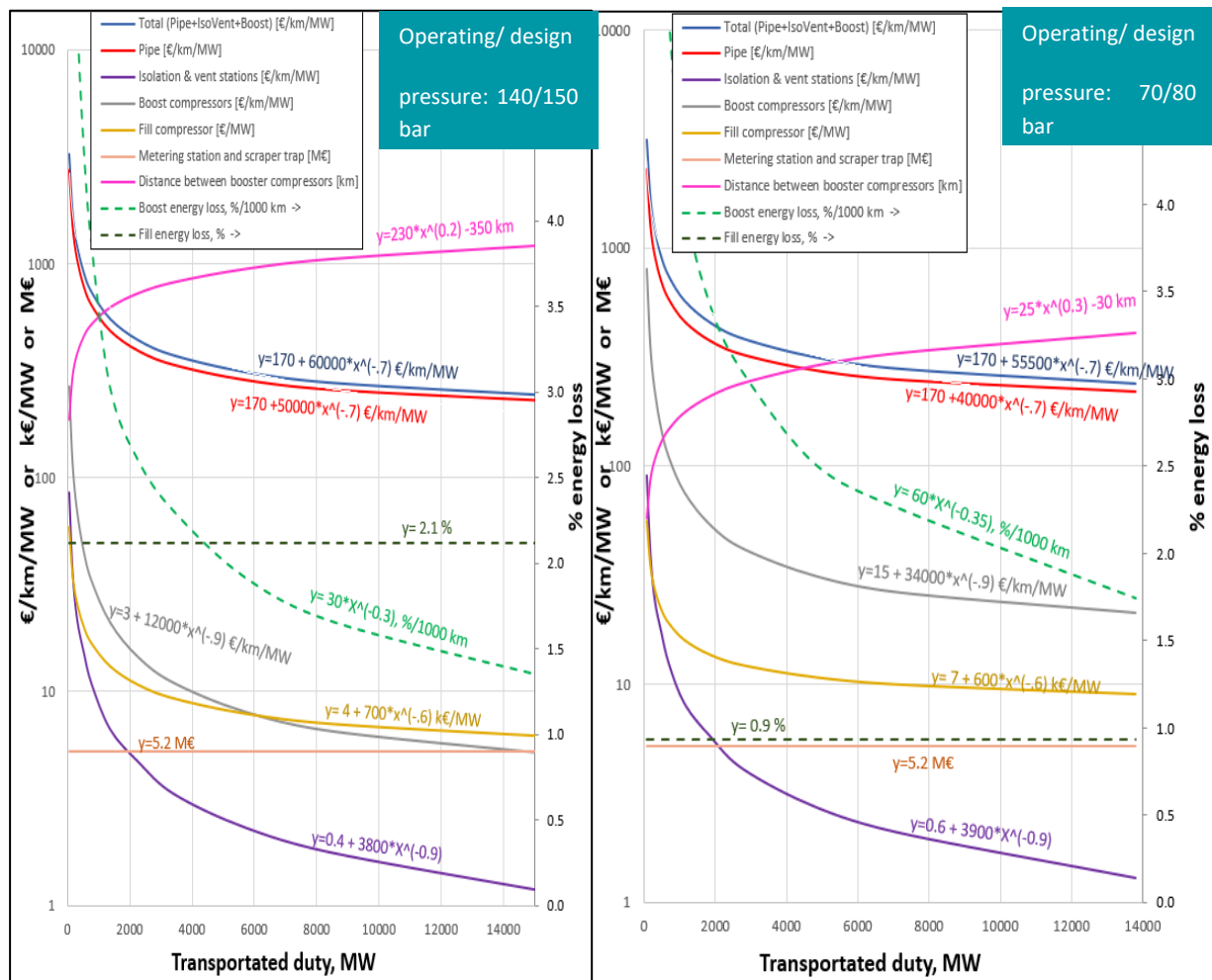

Figure 15: Estimated CAPEX, compression losses and distance between booster compressor vs. transported duty (HHV) for hydrogen transmission pipes. Examples of how to use the figures are given in tables below.

The above curves are based on 100% utilization. Cost for reduced utilization is obtained by multiplying the cost per capacity with $(100/X)$ where X is the average utilization percentage (the examples below is calculated assuming 75 % utilization).

Figure 14 also include a formula for calculating the distance between the booster compressors.

The cost formulas given in Figure 14 are only valid provided the design pressure drop is approximately as per formula in Table 19. As the design pressure drop has been optimized with respect to cost, both lower and higher design pressure drops will tend to increase the cost. Lower design pressure will increase the pipe-diameter/pipe-cost while higher design pressure drop will increase the booster compressor expenses.

131 Transport by pipeline

		Capacity - Energy		Capacity - Mass flow		Pressures		Notes: Note 1 = $170+60000 \cdot MW^{(0.7)}/1000$, [€/m/MW], MW=2500 MJ/s Note 2 = $30 \cdot MW^{(0.3)}$, [%/(MW*1000km)], MW=3250 MJ/s Note 3 = discharge pressure for filling and boosting compressor Note 4 = inlet pressure for boosting compressor									
length, km	500	4000	MW HHV	888,964	TPY	Inlet filling compressor, bar	35										
WACC, %	5	126,144,000	GJ/y	2436	TPD	Max grid, bar (note 3)	140										
Power cost, €/MWh	60	345,600	GJ/day	1128	kNm3/h	Min grid, bar (note 4)	40										
Utilization	75	3383	MW LHV	1011	MMSCF/d												
Item	Source	Lifetime y	Formular	% loss	% loss	MW	€	k€	M€	M€	€	€	Datasheet				
			calc. orange cell	MW*1000kr	MW	MW	MW*km	MW	M€	M€	ton H2	GJ					
CAPEX	Pipe (material and installation)	Figure 2.4	50	$170 + 50000 \cdot MW^{(0.7)}$, [€/km/MW]			320	160	641	35	53	0.371	Not in datasheet				
	Isolation & vent stations	Figure 2.4	50	$0.4 + 3800 \cdot MW^{(0.9)}$, [€/km/MW]			2.6	1.3	5	0.3	0.4	0.003	Not in datasheet				
	Booster compressors	Figure 2.4	20	$3 + 12000 \cdot MW^{(0.9)}$, [€/km/MW]			9.9	4.9	20	1.6	2.4	0.017	Not in datasheet				
	=> Total per length	Sum		Sum			333	166	666	37	55	0.391	0.4 (note 1)				
	Filling compressor	Figure 2.4	20	$4 + 700 \cdot MW^{(0.6)}$, [€/MW]				8.8	35	2.83	4.3	0.030	Not in datasheet				
	Metering station + scraper trap	Figure 2.4	50	5.2 [€]					5.2	0.3	0.4	0.003	Not in datasheet				
=> TOTAL	Sum		Sum					706	40	60	0.424						
OPEX	Filling compressor - power @ 100% cap.	Figure 2.4		$1.1 \cdot (P_{in}^{(1/3)} - P_{out}^{(1/3)})$, [%/MW]	2.1	63				33	50	0.352	2.1 = 2.1 % in datasheet				
	Booster compressors - power @ 100% cap.	Figure 2.4		$30 \cdot MW^{(0.3)}$, [%/(MW*1000km)]	2.5	37				20	29	0.208	2.7 (note 2)				
	Fixed O&M									1	1.5	0.011	0.5 €/km/y/MW				
	=> TOTAL									54	81	0.570					
TOTAL									94	141	0.99						

		Capacity - Energy		Capacity - Mass flow		Pressures		Notes: Note 1 = $170+60000 \cdot MW^{(0.7)}/1000$, [€/m/MW], MW=20000 MJ/s Note 2 = $30 \cdot MW^{(0.3)}$, [%/(MW*1000km)], MW=7500 MJ/s Note 3 = discharge pressure for filling and boosting compressor Note 4 = inlet pressure for boosting compressor									
length, km	1000	13000	MW HHV	2,889,133	TPY	Inlet filling compressor, bar	35										
WACC, %	5	409,968,000	GJ/y	7915	TPD	Max grid, bar (note 3)	140										
Power cost, €/MWh	60	1,123,200	GJ/day	3667	kNm3/h	Min grid, bar (note 4)	40										
Utilization	75	10994	MW LHV	3285	MMSCF/d												
Item	Source	Lifetime y	Formular	% loss	% loss	MW	€	k€	M€	M€	€	€	Datasheet				
			calc. orange cell	MW*1000kr	MW	MW	MW*km	MW	M€	M€	ton H2	GJ					
CAPEX	Pipe (material and installation)	Figure 2.4	50	$170 + 50000 \cdot MW^{(0.7)}$, [€/km/MW]			236	236	3067	168	78	0.546	Not in datasheet				
	Isolation & vent stations	Figure 2.4	50	$0.4 + 3800 \cdot MW^{(0.9)}$, [€/km/MW]			1.2	1.2	15	0.8	0.4	0.003	Not in datasheet				
	Booster compressors	Figure 2.4	20	$3 + 12000 \cdot MW^{(0.9)}$, [€/km/MW]			5.4	5.4	70	5.6	2.6	0.018	Not in datasheet				
	=> Total per length	Sum		Sum			242	242	3152	174	81	0.567	0.2 (note 1)				
	Filling compressor	Figure 2.4	20	$4 + 700 \cdot MW^{(0.6)}$, [€/MW]				6.4	83	6.66	3.1	0.022	Not in datasheet				
	Metering station + scraper trap	Figure 2.4	50	5.2 [€]					5.2	0.3	0.1	0.001	Not in datasheet				
=> TOTAL	Sum		Sum					3240	181	84	0.590						
OPEX	Filling compressor - power @ 100% cap.	Figure 2.4		$1.1 \cdot (P_{in}^{(1/3)} - P_{out}^{(1/3)})$, [%/MW]	2.1	206				108	50	0.352	2.1 = 2.1 % in datasheet				
	Booster compressors - power @ 100% cap.	Figure 2.4		$30 \cdot MW^{(0.3)}$, [%/(MW*1000km)]	1.7	171				90	41	0.292	2.1 (note 2)				
	Fixed O&M									7	3.0	0.021	0.5 €/km/y/MW				
	=> TOTAL									204	94	0.665					
TOTAL									386	178	1.25						

		Capacity - Energy		Capacity - Mass flow		Pressures		Notes: Note 1 = $170+60000 \cdot MW^{(0.7)}/1000$, [€/m/MW], MW=20000 MJ/s Note 2 = $30 \cdot MW^{(0.3)}$, [%/(MW*1000km)], MW=20000 MJ/s Note 3 = discharge pressure for filling and boosting compressor Note 4 = inlet pressure for boosting compressor									
length, km	1000	30000	MW HHV	6,667,230	TPY	Inlet filling compressor, bar	35										
WACC, %	5	946,080,000	GJ/y	18266	TPD	Max grid, bar (note 3)	140										
Power cost, €/MWh	60	2,592,000	GJ/day	8463	kNm3/h	Min grid, bar (note 4)	40										
Utilization	75	25370	MW LHV	7582	MMSCF/d												
Item	Source	Lifetime y	Formular	% loss	% loss	MW	€	k€	M€	M€	€	€	Datasheet				
			calc. orange cell	MW*1000kr	MW	MW	MW*km	MW	M€	M€	ton H2	GJ					
CAPEX	Pipe (material and installation)	Figure 2.4	50	$170 + 50000 \cdot MW^{(0.7)}$, [€/km/MW]			207	207	6202	340	68	0.479	Not in datasheet				
	Isolation & vent stations	Figure 2.4	50	$0.4 + 3800 \cdot MW^{(0.9)}$, [€/km/MW]			0.8	0.8	23	1.2	0.2	0.002	Not in datasheet				
	Booster compressors	Figure 2.4	20	$3 + 12000 \cdot MW^{(0.9)}$, [€/km/MW]			4.1	4.1	124	9.9	2.0	0.014	Not in datasheet				
	=> Total per length	Sum		Sum			212	212	6348	351	70	0.494	0.2 (note 1)				
	Filling compressor	Figure 2.4	20	$4 + 700 \cdot MW^{(0.6)}$, [€/MW]				5.4	163	13.10	2.6	0.018	Not in datasheet				
	Metering station + scraper trap	Figure 2.4	50	5.2 [€]					5.2	0.3	0.1	0.000	Not in datasheet				
=> TOTAL	Sum		Sum					6517	364	73	0.513						
OPEX	Filling compressor - power @ 100% cap.	Figure 2.4		$1.1 \cdot (P_{in}^{(1/3)} - P_{out}^{(1/3)})$, [%/MW]	2.1	476				250	50	0.352	2.1 = 2.1 % in datasheet				
	Booster compressors - power @ 100% cap.	Figure 2.4		$30 \cdot MW^{(0.3)}$, [%/(MW*1000km)]	1.4	306				161	32	0.227	1.5 (note 2)				
	Fixed O&M									15	3.0	0.021	0.5 €/km/y/MW				
	=> TOTAL									426	85	0.600					
TOTAL									790	158	1.11						

Table 37: Calculation example – H₂ pipe cost using Fejl! Henvissningskilde ikke fundet.a – P=140 bar and average utilization of 75% is used.

In Table 21 and Table 22, detailed cost estimates for various hydrogen transmission pipe capacity and length are given.

The first table calculate the cost for a 500 km pipe transporting 4000 MW (based on HHV). The pressure operating range is 40-140 bar and the filling pressure is 35 bar. An average utilization/load percentage of 75% is applied.

In Figure 14 the blue curve is the sum of:

- The red curve (pipe cost)
- The purple curve (insulation and vent station cost) and
- The gray curve (booster compressor cost).

Colors in Table 21 and Table 22 follow the color code in Figure 14.

In Table 21 the sum of the first, second and third row (row with red, purple and gray numbers) adds to the fourth row (i.e. the row with the blue numbers).

The "0.4 €/m/MW" listed in the "datasheet" column (the first example) is the value taken from the "Investment costs" data in the data sheet. This value is based on the formula for the blue curve (sum of pipe cost, insulation and vent station cost and booster compressor cost):

$$Investment\ Cost\ \left(\frac{\text{€}}{\text{meter} * MW}\right) = 170 + 60,000 * \frac{MW^{(-0.7)}}{1000}$$

Where 2500 MW (HHV) is used for the interval 1000-4000 MW line.

The power used for booster compression in Figure 14 and in the examples above are included in the "Energy losses" in the data sheet. This cost item in the data sheet is based on the formula:

$$Energy\ losses\ \left(\frac{\%}{MW * 1000\ km}\right) = 30 * MW^{(-0.3)}$$

Where 3250 MW (HHV) is used for the interval 1500-5000 MW line. This results in (rounded to) 2.7% loss pr. MW pr. 1000 km for pipeline capacity in the given interval.

The total cost for the 4,000 MW 500 km pipeline is 131 €/ton transported H₂ (or 0.92 €/GJ transported H₂ – note the energy is based on HHV).

The same calculation is performed for 1,000 km pipe with both 13,000 and 30,000 MW capacity. All calculations performed in Table 21 are repeated in the following table with P=70 bar instead of 140 bar.

131 Transport by pipeline

		Capacity - Energy		Capacity - Mass flow		Pressures			
length, km	500	4000	MW HHV	888,964	TPY	Inlet filling compressor, bar	35	Note 1: = 170-55500* MW ^{0.7} /1000, [€/m/MW], MW=2500 MJ/s	
WACC, %	5	126,144,000	GJ/y	2436	TPD	Max grid, bar (note 3)	70	Note 2: = 60* MW ^{0.35} , 1%/(MW*1000km), MW=3250 MJ/s	
Power cost, €/MWh	60	345,600	GJ/day	1128	kNm3/h	Min grid, bar (note 4)	40	Note 3: = discharge pressure for filling and boosting compressor	
Utilization	75	3383	MW LHV	1011	MMSCF/d			Note 4 = inlet pressure for boosting compressor	

Item	Source	Lifetime y	Formular calc. orange cell	% loss MW*1000km	%loss MW	MW	€ MW*km	€ MW	€ M€	€ M€ y	€ ton H2	€ GJ	Datasheet
Pipe (material and installation)	Figure 2.4	50	170 + 40000 * MW ^{0.7} , [€/km/MW]				290	145	581	32	48	0.336	Not in datasheet
Isolation & vent stations	Figure 2.4	50	0.6 + 3900 * MW ^{0.9} , [€/km/MW]				2.8	1.4	6	0.31	0.5	0.003	Not in datasheet
Booster compressors	Figure 2.4	20	15+34000* MW ^{0.9} , [€/km/MW]				34.5	17.2	69	5.5	8.3	0.058	Not in datasheet
=> Total per length	Sum						328	164	655	38	56	0.398	0.4 (note 1)
Filling compressor	Figure 2.4	20	7+ 600* MW ^{0.5} , [€/MW]				11.1	45	3.58	5.4	0.038		Not in datasheet
Metering station + scraper trap	Figure 2.4	50	5.2 [€]						5.2	0.3	0.4	0.003	Not in datasheet
=> TOTAL	Sum						705	42	62	62	0.439		
Filling compressor - power @ 100% cap.	Figure 2.4		1.1 * (P ^{0.7} *(1/3)-P ^{0.4} *(1/3)), [%/MW]		0.9	28			15	22	0.156		0.9 = 2.1 % in datasheet
Booster compressors - power @100% cap.	Figure 2.4		60* MW ^{0.35} , [%/(MW*1000km)]	3.3	1.6	49			26	39	0.274		3.5 (note 2)
Fixed O&M									1	1.5	0.011		0.5 €/km/y/MW
=> TOTAL									42	63	0.441		
TOTAL									83	125	0.88		

		Capacity - Energy		Capacity - Mass flow		Pressures			
length, km	1000	13000	MW HHV	2,889,133	TPY	Inlet filling compressor, bar	35	Note 1: = 170-55500* MW ^{0.7} /1000, [€/m/MW], MW=20000 MJ/s	
WACC, %	5	409,968,000	GJ/y	7915	TPD	Max grid, bar (note 3)	70	Note 2: = 60* MW ^{0.35} , 1%/(MW*1000km), MW=7500 MJ/s	
Power cost, €/MWh	60	1,123,200	GJ/day	3667	kNm3/h	Min grid, bar (note 4)	40	Note 3: = discharge pressure for filling and boosting compressor	
Utilization	75	10994	MW LHV	3285	MMSCF/d			Note 4 = inlet pressure for boosting compressor	

Item	Source	Lifetime y	Formular calc. orange cell	% loss MW*1000km	%loss MW	MW	€ MW*km	€ MW	€ M€	€ M€ y	€ ton H2	€ GJ	Datasheet
Pipe (material and installation)	Figure 2.4	50	170 + 40000 * MW ^{0.7} , [€/km/MW]				223	223	2896	159	73	0.516	Not in datasheet
Isolation & vent stations	Figure 2.4	50	0.6 + 3900 * MW ^{0.9} , [€/km/MW]				1.4	1.4	18	1.0	0.5	0.003	Not in datasheet
Booster compressors	Figure 2.4	20	15+34000* MW ^{0.9} , [€/km/MW]				21.7	21.7	283	22.7	10.5	0.074	Not in datasheet
=> Total per length	Sum						246	246	3196	182	84	0.593	0.2 (note 1)
Filling compressor	Figure 2.4	20	7+ 600* MW ^{0.5} , [€/MW]				9.0	118	9.43	4.4	0.031		Not in datasheet
Metering station + scraper trap	Figure 2.4	50	5.2 [€]						5.2	0.3	0.1	0.001	Not in datasheet
=> TOTAL	Sum						3319	192	89	0.624			
Filling compressor - power @ 100% cap.	Figure 2.4		1.1 * (P ^{0.7} *(1/3)-P ^{0.4} *(1/3)), [%/MW]		0.9	91			48	22	0.156		0.9 = 2.1 % in datasheet
Booster compressors - power @100% cap.	Figure 2.4		60* MW ^{0.35} , [%/(MW*1000km)]	2.2	2.2	212			112	52	0.363		2.6 (note 2)
Fixed O&M									7	3.0	0.021		0.5 €/km/y/MW
=> TOTAL									166	77	0.540		
TOTAL									358	165	1.16		

		Capacity - Energy		Capacity - Mass flow		Pressures			
length, km	1000	30000	MW HHV	66,672,304	TPY	Inlet filling compressor, bar	35	Note 1: = 170-55500* MW ^{0.7} /1000, [€/m/MW], MW=20000 MJ/s	
WACC, %	5	9,460,800,000	GJ/y	182664	TPD	Max grid, bar (note 3)	70	Note 2: = 60* MW ^{0.35} , 1%/(MW*1000km), MW=20000 MJ/s	
Power cost, €/MWh	60	25,920,000	GJ/day	84633	kNm3/h	Min grid, bar (note 4)	40	Note 3: = discharge pressure for filling and boosting compressor	
Utilization	75	253700	MW LHV	75816	MMSCF/d			Note 4 = inlet pressure for boosting compressor	

Item	Source	Lifetime y	Formular calc. orange cell	% loss MW*1000km	%loss MW	MW	€ MW*km	€ MW	€ M€	€ M€ y	€ ton H2	€ GJ	Datasheet
Pipe (material and installation)	Figure 2.4	50	170 + 40000 * MW ^{0.7} , [€/km/MW]				176	176	52759	2890	58	0.407	Not in datasheet
Isolation & vent stations	Figure 2.4	50	0.6 + 3900 * MW ^{0.9} , [€/km/MW]				0.6	0.6	194	10.6	0.2	0.001	Not in datasheet
Booster compressors	Figure 2.4	20	15+34000* MW ^{0.9} , [€/km/MW]				15.4	15.4	4620	371	7.4	0.052	Not in datasheet
=> Total per length	Sum						192	192	57572	3271	65	0.461	0.2 (note 1)
Filling compressor	Figure 2.4	20	7+ 600* MW ^{0.5} , [€/MW]				7.3	2193	176	3.5	0.025		Not in datasheet
Metering station + scraper trap	Figure 2.4	50	5.2 [€]						5.2	0.3	0.0	0.000	Not in datasheet
=> TOTAL	Sum						59771	3448	69	0.486			
Filling compressor - power @ 100% cap.	Figure 2.4		1.1 * (P ^{0.7} *(1/3)-P ^{0.4} *(1/3)), [%/MW]		0.9	2,104			1106	22	0.156		0.9 = 2.1 % in datasheet
Booster compressors - power @100% cap.	Figure 2.4		60* MW ^{0.35} , [%/(MW*1000km)]	0.7	0.7	1,634			859	17	0.121		1.9 (note 2)
Fixed O&M									150	3.0	0.021		0.5 €/km/y/MW
=> TOTAL									2115	42	0.298		
TOTAL									5563	111	0.78		

Table 38: Calculation example – H₂ pipe cost using Figure 14 b – P=70 bar and average utilization of 75% is used.

Within Table 23 cost vs pipe diameter and duty is listed for both 140 bar and 70 bar pipes. Surprisingly, at very large pipes the cost of P=70 bar pipe is less than for the pipe with P=140 bar. A major reason is

that the optimal dP/dL formula (see Table 19) for the two cases were so similar that the optimal dP/dL for P=70 have been applied for both. Thus, high pressure is from a cost point beneficial at low capacities while at larger capacities the cost become very identical.

As seen in the tables (and Figure 14), it is the "pipe material & installation" and the compressor power-consumption as well as power consumption for filling that contributes to the major part of the cost. Electrolysis Units that operate at higher pressure can in the future eliminate a major part of the filling power consumption.

An additional advantage of the high pressure is the additionally storage capability. The amount of hydrogen gas that can be contained within a given volume of pipe is 1.9 times larger at 140 bar than at 70 bar. Thus, the extra pressure give a huge additionally storage/line packing capability.

100% utilization							
Pressure bar	DN inch	CAPEX P+I+B € m	HHV		LHV		Cost All € kg*1000km
			low MW	high MW	low MW	high MW	
70	4	210		65		55	1.22
	6	265	65	165	55	140	0.70
	8	340	165	285	140	240	0.52
	10	420	285	465	240	395	0.41
	12	470	465	690	395	580	0.34
	16	615	690	1130	580	960	0.27
	20	855	1130	1865	960	1575	0.23
	24	1160	1865	2795	1575	2365	0.20
	30	1390	2795	4845	2365	4095	0.17
	36	1845	4845	7280	4095	6155	0.15
	48	3025	7280	13800	6155	11670	0.13
140	4	230		70		60	1.08
	6	325	70	180	60	150	0.64
	8	430	180	320	150	270	0.48
	10	540	320	540	270	455	0.38
	12	635	540	785	455	665	0.33
	16	800	785	1385	665	1170	0.27
	20	1165	1385	2275	1170	1925	0.23
	24	1595	2275	3420	1925	2890	0.21
	30	2220	3420	5740	2890	4855	0.18
	36	3050	5740	8670	4855	7330	0.17
	48	5060	8670	16440	7330	13905	0.15

P=Pipe, I=Isolation and vent station, B=booster compressors

Table 39: Duty ranges vs nominal diameter (DN) and cost. The cost in the last column is based on the high flow (i.e. the high MW).

Table 24 list cost evaluations from other studies. Applied WACC and assumed life time of investment is unfortunately often not cited. Where sufficient information is given, the calculations have been performed with the cost optimized formulas developed here (i.e. the formulas in Figure 14 have been applied). The values match fine with the Hychain and the European hydrogen backbone studies while the IEA and IES studies seems more conservative than the results using the values in this catalogue.

Other benchmark studies of hydrogen transmission lines	Year	Description of the study	Parameters used within this study						Cost € kg*1000km		
			LHV GW	L km	Pmax bar	Pmin bar	Pfill bar	Retrofit %	Utiliz %	Other	This
European-hydrogen backbone	2020	13 GW (LHV), 48", 100-600 km, 67-80 bar, P=67-80 bar, Pfill=30-40 bar, SP(boost)=190-330 MW/1000 km, 57 % utilization, 75% retrofit of existing piping	13	1000	78	40	35	75	57	0.09-0.17	0.11
Hychain - CAPEX low	2020	1000 km, huge pipes, 50 years, 5% wacc, 100 % capacity use	30	1000	78	40	35	0	100	0.10	0.12
Hychain - CAPEX high											0.18
IEA										0.59	
Hydrogen generation in Europe (EC)											
- Guidehouse	2019	48" pipe including compressor cost. Assume: P=70 bar, 75% utilization	12	1000	70	40	35	0	75	0.23	0.15
- BNEF	2019	34", 75% utilization, 50 km distance. Assume P=70 bar	6	1000	70	40	35	0	75	0.48	0.17
- IES	2019	1500 km								0.57	
Hydrogen europe (2*40 MW)		2500 km, 2 times 48 inch. 50 year, 5% wacc, capacity use 50%. 40 GW require 66" pipe at 140 bar. Else it will be very costly do to high dp Assume 140 bar and 66"	40	1000	140	40	35	0	50	0.08	0.17
									100		0.13

Table 40: Studies found in literature. L=Length, Retrofit is percent retrofit of NG net, and utilize is utilization percentage. The column study list the values given in the listed studies, while the white backgrounded cells list the values calculated with the cost-formulas listed within this document. For all calculation here: WACC=5% and 50 year lifetime on "pipe + isolation station + metering and scruber traps and 20 years on compressors.

Capital cost of liquid fuel pipes (L20 (LPG, NH₃, DME) and LHC):

The capital cost (CAPEX) of pipe transport of liquid fuels can be approximated by the following formula:

$$CM = 56 * MTPD^{-0.77}, \quad [CM] = \left(\frac{\text{€}/m}{MTPD}\right)$$

$$CE = CM * \frac{24 * 3.6}{HHV_{liquid}}, \quad [CE] = \left(\frac{\text{€}/m}{MW}\right), \quad [HHV_{liquid}] = \frac{MJ}{kg}$$

This formula also gives a good approximation of liquefied NH₃, DME and LPG. Thus, the cost per mass unit is approximately the same. The major difference between the different liquids is the specific energy density (HHV) where especially ammonia and alcohol have a lower energy density and is therefore more costly to transfer per energy unit.

Variable operational cost

The variable operation cost will mainly be given by the energy used to boost the pressure as a result of friction losses in the transmission pipe.

Hydrogen (H₂): The booster and filling losses as function of capacity is plotted in Figure 14.

Liquid fuels (NH₃, DME, Toluene): With a dP/dL(max) or 0.04 bar/km, the operation cost is negligible.

Fixed operation cost

The fixed operation cost include maintenance, salaries/wages, etc. While the compressor maintenance cost depends on the capacity of the compressor the fixed O&M have for hydrogen pipes been given as €/km/MW. For liquid carrying pipe, the maintenance cost depends very little on the actual capacity. I.e. a value based on €/km have been judged more appropriate for describing a large capacity range.

Hydrogen (H₂): 4% of average CAPEX have been used for 2020. 2% is used for 2030 and 1.5% is used for 2050. The decrease is judged based on IoT-maintenance of compressor is under strong development. Additionally, for the first pipes, additionally surveillance for hydrogen embrittlement is suspected.

Liquid (NH₃, DME, Toluene): 1% of average CAPEX is assumed. No major reduction in maintenance cost is foreseen.

Uncertainty

As the major cost is pipe material and installation the uncertainty is minor as this is mature technology.

Higher uncertainty is added to the upper end as there is a considerable higher risk of unforeseen elements making it more expensive than less expensive.

Improvements on directional drilling as well as approval of stronger materials can have a larger cost impact on the installation cost.

The uncertainty on specific safety requirements will add some uncertainty to the cost estimates. Especially approvals, expropriation, cost due to resistance (especially in larger cities) is very difficult to estimate.

Quantitative description

See separate Excel file for Data sheet

132 Transport by road

This catalogue includes transport of H₂, NH₃, DME and LHC by truck. Typical operation conditions for the transport is given in Table 31.

Brief technology description

The advantage of road transportation is the flexibility and ability to collect and deliver at almost any location as well as low CAPEX. Road truck is more suitable for relatively short distances and for smaller volumes.

Trucks and trailers

Different designs of trucks and trailers are available depending if they are intended for bulk transport (large quantities from point A to point B) or distribution transport (small quantities to many costumers e.g. tank stations).



Figure 16: a) Tank, b) trailer, and c) tank trailer (semi-trailer)

The maximum permissible weight of lorries in Denmark is given in Table 30.

Weight per non-drive axle	Weight per drive axle	Truck 2 axles	Truck 3 axles	Truck 4 axles	Road train 4 axles	Road train 5 axles	Road train 6 axles	Road train 7 axles
10 t	11.5 t	18 t	24 t	32 t	38 t	44 t	50 t	56 t

Table 41: Permissible maximum weight of lorries in Denmark¹⁵ (in ton).

¹⁵ Bekendtgørelse om køretøjers største bredde, længde, højde, vægt og akseltryk, BEK nr 1497 af 01/12/2016

Tank types

Table 31 gives an overview of different types of truck-tanks and their associated cost (both CAPEX and variable operation cost).

Figure Below	Fluid	Tank types	T, °C	P, barg	Capacity (typical)	Further info	CAPEX Truck & trailer, M€
A, B C	LHC	Non pressured Liquid tank	Amb.	0.2-3.5	20-35 m ³ 15-35 t	Single wall, Aluminum, CS Double wall, poison or corrosive fluid, Corrosive: SS, lined with rubber or plastic	0.46 (LHC)
D	LPG, DME,	Compressed liquid tank	Amb.	5-35	13-45 m ³ 7-30 t	Single wall, Carbon steel	0.70 (LPG & NH ₃ & DME)
E	NH ₃	Refrigerated liquid tanks	-50-(-90)	1.5-35	Up to 50 m ³ (<31 t)	Double walled with vacuum between, Boil-off loss	
F	H ₂ , NG	Compressed gas tanks (CH ₂ , CNG)	Amb.	275-500	Up to 50 m ³ (<13 t LNG) (<1.5 t LH ₂)	Multiple tubes, each with a PSV. See Figure 17	0.98 (CH ₂)
E		Cryogenic tank (LH ₂ , LNG)	Down to -253 (H ₂) -165 (NG)	6-350	Up to 50 m ³ (<33 t LNG) (<3.5 t LH ₂)	Double walled with vacuum between, Boil-off loss	0.61 (LH ₂)

Table 42: Different types of tankers for fuel transport ref. 22.

Tank trailers can be divided into the following categories:

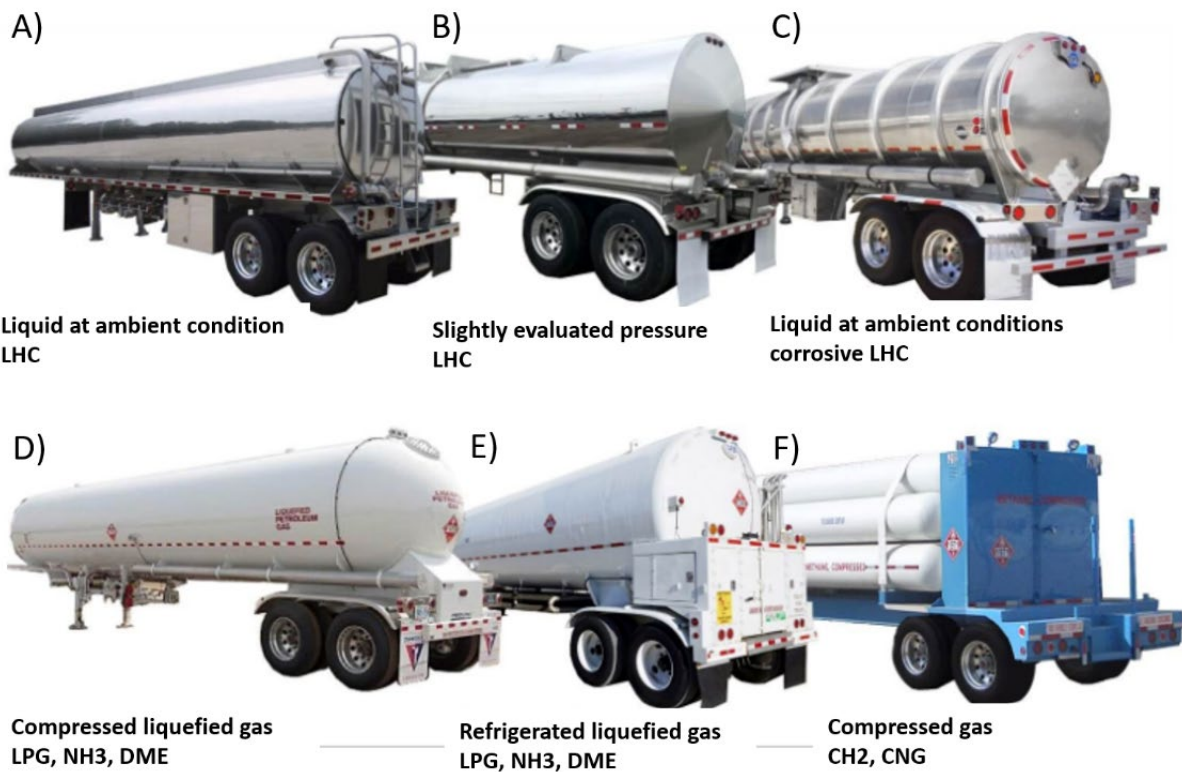

Figure 17: Different tank trailer design [ref. 22].

Hydrogen tanks can be categorized in type I-IV (see chapter about hydrogen storage in ref. 7). The type IV tanks seem to be more favorable for transportation due to the lower cylinder weight and no risk of corrosion.



Figure 18: Hydrogen tube trailer types

Tank design includes various safety functions (see figure below). Among these is division into several compartments to reduce the fluctuations/sloshing of the liquid in the tank. Additionally, a safety system that prevents overfilling of the tank is mandatory as well as it is important to inspect valves and tank for leaks before and after loading.

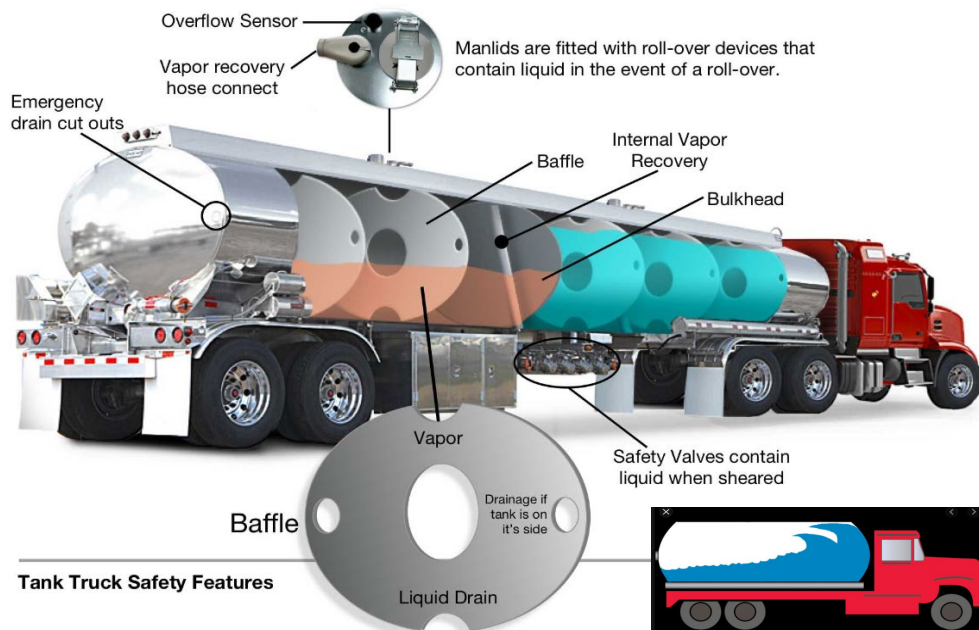

Figure 19: Tank safety features and internal baffles to prevent liquid splashing when driving.

Input

Input is:

1. fuel to be transported
2. fuel for propulsion (see consumption in section *Energy losses*)
3. fuel for keeping transported fuel cold (only for L20, H2NG)

Point 3 is normally not used. Instead, some boil-off is accepted. This boil-off can be minimized by using the boil-off as fuel for propulsion.

Typically transport pressure and temperature is given in Table 2, Table 31 and Table 32.

Loading system:

Fuel to be transported is loaded into the truck via filling compressor/pump and some loading system (typically via a loading arm). Thus, a loading station normally comprise:

1. Storage tanks (see cost in section *Storage tanks*) and associated moat
2. Filling compressor/pump (see cost in *Conversion to/from carrier (LOHC), Compressor and Pumps*)
3. Loading arms (cost is ~25-35 k€)
4. Fundament, piping, drip trays, various safety equipment

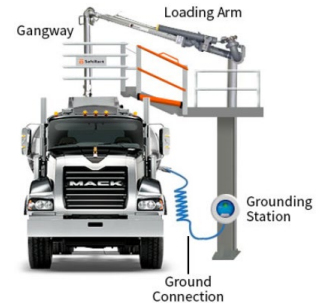

Figure 20: Loading arm

Loading system is not included in the datasheet as this cost depend strongly on location and how many that share the same loading equipment.

The time used for loading is included in the cost calculations.

Output

The output is the fluid that has been transported. Normally it will be the same input. Exception is boil-off (see *Energy losses*).

Unloading system:

The unloading system normally comprise:

1. Storage tanks (see cost in *Storage tanks*)
2. Unloading via gravity (only possible for liquids) or via compressor/pumps (see cost in *Conversion to/from carrier (LOHC), Compressor and Pumps*)
3. Fundament, piping, drip trays, various safety equipment

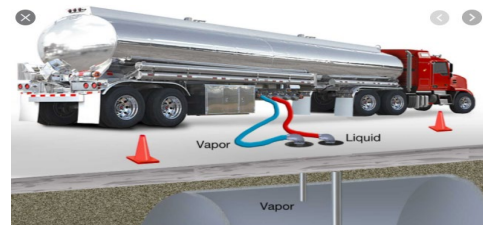

Figure 21: Unloading into storage tank via gravity

For liquid fuels, the fuel is normally unloaded via gravity (see Figure 20) or via a pump.

For compressed gas (CH₂ and CNG), gravity cannot be used. To limit the compression loss, it is optimal if the trailer tubes is used as final storage vessels (see Figure 21).



Figure 22: Trailer and storage is same vessel.

For the same reason given for the loading system, the unloading system has not been included in the cost estimate in the datasheet.

Efficiency and losses

Energy losses during transportation with truck include fuel for propulsion, both to the actual transport as well as the transport back of an empty truck, and boil off (see section *Energy losses*).

Application potential

Road truck transport of compressed gas (H₂ and NG) is generally only optimal for small volumes over limited distances.

For liquids, the volumetric energy density is much higher meaning much more energy can be transported per tour. Additionally, the filling and unloading system is much simpler and therefore inherit less losses. Thus, truck is generally optimal also for larger quantities.

Typical capacities

Typical capacities of trucks are given in Table 32. Datasheets for the following have been included in this catalogue:

Fluid	Net Truck		P bar	T °C
	Mass, tons	Energy, GJ		
CH ₂	1.5	180	350 - 500	Ambient
LH ₂	3.1	383	6 - 350	Down to -253
NH ₃	28	532	20 - 35	Ambient
DME	31	887		
Toluene	44	1766	1.2 - 4.5	Ambient

Table 43: Typical capacities and condition of tankers for liquid/gas transport

Environmental

As with all other trucks, environmental challenges are:

1. GHG and particle emissions
2. Noise pollution
3. Impact on landscape and habitats from infrastructure

Research and development perspectives

Truck transportation is a well-proven mature technology (TRL=8-9).

Cost reduction improvements may include

1. Reduce the boil off – possible to improve the insulation
2. Improvement of the hydrogen trailer tubes: Lowering the weight of pressured tanks by developing stronger, lighter and cheaper composite materials will reduce transportation costs dramatically
3. Mass production of the hydrogen trailer tubes
4. Standardize the hydrogen trailer tubes so they are incorporated as storage vessels at the production and at the destination units

5. Reduce the loading/unloading time (for CH₂, possible use the same vessels for storage and transportation)

Prediction of performance and costs

An estimate for transportation by truck as function of capacity and distance has been derived:

$$\text{Cost} = \text{VariableCost} \cdot \text{Distance} + \text{FixedCost}$$

The variable cost (VariableCost) include fuel consumption, driver wage and degradation due to usage (the latter is estimated by multiplying "CAPEX + O&M" with time fraction it is driving).

The fixed cost (FixedCost) include wage for supervision and the remaining "CAPEX + O&M".

In the calculation of a cost factors the following is assumed:

1. CAPEX of trailer truck used is given in Table 31
2. Annual Fixed O&M is set to 5% of CAPEX
3. Loading/unloading time used is given in Table 33
4. Availability is set to 8000 h per year
5. Driver cost is 45 EUR/h (operation 24/7).
6. Fuel consumption (MJ/km) used is listed in *Energy losses* and fuel cost is 29 EUR/kJ.
7. Average speed is 60 km/h.
8. Truck CAPEX is annualized with 5% interest over 6 years (assumed lifetime).

With the above assumptions the cost of NH₃ transport is modelled by:

$$\text{Cost} = 4.5 \frac{\text{€}}{\text{t NH}_3} + \text{Distance} \cdot 0.13 \frac{\text{€}}{\text{t NH}_3 \cdot \text{km}}$$

Example of cost of transport

Based on the above, cost for 30 and 100 km drive are estimated:

Fluid	Loading/ unloading hours, 2020/2030/2050	Reference	FixedCost €/t	Variable Cost €/(t*km)	Total 30 km €/t	Total 100 km €/t
LH2	5/4/3	*	37	1.1	71	149
CH2	4.25/4/3	**	132	2.6	211	396
NH3	3/2.5/2	***	4.5	0.13	8	17
DME	/2.5/2/2	****	3.7	0.12	7	16
Toluene	/2.5/1.5/1.5	****	2.1	0.08	5	10

Table 44: Typical values obtained from *Air liquid A/S, **Everfuel A/S, ***Give Svaergods A/S & ****Fjellerad Transport Aps (values for LPG and Diesel is used). Values are for 2020.

Uncertainty

Transport of LHC are a mature technology, i.e. little uncertainty is assumed.

Transport of L20 (i.e. NH₃, DME and LPG) is also mature, especially LPG. NH₃ is very toxic and a little higher uncertainty to the high end have been added.

For LH2 and CH₂ high uncertainty is added, especially to future values as major improvements are expected (see section *Research and development perspectives*) but unsure.

Quantitative description

See separate Excel file for Data sheet

133 Transport by ship

Brief technology description

NH₃

LNG



LH2 (future)

Ship and tank types

For ship transport, only liquid transport exist, most likely because they are not economically favourable due to low volumetric energy density and requirement to very high vessel wall thickness. Thus, only moderate pressure levels (<20 bar) exist, i.e. it is not possible to transport H₂ and NG as compressed gases. However, there exist development projects that look at marine transport of CNG [ref. 11] and marine transport of LH2 [ref. 25].

Liquid/gas transporting ships can be divided into the following types:

Fluid	Tank types (fluid phase)	T, °C	P, barg	Tank Class	Capacity (typical), m ³	Ships today	CAPEX M€
LHC	Oil tankers (LHC)	Amb.	Atm.	Integral	3,000-120,000	800	31 ¹⁶ (50,000 m ³)
LPG	Full refrigerated	-48	Atm.	A	15,000-200,000	Almost 300	79 ¹⁸ (80,000 m ³)
DME	(refrigerated liquefied gas)						
NH ₃ ¹⁷	Semi-refrigerated (refrigerated + comp. liquefied gas)	-10	4-17	C	6,000-12,000		
	Pressurized (compressed liquefied gas)	Amb	≥17 ¹⁹	C	1,000-3,000	300	
LNG	Cryogenic cooling	-165	Atm.	A, B, M	40,000 – 135,000	500	155 ²⁰ (145,000 m ³)
LH2 ²¹	Cryogenic cooling	-253	Atm.	?	1,250	1 (expected in end of 2020)	

Table 45: Different types of tankers for liquid/gas transport

The tanks can be either integral part of the ship structure or an independent self-supported tank. The independent tanks can be divided into:

1. Class A tanks – prismatic free-standing tanks: Pd < 700 mbar g.
2. Class B tanks – spherical shape: Pd < 700 mbar g.
3. Class C tanks – cylindrical or bilobe shape: Pd > 2 bar g

¹⁶ BRS group annual review 2019

¹⁷ Other fluids that can be transported via LPG tankers: Ethylene (full and semi refrigerated), Propane, Butane and Propylene.

¹⁸ <https://www.seatrade-maritime.com/tankers/euronav-buys-another-scrubber-fitted-resale-vlcc-newbuild>

¹⁹ Correspond to vapor pressure of LPG at ~45°C.

²⁰ Danish Ship Finance, Shipping market review 2019

²¹ https://global.kawasaki.com/en/corp/newsroom/news/detail/?f=20191211_3487

4. Membrane tanks (M)

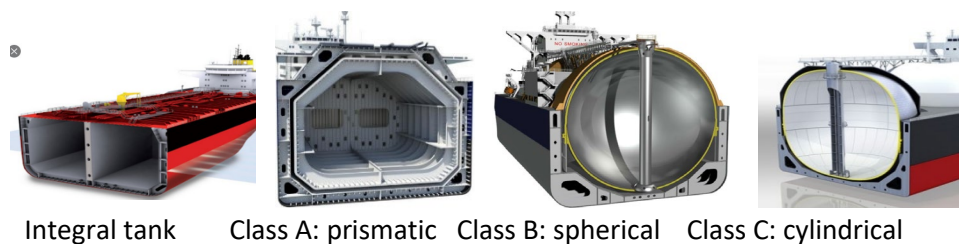

Figure 23: Different tank classes. The most cost-efficient onboard storage of ammonia seems to be class C (pressurized tanks) (Topsoe, 2020).

Max size of ships are given by the following classes:

Max size class	Max Length m	Max Beam m	Max Draft m	Max dead weight ton (DWT)	Application/info
Coastal Tanker	205 m	29 m	16 m	50,000	mainly used for transportation of refined products
Aframax	245 m	34 m	20 m	80,000	AFRA (Average Freight Rate Assessment)
Suezmax	285 m	45 m	23 m	125,000-180,000	Originally the max. capacity of the Suez Canal.
Very large crude carrier (VLCC)	330 m	55 m	28 m	320,000	Oil tankers
Ultra large crude carrier (ULCC)	415 m	63 m	35 m	550,000	Oil tankers

Table 46: Tanker size classes

Reliquification onboard

The semi-pressurized and fully refrigerated carriers can be provided with reliquification which reliquify any boil-off produced during loading and operation and return it to the tanks.

Input

Input is the fluid to be transported and the fuel used to sail the ship.

Fuel to be transported:

The terminal will consist of storage tanks with capacity typically 120-150% of the ship's capacity. Loading system will normally be designed for ~10h loading. Fuel is typically loaded with loading arms or flexible hoses.

If refrigerated/cryogenic liquefied fluid, the loading system/tanks must either be precooled or loaded slow (see section [Loading/unloading](#)). Any generated vapor must be re-liquefied (require specific re-liquefied system) or vented (boil-off).

Fuel used to drive the ship:

Fuel consumption for propulsion is described in [Energy losses](#).

Output

The output is the fluid that have been transported. Normally it will be the same input. Exception is boil-off (see section *Energy losses*).

As all ship transport is transporting liquid fuels, unloading will be via pump. The tank pressure will fall as liquid is removed. If the unloading rate is high there may be insufficient boil-off to maintain positive pressure in the tank, and blanketing gas must be added to prevent a vacuum.

Efficiency and losses

Energy losses during the transportation with ship include fuel consumption, both to the actual transport as well as the transport back of an empty truck, and boil off (see *Energy losses*).

Application potential

Ships will be applicable for point to point transportation.

Ship transportation requires a certain minimum volume and distance to be economically favorable compared to the alternatives (pipeline and road transport).

Typical capacities

Typical capacities of ships are given in Table 36.

Fluid	Net Ship		Pd barg	Td °C
	Mass, tons	Energy, GW		
LH2	10.000*	345	Ambient	-253
NH ₃	45.000	240	Ambient	-48
DME	45.000	366	Ambient	-48
Toluene	45.000	508	Ambient	Ambient

Table 47: Typical capacities of tankers for liquid/gas transport. * No liquid H₂ carriers are developed, so the numbers are based on an LNG carrier.

Environmental

The environmental impact of ship transport is mainly due to the emissions from the ship doing propulsion.

Maritime transport account to 2-3 % of the total global CO₂ emission.

The IMO's (International Maritime Organization) Marine Environment Protection Committee (MEPC) have introduced the following to measures to reduce and control the GHG emission from ships:

1. The Energy Efficiency Design Index (EEDI) which set minimum energy efficiency performance levels for new ships
2. The Ship Energy Efficiency Plan (SEEMP) which set rules for improvement of energy efficiency of both new and existing ships

Additionally, MEOC have adopted GHG emission goals of 50% reduction by 2050 compared to 2008. Finally, several initiatives are under way for environmental classifications of ships.²²

Other environmental challenges

1. Ship recycling
2. Ballast water management
3. Hull fouling
4. Waste management

Research and development perspectives

Liquid carriers are a proven commercial technology except for LH2. For LH2 TRL=5 while for the other it is 9.

Reduce GHG emission: Completely carbon-free NH₃ fueling engines are under development and is expected to be ready in 2023-24. Today, it is prohibited to use toxic products, i.e. ammonia, as fuels for ships, thus, amendment to the International code for safety for ships is required.

Much research is conducted in reducing fuel consumption by for example reducing the hull resistance by air lubrication, new designs of the bulbous bow, new hull coatings and improving propulsion.

Developing LH2 technology for transport of liquid hydrogen by ship.

Prediction of performance and costs

Investment cost (CAPEX)

Based on the cost examples given in Figure 23 the red approximation seems valid for L20 fuels (LPG, DME, NH₃ (and CO₂)).

$$\text{CAPEX} = 4000 - 0.05 * M_{\text{cargo}}$$

Where M_{cargo} is the weight of the fuel transported. CAPEX for LHC is based value are listed in Table 34 (equal to the green point in Figure 23). For LH2, an obtained cost for LNG is used Table 34 as no LH2 ships are constructed yet. LH2 ship is expected to be slightly more expensive than LNG ships as more extreme cooling is needed, i.e. more insulation is expected to minimize heat interaction with surrounding. Alternatively, more boil off loss will exist.

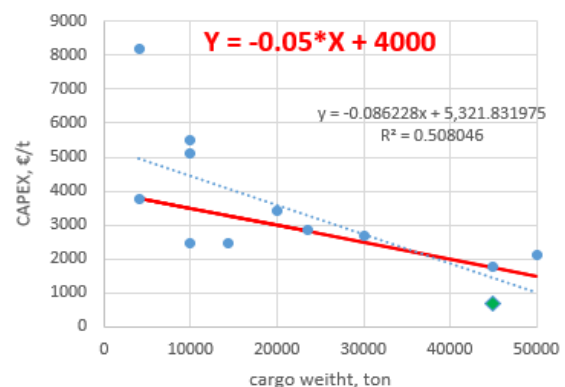

Figure 24: CAPEX of L20 ships (including CO₂ carrying ships) vs cargo weight from various obtained examples (green point is price for diesel tanker which is cheaper as no pressure or refrigerated vessels)

²² Environmental Classifications of Ships, Miljøstyrelsen 2014.

Fixed O&M

Crew wages, maintenance, administration, tax and insurance, canal dues, tugs, pilotage (normal initial value is ~5% of CAPEX²³).

Port cost

Port cost have been estimated based on 2 days duration in port in both end and tariff for Port of Rotterdam (expensive end) have been applied.

Energy demand

Fuel consumption is estimated using Equation 1 (see *Energy losses*). The following three cases are listed in the datasheet:

1. LHC: 50000 m3 MR2 tanker with a cargo fuel weight of ~45,000 t.
2. L20: 80000 m3 VLGC tanker with a cargo fuel weight of ~45,000 t.
3. LH2: 145000 m2 LNG tanker with a cargo LH2 fuel weight of ~10,000 t.

Uncertainty

The uncertainty related to the costs for transporting hydrogen are substantial, since hydrogen carriers has not yet been built and the cost therefore is based on cost for LNG.

Quantitative description

See separate Excel file for Data sheet

²³ Shipping CO2 – UK Cost Estimation Study, November 2018

References

- 1 AL. (2005). *Questions and Issues on Hydrogen PipeLine*. Retrieved from https://www.energy.gov/sites/prod/files/2014/03/f10/hpwgw_questissues_campbell.pdf
- 2 ANL. (2007). Overview of interstate hydrogen pipeline systems. Argonne national laboratory
- 3 Between the Poles; Excavation damage remains a leading cause of serious pipeline accidents; [Between the Poles: Excavation damage remains a leading cause of serious pipeline accidents \(blogs.com\)](#)
- 4 Campanella, C. (n.d.). Lake Pontchartrain. <https://books.google.dk/books?id=tP90BgAAQBAJ&pg=PA64&lpg=PA64&dq=hydrogen+pipe++Plaquemine+to+Chalmette&source=bl&ots=TWu5d8MDNj&sig=ACfU3U0NHp-n6F2JydmgZnS0587fDJCbCQ&hl=da&sa=X&ved=2ahUKEwisk4W-zLjqAhVxpIsKHfMKD9QQ6AEwAHoECB8QAQ#v=onepage&q=hydrogen%20>
- 5 Chatzimarkakis, J. (2020). Green hydrogen for european green deal, A 2*40 GW initiative. Hydrogen Europe.
- 6 EIGA. (2014). Hydrogen pipeline systems, IGC Doc 121/14.
- 7 ENS. (2018). Technology Data - Energy storage. DK.
- 8 Enogas, Energinet, Fluxys Belgium, Gasunie, GRTgaz, NET4GAS, OGE, ONTRAS, Snam, Swedegas, Teroga; European hydrogen backbone; 2020; [European Hydrogen Backbone - Gas for Climate 2050](#)
- 9 FertilizerEurope. (2014). *Guidance for transporting ammonia by rail*. Fertilizer europe. Retrieved from https://www.fertilizerseurope.com/wp-content/uploads/2019/08/Guidance_for_transporting_ammonia_in_rail_4.pdf
- 10 Franco A., Casarosa G. (2014); Thermodynamic and heat transfer analysis of LNG energy recovery for power production; <https://iopscience.iop.org/article/10.1088/1742-6596/547/1/012012/pdf>
- 11 Interaction International; Maritime & Mercantile Group of Companies; From shore to ship – CNG marine transportation; [From shore to ship – CNG marine transportation \(interactionintltd.com\)](#)
- 12 Jiri Pospisil (2019); Energy demand of liquefaction and regasification of natural gas and potential LNG for operative thermal energy storage; <https://www.sciencedirect.com/science/article/abs/pii/S1364032118306828#f0080>
- 13 Jørgensen, N. (X). Risiko ved transport af farligt gods. Banestyrelsen.

- 14 KEBS. (2019). Anhydrous Ammonia-Storage and handling. KENYA Standard.
- 15 Kennedy, E. (2019). *Hydrohub HyChain 3*. Amersfoort, NL: Institute of sustainable process technology.
- 16 Marcogaz. (2019). Overview of available test results and regulatory limits for hydrogen admission into existing natural gas infrastructure and end use. Marcogaz.
- 17 Marine, I. (2020). *Understanding the design of liquefied gas carriers*. Retrieved from Marine insight: <https://www.marineinsight.com/naval-architecture/understanding-design-liquefied-gas-carriers/>
- 18 NEL. (1998). Cost of hydrogen storing and transporting hydrogen.
- 19 NREL. (2012). Hydrogen infrastructure cost estimate and blending hydrogen into natural gas pipelines. National renewable energy laboratory (NREL).
- 20 NREL. (2014). Hydrogen Station Compression, Storage, and Dispensing; Technical Status and Costs.
- 21 NTM. (2020). *Network for transport measures*. Retrieved from <https://www.transportmeasures.org/en/wiki/evaluation-transport-suppliers/>
- 22 Planetforlife: Hydrogen for transport and the B&E report (2004); [Hydrogen for Transport \(planetforlife.com\)](http://planetforlife.com)
- 23 SafeRack. (X). *SafeTack*. Retrieved from Tuel transport safety - truck tanker types: <https://www.saferack.com/glossary/cargo-tanks-transport-safety/>
- 24 Tennet, G. (2020). *Infrastructure outlook 2050*. Gasunie and Tennet.
- 25 The Maritime Executive; Concept Design for World's first compressed hydrogen carrier ship; [Concept Design for World's First Compressed Hydrogen Carrier Ship \(maritime-executive.com\)](http://maritime-executive.com)
- 26 Topsoe. (2020). Ammonfuel - an industrial view of ammonia as a marine fuel. Topsoe.
- 27 TWI. (X). *What is hydrogen embrittlement - causes, effect and prevention*. TWI. Retrieved from <https://www.twi-global.com/technical-knowledge/faqs/what-is-hydrogen-embrittlement>
- 28 US Department of Energy; Potential Roles of Ammonia in a hydrogen economy; A study of issues related to the use of Ammonia for On-Board Vehicular Hydrogen storage; <https://www.google.com/url?sa=t&rct=j&q=&esrc=s&source=web&cd=&ved=2ahUKEwjwyJ26mc7uAhVJw4sKHTPkDC8QFjABegQIARAC&url=https%3A%2F%2Fwww.e>

[nergy.gov/sites/prod/files/2015/01/ff19/ffcto_nh3_h2_storage_white_paper_2006.pdf&usg=AOvVaw3g09VBpS1Zic7rgAX84dc6](https://www.energy.gov/sites/prod/files/2015/01/ff19/ffcto_nh3_h2_storage_white_paper_2006.pdf&usg=AOvVaw3g09VBpS1Zic7rgAX84dc6)

- 29 US-OSHA. (X). *Properties of ammonia*. Retrieved from United states department of labor, Occupational Safety & Health administration:
https://www.osha.gov/SLTC/etools/ammonia_refrigeration/ammonia/
- 30 Wiki. (2020 H2pipe). *Hydrogen pipeline transport*. Retrieved from
https://en.wikipedia.org/wiki/Hydrogen_pipeline_transport
31. Zhang, X. (2015). Towards a smart energy network: The roles of fuel/electrolysis cels and technological perspectives.
https://www.researchgate.net/publication/275462874_Towards_a_smart_energy_network_The_roles_of_fuelectrolysis_cells_and_technological_perspectives/figures?lo=1