

# Technology Data

## Generation of Electricity and District heating



Energistyrelsen  
Danish Energy Agency

Technology descriptions  
and projections for long-term  
energy system planning

### **Technology Data - Energy Plants for Electricity and District heating generation**

First published August 2016 by the Danish Energy Agency and Energinet,

E-mail: [teknologikatalog@ens.dk](mailto:teknologikatalog@ens.dk), Internet: <http://www.ens.dk/teknologikatalog>

Production: Danish Energy Agency

Front page design: Filip Gamborg

Front cover photo: Avedøre Power station and 3.6 MW offshore wind turbine / Lars Brømsøe Termansen

Version number: 0013

## Amendment sheet

### Publication date

Publication date for this catalogue “Technology Data for Energy Plants” is august 2016. In June 2017 this amendment sheet has been added and also the possibility to add descriptions of amendments in the individual chapters if required. Hereby the catalogue can be updated continuously as technologies evolve, if the data changes significantly or if errors are found.

The newest version of the catalogue will always be available from the Danish Energy Agency’s web site.

### Amendments after publication date

All updates made after the publication date will be listed in the amendment sheet below.

| Version     | Date          | Ref.                           | Description  |
|-------------|---------------|--------------------------------|--|
| 0013        | Februar 2023  | 08 WtE DHP and HOP plants      | Updated info on operation of Amager Bakke power plant  |
| <b>0012</b> | June 2022     | 45 Geothermal district heating | Updated with large-scale geothermal systems  |
| <b>0012</b> | June 2022     | 40 Heat pumps                  | Seawater heat pump updated with infrastructure costs and seawater CO <sub>2</sub> heat pump added  |
| <b>0011</b> | March 2022    | 21 Wind Turbines, Offshore     | Technology description revised and updated<br>Updated data sheets for offshore wind turbines and nearshore wind turbines   |
| <b>0010</b> | February 2022 | 22 Photovoltaics               | Technology description revised and updated<br>Updated data sheets for small (residential) and medium (commercial/industrial) rooftop PV, and large utility scale fixed and single axis tracking PV |
| <b>0009</b> | April 2020    | 45 Geothermal district heating | Updated qualitative description and datasheets. Datasheets now divided in 1200 m and 2000 m depth, electric- and absorption heat pumps and 2 different district heating temperatures.              |
| <b>0009</b> | April 2020    | 40 Heat pumps                  | Updated qualitative description and datasheets. Datasheets now divided in 3 types and different plant sizes  |
| <b>0009</b> | April 2020    | Guideline                      | Assumed full load hours for heat pumps changed from 4000 to 6000   |
| <b>0008</b> | March 2020    | 09 Biomass section             | Medium and Large scale wood chips boilers added.<br>Text revised to incorporate new larger boilers.<br>Revision of ash-content and lower heating value for wood chips.                             |

|             |               |  |   |
|-------------|---------------|--|---|
| <b>0007</b> | January 2020  | 09 Biomass CHP and HOP plants  | Addition of extraction units in qualitative- and quantitative description   |
| <b>0007</b> | January 2020  | 08 and 09 Biomass and waste chapters   | Revised qualitative- and quantitative description. Among adjustments in datasheets are efficiencies, distribution between variable and fixed O&M and notes<br><br>Addition of 50/100 °C datasheets for large backpressure units   |
| <b>0007</b> | January 2020  | Introduction, biomass and waste sections   | Text revised. PQ-diagrams for backpressure and extraction units added.  |
| <b>0006</b> | November '19  | 22 Photovoltaics   | Technology description revised and updated<br><br>Updated data sheet for large utility scale PV systems<br><br>New data sheet for large utility scale PV systems with single axis tracker<br><br>Updated description of losses of small and medium sized systems equivalent to data sheets of utility scale systems |
| <b>0005</b> | October '19   | 45 Geothermal district heating   | Heat pump included in financial data for geothermal plants  |
| <b>0004</b> | September '19 | 21 Wind turbines offshore  | Financial data (2050) and space requirements of nearshore wind datasheet corrected  |
| <b>0003</b> | June '19      | 03d Rebuilding coal plant to Biomass<br><br>03a-b Rebuilding coal plant to Biomass | Added Datasheet d for rebuild coal fired plants to chips backpressure plant<br><br>Updated datasheets a and b for rebuild coal fired plants to wood pellets   |
| <b>0002</b> | May '19       | 20 Wind turbines onshore<br><br>21 Wind turbines offshore                          | Financial data (Investment cost and O&M) updated<br><br>Financial data (Investment cost and O&M) updated  |



|             |               |   |   |
|-------------|---------------|---|---|
|             |               | 45 Geothermal DH  | Variable O&M adjusted to include electricity consumption  |
| <b>0001</b> | Feb '19       | 45 Geothermal district heating  | Qualitative description and data sheet updated  |
| -           | November '18  | Introduction to Peak Power Plants and Reserve Technologies, 50 Diesel Engine Farm, 51 Natural Gas Engine Plant, 52 Open Cycle Gas Turbine | Chapters added  |
| -           | October '18   | 03 Rebuilding Large Coal Power Plants to Biomass  | Datasheets updated  |
| -           | October '18   | 07 CCS, 10 Stirling engines, 22 PV, 23 Wave energy, 45 Geothermal DH  | Chapters transferred from previous catalogue  |
| -           | October '18   | 46 Solar District Heating   | Qualitative description and datasheets updated  |
| -           | October '18   | 01 Advanced Pulverized Fuel Power Plant   | Qualitative description updated   |
| -           | September '18 | 08, 09, 42, 43, 99 Biomass and waste section  | Description of WtE (08) and Biomass (09) updated. CHP and HOP descriptions have been merged for WtE and Biomass respectively and Introduction, Biomass and Waste sections moved |
| -           | July '18      | 22 Photovoltaics  | Datasheets for small residential and medium commercial size systems updated   |
| -           | March '18     | 99 Introduction, Biomass and Waste sections   | Chapter added that gives a common introduction to the biomass and waste sheets ( chapter 08, 09, 42 and 43)   |
| -           | March '18     | 08,09,42,43 Waste and Biomass CHP and boilers   | Datasheet included, chapters will be included soon  |

|   |              |  |  |
|---|--------------|--|--|
| - | March '18    | 11 Solid oxide fuel cell CHP (Natural gas/biogas)                    | Chapter added  |
| - | March '18    | 12 Low temperature proton exchange membrane fuel cell CHP (hydrogen) | Chapter added  |
| - | January '18  | 05 Combined cycle gas turbine  | Additional references have been included                               |
| - | January '18  | 06 Gas engines   | Reference sheet have been updated                                      |
| - | January '18  | 40 Heat pumps, DH and 44 gas fired DH boiler                         | Updated prices for auxiliary electricity consumption in data sheet     |
| - | November '17 | 01 Advanced Pulverized Fuel Power Plant                              | Datasheet for Advanced Pulverized Fuel Power Plant - Coal CHP included |
| - | October '17  | 22 Photovoltaics   | Datasheet for large ground mounted PV plants included                  |
| - | June '17     | Preface  | Small changes explaining the amendment sheet                           |
| - | June '17     | 21 Wind Turbines Offshore  | Financial data (Investment cost and O&M) updated                       |
| - | June '17     | 41 Electric Boilers  | Revised chapter added  |

## Preface

The *Danish Energy Agency* publishes catalogues containing data on technologies for Energy Plants. This current catalogue includes updates of a number of technologies which replace the corresponding chapters in the previous catalogue published jointly by the Danish Energy Agency and Energinet, the Danish Transmission System Operator, in May 2012 with updates published in October 2013, January 2014 and March 2015. The intention is that all technologies in the previous catalogue will be updated and represented in this catalogue. Also the catalogue will continuously be updated as technologies evolve, if data change significantly or if errors are found. All updates will be listed in the amendment sheet on the previous page and in connection with the relevant chapters, and it will always be possible to find the most recently updated version on the Danish Energy Agency's website.

The primary objective of publishing technology catalogues is to establish a uniform, commonly accepted and up-to-date basis for energy planning activities, such as future outlooks, evaluations of security of supply and environmental impacts, climate change evaluations, as well as technical and economic analyses, e.g. on the framework conditions for the development and deployment of certain classes of technologies.

With this scope in mind, it is not the target of the technology data catalogues, to provide an exhaustive collection of specifications on all available incarnations of energy technologies. Only selected, representative, technologies are included, to enable generic comparisons of technologies with similar functions in the energy system e.g. thermal gasification versus combustion of biomass or electricity storage in batteries versus fly wheels.

Finally, the catalogue is meant for international as well as Danish audiences in an attempt to support and contribute to similar initiatives aimed at forming a public and concerted knowledge base for international analyses and negotiations.

## Data sources and results

A guiding principle for developing the catalogue has been to rely primarily on well-documented and public information, secondarily on invited expert advice. Where unambiguous data could not be obtained, educated guesses or projections from experts are used. This is done to ensure consistency in estimates that would otherwise vary between users of the catalogue.

Cross-cutting comparisons between technologies will reveal inconsistencies which may have several causes:

- Technologies may be established under different conditions. As an example, the costs of off-shore wind farms might be established on the basis of data from ten projects. One of these might be an R&D project with floating turbines, some might be demonstration projects, and the cheapest may not include grid connections, etc. Such a situation will result in inconsistent cost estimates in cases where these differences might not be clear.
- Investors may have different views on economic attractiveness and different preferences. Some decisions may not be based on mere cost-benefit analyses, as some might tender for a good architect to design their building, while others will buy the cheapest building.
- Environmental regulations vary from between countries, and the environment-related parts of the investment costs, are often not reported separately.
- Expectations for the future economic trends, penetration of certain technologies, prices on energy and raw materials vary, which may cause differences in estimates.
- Reference documents are from different years. The ambition of the present publication has been to reduce the level of inconsistency to a minimum without compromising the fact that the real world is ambiguous. So, when different publications have presented different data, the publication which appears most in compliance with other publications has been selected as reference.

In order to handle the above mentioned uncertainties, each catalogue contains an introductory chapter, stating the guidelines for how data have been collected, estimated and presented. These guidelines are not perfect, but they represent the best balance between various considerations of data quality, availability and usability.

## Danish preface

Energistyrelsen udarbejder teknologibeskrivelser for en række el- og varmeproduktionsteknologier. Dette nuværende katalog indeholder opdateringer af en stor del af teknologibeskrivelserne, som erstatter de tilsvarende kapitler i det gamle katalog, som tidligere blev udgivet i fællesskab mellem Energistyrelsen og Energinet i 2012 og senere opdateret i 2013, 2014 og 2015. Det er hensigten, at alle teknologibeskrivelserne fra det gamle katalog skal opdateres og integreres her. Desuden vil kataloget løbende opdateres i takt med at teknologierne udvikler sig, hvis data ændrer sig væsentligt eller hvis der findes fejl. Alle opdateringer vil registreres i rettelsesbladet først i kataloget, og det vil altid være muligt at finde den seneste opdaterede version på Energistyrelsens hjemmeside.

Hovedformålet med teknologikataloget er at sikre et ensartet, alment accepteret og aktuelt grundlag for planlægningsarbejde og vurderinger af forsyningsikkerhed, beredskab, miljø og markedsudvikling hos bl.a. de systemansvarlige selskaber, universiteterne, rådgivere og Energistyrelsen. Dette omfatter for eksempel fremskrivninger, scenarieanalyser og teknisk-økonomiske analyser.

Desuden er teknologikataloget et nyttigt redskab til at vurdere udviklingsmulighederne for energisektorens mange teknologier til brug for tilrettelæggelsen af støtteprogrammer for energiforskning og -udvikling. Tilsvarende afspejler kataloget resultaterne af den energirelaterede forskning og udvikling. Også behovet for planlægning og vurdering af klima-projekter har aktualiseret nødvendigheden af et opdateret databeredskab.

Endeligt kan teknologikataloget anvendes i såvel nordisk som internationalt perspektiv. Det kan derudover bruges som et led i en systematisk international vidensopbygning og -udveksling, ligesom kataloget kan benyttes som dansk udspil til teknologiske forudsætninger for internationale analyser og forhandlinger. Af disse grunde er kataloget udarbejdet på engelsk.



## Table of Contents

|   |     |
|---|-----|
| Introduction .....  | 11  |
| 01 Supercritical Pulverized Fuel Power Plant .....                        | 27  |
| 02 Life Time Extensions of Coal Power Plants .....                        | 40  |
| 03 Rebuilding Large Coal Power Plants to Biomass .....                    | 46  |
| 04 Gas Turbine, Simple-Cycle.....   | 61  |
| 05 Gas Turbine Combined-Cycle .....                                       | 69  |
| 06 Gas Engines.....   | 76  |
| 07 CO <sub>2</sub> Capture and Storage.....                               | 83  |
| Introduction to Waste and Biomass plants .....                            | 90  |
| 08 WtE CHP and HOP plants .....   | 106 |
| 09 Biomass CHP and HOP plants .....                                       | 127 |
| 10 Stirling engines, gasified biomass .....                               | 189 |
| 11 Solid oxide fuel cell CHP (natural gas/biogas) .....                   | 192 |
| 12 Low temperature proton exchange membrane fuel cell CHP (hydrogen)..... | 200 |
| 20 Wind Turbines onshore.....   | 205 |
| 21 Wind Turbines, Offshore.....   | 229 |
| 22 Photovoltaics .....  | 255 |
| 23 Wave Energy.....   | 278 |
| 40 Heat pumps .....   | 282 |
| 41 Electric Boilers .....   | 306 |
| 42 WtE HOP (go to chapter 08) .....                                       | 314 |
| 43 Biomass Fired HOP (go to chapter 09).....                              | 314 |
| 44 District Heating Boiler, Gas Fired .....                               | 315 |
| 45 Geothermal district heating.....                                       | 320 |
| 46 Solar District Heating .....   | 339 |

**Introduction to Peak Power Plants and Reserve Technologies.....355**

**50 Diesel Engine Farm.....362**

**51 Natural Gas Engine Plant .....369**

**52 Open Cycle Gas Turbine .....378**

**ANNEX 1: FEATURES OF STEAM EXTRACTION TURBINES .....389**

**ANNEX 2: Emissions limitations for peak- and reserve plants .....392**

## Introduction

This catalogue covers data regarding energy plants for generation of electricity and district heating. Three distinct categories of plants are included:

- **Heat-only generation:** technologies producing only heat to be provided to the district heating network (e.g. boilers and heat pumps);
- **Thermal electricity generation:** plants producing electricity with thermal processes (for example steam cycle or internal combustion engines), including combined heat and power plants (CHP).
- **Non-thermal electricity generation:** technologies producing electricity without thermal processes, such as wind power, solar power or hydroelectric power plants.

The main purpose of the catalogue is to provide generalized data for analysis of energy systems, including economic scenario models and high-level energy planning.

These guidelines serve as an introduction to the presentations of the different technologies in the catalogue, and as instructions for the authors of the technology chapters. The general assumptions are described in the section below. The following sections (1.2 and 1.3) explain the formats of the technology chapters, how data were obtained, and which assumptions they are based on. Each technology is subsequently described in a separate technology chapter, making up the main part of this catalogue. The technology chapters contain both a description of the technologies and a quantitative part including a table with the most important technology data.

### General assumptions

The boundary for both cost and performance data is the generation assets plus the infrastructure required to deliver the energy to the main grid. For electricity, this is the nearest land-based substation of the transmission/distribution grid, while district heat is delivered to the nearest district heating network. In other words, the technologies are described as they are perceived by the electricity or district heating systems receiving their energy deliveries. Thus, stated capacities are net capacities, which are calculated as the gross generation capacity minus the auxiliary power consumption “capacity” at the plant. Similarly, efficiencies are also net efficiencies.

Unless otherwise stated, the thermal technologies in the catalogue are assumed to be designed and operated for approx. 4000-5000 full load hours annually. 75 % of generation is expected to take place in full load and the remaining 25 % in part load. Some of the exceptions are municipal solid waste incineration facilities and stand-alone biogas plants, which are designed for continuous operation, i.e. approximately 8000 full load hours annually. The assumed numbers of full load hours are summarized in table 1.

For electricity and heat production technologies dependent on wind and solar resources, estimates of annual full load hours of production are made for each technology.

|  | Full load hours<br>(electricity) | Full load hours<br>(heat) |
|--|----------------------------------|---------------------------|
| CHP back pressure units                    | 4000                             | 4000                      |
| CHP extraction units                       | 5000                             | 4000                      |
| Municipal solid waste / biogas stand alone | 8000                             | 8000                      |
| Boilers                                    |                                  | 4000                      |
| Geothermal heat and heat pumps             |                                  | 6000                      |
| Electric boilers                           |                                  | 500                       |

Table 1: Assumed number of full load hours.

### 1.2. Qualitative description

The qualitative description describes the key characteristics of the technology as concise as possible. The following paragraphs are included where relevant for the technology.

#### Contact information

Containing the following information:

- Contact information: Contact details in case the reader has clarifying questions to the technology chapters. This could be the Danish Energy Agency, Energinet (as the previous joint publisher) or the author of the technology chapters.
- Author: Entity/person responsible for preparing the technology chapters
- Reviewer: Entity/person responsible for reviewing the technology chapters.

#### Brief technology description

Brief description for non-engineers of how the technology works and for which purpose.

An illustration of the technology is included, showing the main components and working principles.

#### Input

The main raw materials and primarily fuels, consumed by the technology.

#### Output

The forms of generated energy, i.e. electricity and heat, and any relevant by-products.

#### Typical capacities

The stated capacities are for a single unit capable of producing energy (e.g. a single wind turbine or a single gas turbine), not a power plant consisting of a multitude of unit such as a wind farm.

In the case of a modular technology such as PV or solar heating, a typical size of a solar power plant based on the market standard is chosen as a unit. Different sizes may be specified in separated tables, e.g. Small PV, Medium PV, Large PV.

#### Space requirement

Space requirement is expressed in 1000 m<sup>2</sup> per MW. The value presented only refers to the area occupied by the facilities needed to produce energy.

In case the area refers to the overall land use necessary to install a certain capacity, or a certain minimum distance from dwellings is required, for instance in case of a wind farm, this is specified in the notes. The space requirements may for example be used to calculate the rent of land, which is not included in the financial cost, since this cost item depends on the specific location of the plant.

#### Regulation ability and other power system services

Regulation abilities are particularly relevant for electricity generating technologies. This includes the part-load characteristics, start-up time and how quickly it is able to change its production when already online.

If relevant, the qualitative description includes the technology's capability for delivering the following power system services:

- Inertia
- Short circuit power
- Black start
- Voltage control



- Damping of system oscillations (PSS)

### Advantages/disadvantages

A description of specific advantages and disadvantages relative to equivalent technologies. Generic advantages are ignored; e.g. renewable energy technologies mitigating climate risks and enhance security of supply.

### Environment

Particular environmental characteristics are mentioned, for example special emissions or the main ecological footprints.

The energy payback time or energy self-depreciation time may also be mentioned. This is the time required by the technology for the production of energy equal to the amount of energy that was consumed during the production and the installation of the equipment.

### Research and development perspectives

This section lists the most important challenges to further development of the technology. Also, the potential for technological development in terms of costs and efficiency is mentioned and quantified if possible. Danish research and development perspectives are highlighted, where relevant.

### Examples of market standard technology

Recent full-scale commercial projects, which can be considered market standard, are mentioned, preferably with links. A description of what is meant by “market standard” is given in the introduction to the quantitative description section. For technologies where no market standard has yet been established, reference is made to best available technology in R&D projects.

### Prediction of performance and costs

Cost reductions and improvements of performance can be expected for most technologies in the future. This section accounts for the assumptions underlying the cost and performance in 2015 as well as the improvements assumed for the years 2020, 2030 and 2050. For new chapters published or updated after 2020, 2020 serves as base year for the technology instead of 2015.

The specific technology is identified and classified in one of four categories of technological maturity, indicating the commercial and technological progress, and the assumptions for the projections are described in detail.

In formulating the section, the following background information is considered:

#### *Data for 2015*

In case of technologies where market standards have been established, performance and cost data of recent installed versions of the technology in Denmark or the most similar countries in relation to the specific technology in Northern Europe are used for the 2015 estimates. For updates after 2020, 2015 is replaced by 2020.

If consistent data are not available, or if no suitable market standard has yet emerged for new technologies, the 2015 (or 2020) costs may be estimated using an engineering based approach applying a decomposition of manufacturing and installation costs into raw materials, labor costs, financial costs, etc. International references such as the IEA, NREL etc. are preferred for such estimates.

#### *Assumptions for the period 2020 to 2050*

According to the IEA:

*“Innovation theory describes technological innovation through two approaches: the technology-push model, in which new technologies evolve and push themselves into the marketplace; and the market-pull model, in which a market opportunity leads to investment in R&D and, eventually, to an innovation” [6].*

The level of “market-pull” is to a high degree dependent on the global climate and energy policies. Hence, in a future with strong climate policies, demand for e.g. renewable energy technologies will be higher, whereby innovation is expected to take place faster than in a situation with less ambitious policies. This is expected to lead to both more

efficient technologies, as well as cost reductions due to economy of scale effects. Therefore, for technologies where large cost reductions are expected, it is important to account for assumptions about global future demand.

The IEA's New Policies Scenario provides the framework for the Danish Energy Agency's projection of international fuel prices and CO<sub>2</sub>-prices, and is also used in the preparation of this catalogue. Thus, the projections of the demand for technologies are defined in accordance with the thinking in the New Policies Scenario, described as follows:

*"New Policies Scenario: A scenario in the World Energy Outlook that takes account of broad policy commitments and plans that have been announced by countries, including national pledges to reduce greenhouse gas emissions and plans to phase out fossil energy subsidies, even if the measures to implement these commitments have yet to be identified or announced. This broadly serves as the IEA baseline scenario" [7].*

Alternative projections may be presented as well relying for example on the IEA's 450 Scenario (strong climate policies) or the IEA's Current Policies Scenario (weaker climate policies).

### *Learning curves and technological maturity*

Predicting the future costs of technologies may be done by applying a cost decomposition strategy, as mentioned above, decomposing the costs of the technology into categories such as labor, materials, etc. for which predictions already exist. Alternatively, the development could be predicted using learning curves. Learning curves express the idea that each time a unit of a particular technology is produced, learning accumulates, which leads to cheaper production of the next unit of that technology. The learning rates also take into account benefits from economy of scale and benefits related to using automated production processes at high production volumes.

The potential for improving technologies is linked to the level of technological maturity. The technologies are categorized within one of the following four levels of technological maturity.

Category 1. Technologies that are still in the *research and development phase*. The uncertainty related to price and performance today and in the future is highly significant (e.g. wave energy converters, solid oxide fuel cells).

Category 2. Technologies in the *pioneer phase*. The technology has been proven to work through demonstration facilities or semi-commercial plants. Due to the limited application, the price and performance is still attached with high uncertainty, since development and customization is still needed. The technology still has a significant development potential (e.g. gasification of biomass).

Category 3. *Commercial technologies with moderate deployment*. The price and performance of the technology today is well known. These technologies are deemed to have a certain development potential and therefore there is a considerable level of uncertainty related to future price and performance (e.g. offshore wind turbines)

Category 4. *Commercial technologies, with large deployment*. The price and performance of the technology today is well known and normally only incremental improvements would be expected. Therefore, the future price and performance may also be projected with a relatively high level of certainty. (e.g. coal power, gas turbine)

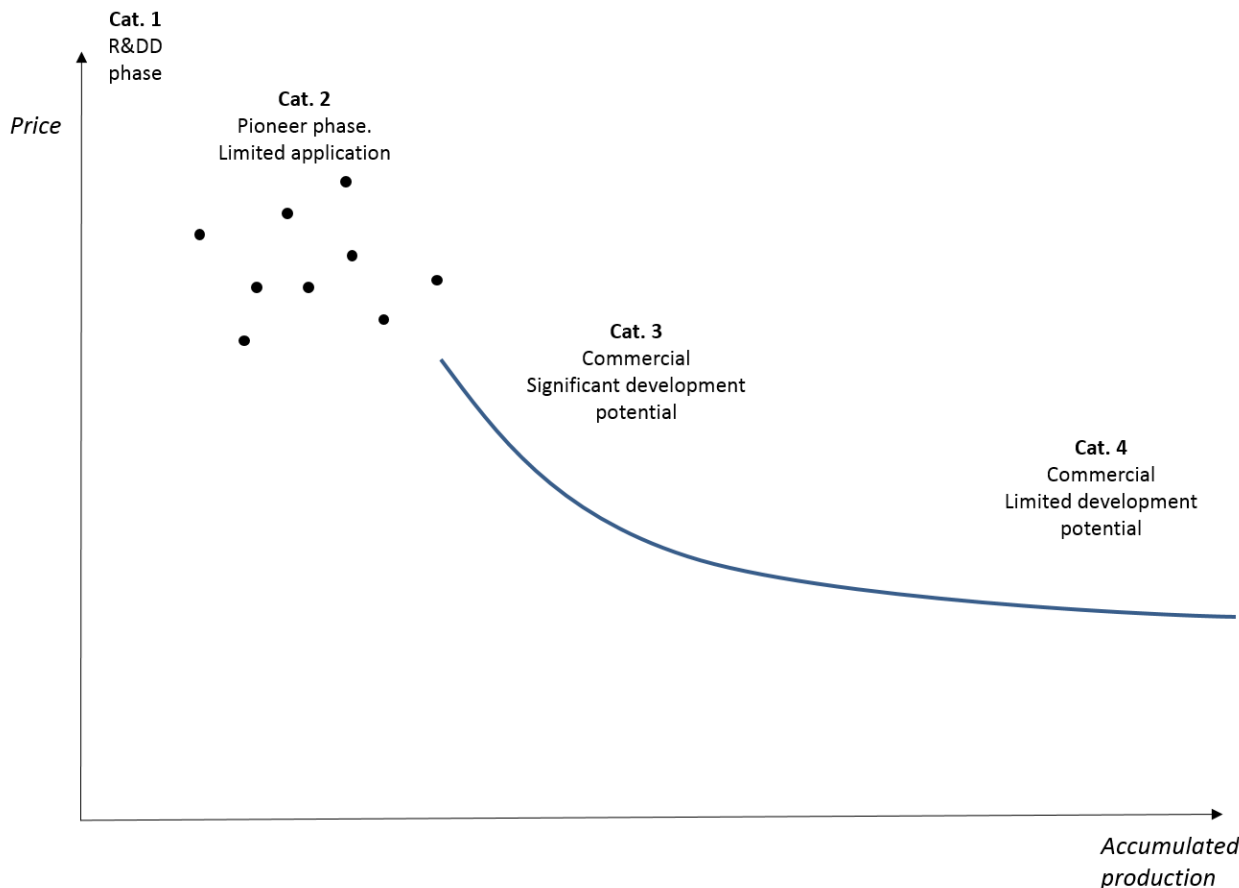

Figure 1: Technological development phases. Correlation between accumulated production volume (MW) and price.

**Uncertainty**

The catalogue covers both mature technologies and technologies under development. This implies that the price and performance of some technologies may be estimated with a relatively high level of certainty whereas in the case of others, both cost and performance today as well as in the future are associated with high levels of uncertainty.

This section of the technology chapters explains the main challenges to precision of the data and identifies the areas on which the uncertainty ranges in the quantitative description are based. This includes technological or market related issues of the specific technology as well as the level of experience and knowledge in the sector and possible limitations on raw materials. The issues should also relate to the technological development maturity as discussed above.

The level of uncertainty is illustrated by providing a lower and higher bound beside the central estimate, which shall be interpreted as representing probabilities corresponding to a 90% confidence interval. It should be noted, that projecting costs of technologies far into the future is a task associated with very large uncertainties. Thus, depending on the technological maturity expressed and the period considered, the confidence interval may be very large. It is the case, for example, of less developed technologies (category 1 and 2) and long time horizons (2050).

**Additional remarks**

This section includes other information, for example links to web sites that describe the technology further or give key figures on it.

**References**

References are numbered in the text in squared brackets and bibliographical details are listed in this section.

### 1.3. Quantitative description

To enable comparative analyses between different technologies it is imperative that data are actually comparable: All cost data are stated in fixed 2015 prices excluding value added taxes (VAT) and other taxes. The information given in the tables relate to the development status of the technology at the point of final investment decision (FID) in the given year (2015, 2020, 2025, 2030 2040 and 2050 where applicable). FID is assumed to be taken when financing of a project is secured and all permits are at hand. The year of commissioning will depend on the construction time of the individual technologies.

A typical table of quantitative data is shown below, containing all parameters used to describe the specific technologies. The table consists of a generic part, which is identical for groups of similar technologies (thermal power plants, non-thermal power plants and heat generation technologies) and a technology specific part, containing information, which is only relevant for the specific technology. The generic part is made to allow for easy comparison of technologies.

Each cell in the table contains only one number, which is the central estimate for the market standard technology, i.e. no range indications.

Uncertainties related to the figures are stated in the columns named *uncertainty*. To keep the table simple, the level of uncertainty is only specified for years 2020 and 2050. For updates after 2020, 2025 is the first year of uncertainty.

The level of uncertainty is illustrated by providing a lower and higher bound. These are chosen to reflect the uncertainties of the best projections by the authors. The section on uncertainty in the qualitative description for each technology indicates the main issues influencing the uncertainty related to the specific technology. For technologies in the early stages of technological development or technologies especially prone to variations of cost and performance data, the bounds expressing the confidence interval could result in large intervals. The uncertainty only applies to the market standard technology; in other words, the uncertainty interval does not represent the product range (for example a product with lower efficiency at a lower price or vice versa).

The level of uncertainty is stated for the most critical figures such as investment cost and efficiencies. Other figures are considered if relevant.

All data in the tables are referenced by a number in the utmost right column (Ref), referring to source specifics below the table. The following separators are used:

- ; (semicolon)                    separation between the time horizons
- / (forward slash)                separation between sources with different data
- + (plus)                            agreement between sources on same data

Notes include additional information on how the data are obtained, as well as assumptions and potential calculations behind the figures presented. Before using the data, please be aware that essential information may be found in the notes below the table.

The generic parts of the tables for thermal power plants, non-thermal power plants and heat generation technologies are presented below:



| Technology  | Thermal elec. generation CHP or ELEC only |      |      |      |                    |       |                    |       |      |     |
|---|---|------|------|------|--------------------|-------|--------------------|-------|------|-----|
|   | 2015                                      | 2020 | 2030 | 2050 | Uncertainty (2020) |       | Uncertainty (2050) |       | Note | Ref |
| Energy/technical data   |   |      |      |      | Lower              | Upper | Lower              | Upper |      |     |
| Generating capacity for one unit (MW)   |   |      |      |      |                    |       |                    |       |      |     |
| Electricity efficiency (condensation mode for extraction plants), net (%), name plate     |   |      |      |      |                    |       |                    |       |      |     |
| Electricity efficiency (condensation mode for extraction plants), net (%), annual average |   |      |      |      |                    |       |                    |       |      |     |
| Cb coefficient (50°C/100°C)   |   |      |      |      |                    |       |                    |       |      |     |
| Cv coefficient (50°C/100°C)   |   |      |      |      |                    |       |                    |       |      |     |
| Forced outage (%)   |   |      |      |      |                    |       |                    |       |      |     |
| Planned outage (weeks per year)   |   |      |      |      |                    |       |                    |       |      |     |
| Technical lifetime (years)  |   |      |      |      |                    |       |                    |       |      |     |
| Construction time (years)   |   |      |      |      |                    |       |                    |       |      |     |
| <b>Regulation ability</b>   |   |      |      |      |                    |       |                    |       |      |     |
| Primary regulation (% per 30 seconds)   |   |      |      |      |                    |       |                    |       |      |     |
| Secondary regulation (% per minute)   |   |      |      |      |                    |       |                    |       |      |     |
| Minimum load (% of full load)   |   |      |      |      |                    |       |                    |       |      |     |
| Warm start-up time (hours)  |   |      |      |      |                    |       |                    |       |      |     |
| Cold start-up time (hours)  |   |      |      |      |                    |       |                    |       |      |     |
| <b>Environment</b>  |   |      |      |      |                    |       |                    |       |      |     |
| SO <sub>2</sub> (degree of desulphuring, %)   |   |      |      |      |                    |       |                    |       |      |     |
| NO <sub>x</sub> (g per GJ fuel)   |   |      |      |      |                    |       |                    |       |      |     |
| CH <sub>4</sub> (g per GJ fuel)   |   |      |      |      |                    |       |                    |       |      |     |
| N <sub>2</sub> O (g per GJ fuel)  |   |      |      |      |                    |       |                    |       |      |     |
| <b>Financial data</b>   |   |      |      |      |                    |       |                    |       |      |     |
| Specific investment (M€/MW)   |   |      |      |      |                    |       |                    |       |      |     |
| - of which equipment  |   |      |      |      |                    |       |                    |       |      |     |
| - of which installation   |   |      |      |      |                    |       |                    |       |      |     |
| Fixed O&M (€/MW/year)   |   |      |      |      |                    |       |                    |       |      |     |
| Variable O&M (€/MWh)  |   |      |      |      |                    |       |                    |       |      |     |
| Startup cost (€/MW/startup)   |   |      |      |      |                    |       |                    |       |      |     |

## Introduction

| Technology                            | Non-thermal electricity generation |      |      |      |                    |       |                    |       |      |     |
|---------------------------------------|------------------------------------|------|------|------|--------------------|-------|--------------------|-------|------|-----|
|                                       | 2015                               | 2020 | 2030 | 2050 | Uncertainty (2020) |       | Uncertainty (2050) |       | Note | Ref |
| Energy/technical data                 |                                    |      |      |      | Lower              | Upper | Lower              | Upper |      |     |
| Generating capacity for one unit (MW) |                                    |      |      |      |                    |       |                    |       |      |     |
| Average annual full-load hours        |                                    |      |      |      |                    |       |                    |       |      |     |
| Forced outage (%)                     |                                    |      |      |      |                    |       |                    |       |      |     |
| Planned outage (weeks per year)       |                                    |      |      |      |                    |       |                    |       |      |     |
| Technical lifetime (years)            |                                    |      |      |      |                    |       |                    |       |      |     |
| Regulation ability                    |                                    |      |      |      |                    |       |                    |       |      |     |
| Primary regulation (% per 30 seconds) |                                    |      |      |      |                    |       |                    |       |      |     |
| Secondary regulation (% per minute)   |                                    |      |      |      |                    |       |                    |       |      |     |
| Financial data                        |                                    |      |      |      |                    |       |                    |       |      |     |
| Specific investment (M€/MW)           |                                    |      |      |      |                    |       |                    |       |      |     |
| - of which equipment                  |                                    |      |      |      |                    |       |                    |       |      |     |
| - of which installation               |                                    |      |      |      |                    |       |                    |       |      |     |
| Fixed O&M (€/MW/year)                 |                                    |      |      |      |                    |       |                    |       |      |     |
| Variable O&M (€/MWh)                  |                                    |      |      |      |                    |       |                    |       |      |     |

**Introduction**

| Technology  | Heat only generation tech (boilers, heat pumps, geothermal) |      |      |      |                    |       |                    |       |      |     |
|---|---|------|------|------|--------------------|-------|--------------------|-------|------|-----|
|   | 2015  | 2020 | 2030 | 2050 | Uncertainty (2020) |       | Uncertainty (2050) |       | Note | Ref |
| Energy/technical data                             |   |      |      |      | Lower              | Upper | Lower              | Upper |      |     |
| Heat generation capacity for one unit (MW)        |   |      |      |      |                    |       |                    |       |      |     |
| Total efficiency, net (%), name plate             |   |      |      |      |                    |       |                    |       |      |     |
| Total efficiency , net (%), annual average        |   |      |      |      |                    |       |                    |       |      |     |
| Auxiliary electricity consumption (% of heat gen) |   |      |      |      |                    |       |                    |       |      |     |
| Forced outage (%)                                 |   |      |      |      |                    |       |                    |       |      |     |
| Planned outage (weeks per year)                   |   |      |      |      |                    |       |                    |       |      |     |
| Technical lifetime (years)                        |   |      |      |      |                    |       |                    |       |      |     |
| Construction time (years)                         |   |      |      |      |                    |       |                    |       |      |     |
| <b>Regulation ability</b>                         |   |      |      |      |                    |       |                    |       |      |     |
| Primary regulation (% per 30 seconds)             |   |      |      |      |                    |       |                    |       |      |     |
| Secondary regulation (% per minute)               |   |      |      |      |                    |       |                    |       |      |     |
| Minimum load (% of full load)                     |   |      |      |      |                    |       |                    |       |      |     |
| Warm start-up time (hours)                        |   |      |      |      |                    |       |                    |       |      |     |
| Cold start-up time (hours)                        |   |      |      |      |                    |       |                    |       |      |     |
| <b>Environment</b>                                |   |      |      |      |                    |       |                    |       |      |     |
| SO <sub>2</sub> (g per GJ fuel)                   |   |      |      |      |                    |       |                    |       |      |     |
| NO <sub>x</sub> (g per GJ fuel)                   |   |      |      |      |                    |       |                    |       |      |     |
| CH <sub>4</sub> (g per GJ fuel)                   |   |      |      |      |                    |       |                    |       |      |     |
| N <sub>2</sub> O (g per GJ fuel)                  |   |      |      |      |                    |       |                    |       |      |     |
| <b>Financial data</b>                             |   |      |      |      |                    |       |                    |       |      |     |
| Specific investment (M€ per MW)                   |   |      |      |      |                    |       |                    |       |      |     |
| - of which equipment                              |   |      |      |      |                    |       |                    |       |      |     |
| - of which installation                           |   |      |      |      |                    |       |                    |       |      |     |
| Fixed O&M (€/MW/year)                             |   |      |      |      |                    |       |                    |       |      |     |
| Variable O&M (€/MWh)                              |   |      |      |      |                    |       |                    |       |      |     |
| Startup cost (€/MW/startup)                       |   |      |      |      |                    |       |                    |       |      |     |

### Energy/technical data

#### Generating capacity for one unit

The capacity, preferably a typical capacity (not maximum capacity), is stated for a single unit, capable of producing energy e.g. a single wind turbine (not a wind farm), or a single gas turbine (not a power plant consisting of multiple gas turbines).

In the case of a modular technology such PV or solar heating, a typical size of a solar power plant based on the historical installations or the market standard is chosen as a unit. Different sizes may be specified in separated tables, e.g. Small PV, Medium PV, Large PV.

The capacity is given as net generation capacity in continuous operation, i.e. gross capacity (output from generator) minus own consumption (house load), equal to capacity delivered to the grid. For heat only technologies, any auxiliary electricity consumption for pumps etc. is not counted in the capacity. For combined heat and power generation, only the electric capacity is stated. For extraction plants, the capacity is stated in condensation mode.

The unit MW is used both for electric generation capacity and heat production capacity. While this is not in accordance with thermodynamic formalism, it makes comparisons easier and provides a more intuitive link between capacities, production and full load hours.

The relevant range of sizes of each type of technology is represented by a range of capacities stated in the notes for the "capacity" field in each technology table, for example 200-1000 MW for a new coal-fired power plant.

It should be stressed that data in the table is based on the typical capacity, for example 600 MW for a coal-fired power plant. When deviations from the typical capacity are made, economy of scale effects need to be considered inside the range of typical sizes (see the section about investment cost). The capacity range should be stated in the notes.

#### Energy efficiencies

Efficiencies for all thermal plants (both electric, heat and combined heat and power) are expressed in percent at lower calorific heat value (lower heating value) at ambient conditions in Denmark, considering an average air temperature of approximately 8 °C.

The electric efficiency of thermal power plants equals the total delivery of electricity to the grid divided by the fuel consumption. Two efficiencies are stated: the nameplate efficiency as stated by the supplier and the expected typical annual efficiency. Total efficiency of thermal power plants can be calculated as described in the formulas of the Annex in the previous catalogue for energy plants available from the Danish Energy Agency's web site.

For extraction plants, the electric efficiency is stated in condensation mode.

For heat only technologies, the total efficiency equals the heat delivered to the district heating grid divided by the fuel consumption. The auxiliary electricity consumption is not included in the efficiency, but stated separately in percentage of heat generation capacity (i.e. MW auxiliary/MW heat).

The energy supplied by the heat source for heat pumps (both electric and absorption) is not counted as input energy. The temperatures of the heat source are specified in the specific technology chapters.

The expected typical annual efficiency takes into account a typical number of start-ups and shut-downs and is based on the assumed full load hours stated in the introduction (table 1). Regarding the assumed number of start-ups for different technologies, an indication is given in the financial data description, under start-up costs.

Often, the electrical efficiency decreases slightly during the operating life of a thermal power plant. This degradation is not reflected in the stated data. As a rule of thumb 2.5 – 3.5 % may be subtracted during the lifetime (e.g. from 40 % to 37 %). Specific data are given in [3].

Some combined heat and power plants and heat producing boilers are equipped with flue gas condensation equipment, a process whereby the flue gas is cooled below its water dew point and the heat released by the resulting condensation of water is recovered as low temperature heat. In these cases, the stated efficiencies include the added efficiency of the flue gas condensation equipment.

If a combined heat and power plant is equipped with a turbine bypass enabling the plant to produce only heat – for example during periods with low electricity prices – this is mentioned in a note. Per default, it is assumed that the heat efficiency equals the plant's total efficiency when the turbine bypass is applied. Moreover, it is assumed that in by-pass mode the heat capacity corresponds to the sum of the heat and electrical capacities in back-pressure mode.

In a Danish context, seawater is normally used for cooling/condensation, when there is a surplus of heat generation from a CHP plant. Therefore, cooling towers are not considered, for the CHP plant in this catalogue.

The energy efficiency for intermittent technologies (e.g. PV and wind) is expressed as capacity factor. The capacity factor is calculated as the annual production divided by the maximum potential annual production. The maximum potential annual production is calculated assuming the plant has been operating at full load for the entire year, i.e. 8760 hours /year.

### Auxiliary electricity consumption

For heat-only technologies the consumption of electricity for auxiliary equipment such as pumps, ventilation systems, etc. is stated separately in percentage of heat generation capacity (i.e. MW auxiliary/MW heat).

For heat pumps, internal consumption is considered part of the efficiency (coefficient of performance, COP), while other electricity demand for external pumping, e.g. ground water pumping, is stated under auxiliary electricity consumption.

For CHP generation, auxiliary consumption is not stated separately but included in the net efficiency and for non-thermal plants, as a reduction in the number of full load hours.

### Cogeneration values

The  $C_b$ -coefficient (backpressure coefficient) is defined as the maximum power generation capacity in backpressure mode divided by the maximum heat production capacity (including flue gas condensation if applicable).

The  $C_v$ -value for an extraction steam turbine is defined as the loss of electricity production, when the heat production is increased one unit at constant fuel input.

Values for  $C_b$  and  $C_v$  are given – unless otherwise stated – at 100 °C forward temperature and 50 °C return temperature, corresponding to heat delivered to district heating transmission systems. For technologies where delivery to district heating distribution systems are more relevant a temperature set of 80/40 °C may also be used, and this is stated in the data sheet.

### Average annual full load hours

The average annual capacity factor mentioned above describes the average annual net generation divided by the theoretical maximum annual net generation if the plant were operating at full capacity for 8760 hours per year. The equivalent full load hours per year is determined by multiplying the capacity factor by 8760 hours, the total number of hours in a year.

The full load hours for non-thermal technologies represent the expected production considering planned and forced outage and auxiliary consumption, if any.

Full load hours vary largely depending on the location and the technology choice. The value stated refers to the Danish context, in an average location and with market standard technology.

### Forced and planned outage

Forced outage is defined as the number of weighted forced outage hours divided by the sum of forced outage hours and operation hours. The weighted forced outage hours are the sum of hours of reduced production caused by unplanned outages, weighted according to how much capacity was out.

Forced outage is given in percent, while planned outage (for example due to renovations) is given in days per year.

### Technical lifetime

The technical lifetime is the expected time for which an energy plant can be operated within, or acceptably close to, its original performance specifications, provided that normal operation and maintenance takes place. During this lifetime,

some performance parameters may degrade gradually but still stay within acceptable limits. For instance, power plant efficiencies often decrease slightly (few percent) over the years, and O&M costs increase due to wear and degradation of components and systems. At the end of the technical lifetime, the frequency of unforeseen operational problems and risk of breakdowns is expected to lead to unacceptably low availability and/or high O&M costs. At this time, the plant is decommissioned or undergoes a lifetime extension, which implies a major renovation of components and systems as required to make the plant suitable for a new period of continued operation.

The technical lifetime stated in this catalogue is a theoretical value inherent to each technology, based on experience. As stated earlier, the thermal technologies producing electricity and/or heat are in general assumed to be designed for operated for approximately 4,000-5,000 full loads hours annually. The expected technical lifetime takes into account a typical number of start-ups and shut-downs (an indication of the number of start-ups and shut-downs is given in the Financial data description, under Start-up costs).

In real life, specific plants of similar technology may operate for shorter or longer times. The strategy for operation and maintenance, e.g. the number of operation hours, start-ups, and the reinvestments made over the years, will largely influence the actual lifetime.

**Construction time**

Time from final investment decision (FID) until commissioning completed (start of commercial operation), expressed in years.

**Regulation ability**

Five parameters describe the electricity regulation capability of the technologies:

- A. Primary regulation (% per 30 seconds): frequency control
- B. Secondary regulation (% per minute): balancing power
- C. Minimum load (percent of full load).
- D. Warm start-up time, (hours)
- E. Cold start-up time, (hours)

For several technologies, these parameters are not relevant, e.g. if the technology is regulated instantly in on/off-mode.

Parameters A and B are spinning reserves; i.e. the ability to regulate when the technology is already in operation.

Parameter D. The warm start-up time used for boiler technologies is defined as the time it takes to reach operating temperatures and pressure and start production from a state where the water temperature in the evaporator is above 100°C, which means that the boiler is pressurized.

Parameter E. The cold start-up time used for boiler technologies is defined as the time it takes to reach operating temperature and pressure and start production from a state where the boiler is at ambient temperature and pressure.

**Environment**

All plants are assumed to be designed to comply with the regulation that is currently in place in Denmark and planned to be implemented within the 2020 time horizon.

The emissions below are stated in mass per GJ of fuel at the lower heating value.

**CO<sub>2</sub> emission** values are not stated, as these depend only on the fuel, not the technology.

**SO<sub>x</sub> emissions** are calculated based on the following sulfur contents of fuels:

|                | Coal | Ori-<br>mulsion | Fuel oil | Gas oil | Natural<br>gas | Peat | Straw | Wood-<br>fuel | Waste | Biogas |
|----------------|------|-----------------|----------|---------|----------------|------|-------|---------------|-------|--------|
| Sulphur, kg/GJ | 0.27 | 0.99            | 0.25     | 0.07    | 0.00           | 0.24 | 0.20  | 0.00          | 0.27  | 0.00   |

For technologies, where desulphurization equipment is employed (typically large power plants), the degree of desulphurization is stated in percent.

**NO<sub>x</sub>** . NO<sub>x</sub> equals NO<sub>2</sub> + NO, where NO is converted to NO<sub>2</sub> in weight-equivalents.

**Greenhouse gas emissions** include CH<sub>4</sub> and N<sub>2</sub>O in grams per GJ fuel.

**Particles** includes the fine particle matters (PM 2.5). The value is given in grams per GJ of fuel.

### Financial data

Financial data are all in Euro (€), fixed prices, at the 2015-level and exclude value added taxes (VAT) and other taxes. For updates after 2020, prices are given at the 2020-level. This is specified in the corresponding chapter.

Several data originate in Danish references. For those data a fixed exchange ratio of 7.45 DKK per € has been used.

The previous catalogue was in 2011 prices. Some data have been updated by applying the general inflation rate in Denmark (2011 prices have been multiplied by 1.0585 to reach the 2015 price level).

European data, with a particular focus on Danish sources, have been emphasized in developing this catalogue. This is done as generalizations of costs of energy technologies has been found to be impossible above the regional or local levels, as per IEA reporting from 2015 [4]. For renewable energy technologies this effect is even stronger as the costs are widely determined by local conditions.

### Investment costs

The investment cost is also called the engineering, procurement and construction (EPC) price or the overnight cost. Infrastructure and connection costs, i.e. electricity, fuel and water connections inside the premises of a plant, are also included.

The investment cost is reported on a normalized basis, i.e. cost per MW. The specific investment cost is the total investment cost divided by the capacity stated in the table, i.e. the capacity as seen from the grid, whether electricity or district heat. For electricity generating technologies, incl. combined heat and power generation, the denominator is the electric capacity.

The investment cost of extraction steam turbines, which can be operated in condensation mode, is stated as cost per MW-condensation mode capacity.

Where possible, the investment cost is divided on equipment cost and installation cost. Equipment cost covers the components and machinery including environmental facilities, whereas installation cost covers engineering, civil works, buildings, grid connection, installation and commissioning of equipment.

The rent of land is not included but may be assessed based on the space requirements, if specified in the qualitative description.

The owners' predevelopment costs (administration, consultancy, project management, site preparation, approvals by authorities) and interest during construction are not included. The costs to dismantle decommissioned plants are also not included. Decommissioning costs may be offset by the residual value of the assets.

#### *Cost of grid expansion*

The costs of grid expansion from adding a new electricity generator or a new large consumer (e.g. an electric boiler or heat pump) to the grid are not included in the presented data.

The most important costs are related to strengthening or expansion of the local grid and/or substations (voltage transformation, pumping or compression/expansion). The costs vary significantly depending on the type and size of generator and local conditions. For planning purposes, a generic cost of 0.14 M€2015 may be added to the stated investment costs per MW the grid needs be strengthened. This is due for a single expansion. If more generators (or consumers) are connected at the same time, the aggregated capacity addition may be smaller than the sum of the individual expansions, since peak-loads do not occur simultaneously.

#### *Business cycles*

The cost of energy equipment shows fluctuations that can be related to business cycles. This was the case of the period 2007-2008 for example, where costs of many energy generation technologies surged dramatically. The trend was general and global. An example is combined cycle gas turbines (CCGT), for which prices increased sharply from \$400-600 per kW to peaks of \$1250. When projecting the costs of technologies, it is attempted to compensate, as far as possible, for the effect of any business cycles that may influence the current prices.

### *Economy of scale*

The main idea of the catalogue is to provide technical and economic figures for particular sizes of plants. Where plant sizes vary in a large range, different sizes are defined and separate technology chapters are developed.

For assessment of data for plant sizes not included in the catalogue, some general rules should be applied with caution to the scaling of plants.

The cost of one unit for larger power plants is usually less than that for smaller plants. This is called the 'economy of scale'. The basic equation [2] is:

$$\frac{C_1}{C_2} = \left( \frac{P_1}{P_2} \right)^a$$

Where:  $C_1$  = Investment cost of plant 1 (e.g. in million EUR)

$C_2$  = Investment cost of plant 2

$P_1$  = Power generation capacity of plant 1 (e.g. in MW)

$P_2$  = Power generation capacity of plant 2

$a$  = Proportionality factor

Usually, the proportionality factor is about 0.6 – 0.7, but extended project schedules may cause the factor to increase. It is important, however, that the plants are essentially identical in construction technique, design, and construction time frame and that the only significant difference is in size.

The relevant ranges where the economy of scale correction applies are stated in the notes for the capacity field of each technology table. The stated range represents typical capacity ranges.

Large-scale plants, such as coal and nuclear power plants, seems to have reached a size limit, as few investors are willing to add increments of 1000 MW or above. Instead of the scaling effect, multiple unit configurations may provide savings by allowing sharing of balance of plant equipment and support infrastructure. Typically, about 15 % savings in investment cost per MW can be achieved for combined cycle gas turbines and big steam power plants from a twin unit arrangement versus a single unit [3].

### **Operation and maintenance (O&M) costs**

The fixed share of O&M is calculated as cost per generating capacity per year (€/MW/year), where the generating capacity is the one defined at the beginning of this chapter and stated in the tables. It includes all costs, which are independent of how many hours the plant is operated, e.g. administration, operational staff, payments for O&M service agreements, network or system charges, property tax, and insurance. Any necessary reinvestments to keep the plant operating within the technical lifetime are also included, whereas reinvestments to extend the life are excluded. Reinvestments are discounted at 4 % annual discount rate in real terms. The cost of reinvestments to extend the lifetime of the plants may be mentioned in a note if data are available.

The variable O&M costs (€/MWh) include consumption of auxiliary materials (water, lubricants, fuel additives), treatment and disposal of residuals, spare parts and output related repair and maintenance (however not costs covered by guarantees and insurances).

Planned and unplanned maintenance costs may fall under fixed costs (e.g. scheduled yearly maintenance works) or variable costs (e.g. works depending on actual operating time), and are split accordingly.

Fuel costs are not included.



Auxiliary electricity consumption is included for heat only technologies. The electricity price applied is specified in the notes for each technology, together with the share of O&M costs due to auxiliary consumption. This enables corrections from the users with own electricity price figures. The electricity price does not include taxes and PSO.

It should be noticed that O&M costs often develop over time. The stated O&M costs are therefore average costs during the entire lifetime.

**Start-up costs**

The O&M costs stated in this catalogue includes start-up costs and takes into account a typical number of start-ups and shut-downs. Therefore, the start-up costs should not be specifically included in more general analyses. They should only be used in detailed dynamic analyses of the hour-by-hour load of the technology.

Start-up costs, are stated in costs per MW of generating capacity per start up (€/MW/startup), if relevant. They reflect the direct and indirect costs during a start-up and the subsequent shut down.

The direct start-up costs include fuel consumption, e.g. fuel which is required for heating up boilers and which does not yield usable energy, electricity consumption, and variable O&M costs corresponding to full load during the start-up period.

The indirect costs include the theoretical value loss corresponding to the lifetime reduction for one start up. For instance, during the heating-up, thermal and pressure variations will cause fatigue damage to components, and corrosion may increase in some areas due to e.g. condensation.

An assumption regarding the typical amount of start-ups is made for each technology in order to calculate the O&M costs. This assumption is specified in the notes. The following table shows the assumed number of start-ups per year included in the O&M costs for some technologies.

|  | Assumed number of start-ups per year |
|--|--------------------------------------|
| Coal CHP                                   | 15                                   |
| Natural gas CHP (except gas engines)       | 30                                   |
| Gas Engines                                | 100                                  |
| Wood pellet CHP                            | 15                                   |
| Heat only boilers                          | 50                                   |
| Municipal solid-waste / biogas stand alone | 5                                    |
| Geothermal heat                            | 5                                    |
| Heat pumps                                 | 30                                   |
| Electric boilers                           | 100                                  |

The stated O&M costs may be corrected to represent a different number of start-ups than the one presented in the table by using the stated start-up costs with the following formula:

$$O\&M_{new} = O\&M_{old} - (Startup\ cost * n_{startup}^{old}) + (Startup\ cost * n_{startup}^{new})$$

where  $n_{startup}^{old}$  is the number of start-ups specified in the notes for the specific technology and  $n_{startup}^{new}$  is the desired number of start-ups.

**Technology specific data**

Additional data is specified in this section, depending on the technology.

**Definitions**

The steam process in a CHP (co-generation of heat and power) plant can be of different types:

1. **Condensation:** All steam flows all the way through the steam turbine and is fed into a condenser, which is cooled by water at ambient temperature. A condensing steam turbine produces only electricity, no heat.

2. **Back-pressure:** All steam flows all the way through the steam turbine and is fed into a condenser, which is cooled by the return stream from a district heating network or an industrial process heating network. The condensation takes place at elevated temperatures enabling utilization of the produced heat. A back-pressure turbine produces electricity and heat, at an almost constant ratio.
3. **Extraction:** Works in the same way as condensation, but steam can be extracted from the turbine to produce heat (equivalent to back-pressure). This enables flexible operation where the electricity to heat ratio may be varied.

## References

Numerous reference documents are mentioned in each of the technology chapters. The references mentioned below are for Chapter 1 only.

- [1] Forudsætninger for samfundsøkonomiske analyser på energiområdet (Generic data to be used for socio-economic analyses in the energy sector), Danish Energy Agency, May 2009.
- [2] Economy of Scale in Power Plants, August 1977 issue of Power Engineering Magazine.
- [3] Projected Costs of Generating Electricity, International Energy Agency, 2010.
- [4] Projected Costs of Generating Electricity, International Energy Agency, 2015.
- [5] Konvergensprogram Danmark 2015, Social- og Indenrigsministeriet, March 2015.
- [6] Energy Technology Perspectives, International Energy Agency, 2012.
- [7] International Energy Agency. Available at: <http://www.iea.org/>. Accessed: 11/03/2016.

## 01 Supercritical Pulverized Fuel Power Plant

This chapter has been moved here from the previous Technology Data Catalogue for Electricity and district heating production from May 2012. Therefore, the text and data sheets do not follow the same guidelines as the remainder of the catalogue.

### Contact information:

Danish Energy Agency: Rikke Næraa, [rin@ens.dk](mailto:rin@ens.dk)

Author: Ea Energy Analyses

### Publication date

May 2012

### Amendments after publication date

| Date                 | Ref.   | Description   |
|----------------------|--|---|
| <b>October 2018</b>  | 01 Supercritical Pulverized Fuel Power Plant | Section for prediction of performance and costs added                       |
| <b>November 2017</b> | 01 Supercritical Pulverized Fuel Power Plant | Datasheet for Supercritical Pulverized Fuel Power Plant - Coal CHP included |

### Brief technology description

Large base-load units with pulverised fuel (PF) combustion and advanced (supercritical) steam data.

Supercritical steam data are above 240-260 bar and 560-570 °C. The term ‘ultra-supercritical’ has been used (e.g. by ref. 4) for plants with steam temperatures of approximately 580 °C and above. Advanced data (AD) goes up to 350 bar and 700 °C (ref. 3). The advanced steam cycle includes up to ten pre- heaters and double re-heating.

The AD plants obtain higher efficiencies, both the electricity efficiency in condensing mode and the total energy efficiency in backpressure mode. The higher efficiencies are obtained in full load mode as well as part load and the high efficiencies remain even after many years of operation.

The integrated coal gasification combined-cycle (IGCC) plants are a fundamentally different coal technology, expected to achieve efficiencies above 50% in demonstration projects before year 2020 (ref. 4). Data for this technology are not presented below, since the AD technology appears to have better performance data.

### Input

The process is primarily based on coal, but will be applicable to other fuels such as wood pellets and natural gas.

### Output

Power and possibly heat.

The auxiliary power need for a 500 MW plant is 40-45 MW, and the net electricity efficiency is thus 3.7-4.3 percentage points lower than the gross efficiency (ref. 3).

### Typical capacities

AD plants are built in capacities from 400 MW to 1000 MW.

### Regulation ability

Pulverized fuel power plants are able to deliver both primary load support (frequency control) and secondary load support.

The units are in general able to deliver 5% of their rated capacity as primary load support within 30 seconds at loads between 50% and 90%. This fast load control is achieved by utilizing certain water/steam buffers within the unit. The secondary load control takes over after approximately 5 minutes, when the primary load control has utilized its water/steam buffers. The secondary load control is able to sustain the 5% load rise achieved by the primary load control and even further to increase the load (if not already at maximum load) by running up the boiler load.

Negative load changes can also be achieved by by-passing steam (past the turbine) or by closure of the turbine steam valves and subsequent reduction of boiler load.

A secondary regulation ability of 4% per minute is achievable between approximately 50% and 90% load on a pulverized fuel fired unit. The unit will respond slower below 50% and above 90%, approximately at 2% per minute (ref. 5).

### Advantages/disadvantages

The efficiencies are not reduced as significantly at part load compared to full load as with CC-plants.

Coal fired power plants using the advanced steam cycle possess the same fuel flexibility as the conventional boiler technology. However, AD plants have higher requirements concerning fuel quality. Inexpensive heavy fuel oil cannot be burned due to materials like vanadium, unless the steam temperature (and hence efficiency) is reduced, and biomass fuels may cause corrosion and scaling, if not handled properly.

### Environment

The main ecological footprints from coal-fired AD plants are bulk waste (disposal of earth, cinder, and rejects from mining), climate change and acidification. The fly ash can be utilized 100% in cement and concrete.

### Research and development

Conventional super critical coal technology is fairly well established and so there appear to be no major breakthroughs ahead. There is very limited scope to improve the cycle thermodynamically. It is more likely that the application of new materials will allow higher efficiencies, though this is unlikely to come at a significantly lower cost (ref. 6).

Best-available-technology plants today operate at up to 600 °C. An electricity efficiency of 55 % requires steam at 700 °C and the use of nickel-based alloys (ref. 2). Further RD&D in such alloy steels is required in order to obtain increased strength, lower costs and thereby cheaper and more flexible plants.

### Examples of best available technology

- Avedøre Power Station (Copenhagen), Unit 2; 570 MW; gas fired; steam at turbine inlet 580 °C and 300 bar; pre-coupled gas turbines.
- Nordjylland Power Station, Unit 3; 400 MW, commissioned 1998, coal fired.
- Skærbæk Power Station, Unit 3; 400 MW, gas fired; commissioned 1997.

### Prediction of performance and costs

In Denmark, most thermal units are combined heat and power plants (CHP). Most other countries do not have the demand for residential heating to utilize the waste heat from power plants, and are therefore using pure condensing plants. It is assumed that all new coal fired CHP units in Denmark will be extraction units.

The following section follows the steps of (1) analysing the possible differences between CHP and condensing units which could impact the CAPEX and OPEX, then (2) analysing and comparing data of coal fired power plants from different sources. In this connection, OPEX is considered a total of fixed and variable O&M costs. Thereafter (3) an estimation of the split between fixed and variable O&M cost is performed.

The data is based upon the following publications and projects:

1. The IEA World Energy Outlook 2014 coal fired Ultra-supercritical power plants in Europe. Values used are the projection for 2020.
2. The IEA Projected Cost of Generating Electricity 2015 for coal fired power plants. Here both the 'world median' is used, and data from recently commissioned plants in the Netherlands. The three units in the Netherlands are chosen because of the proximity to Denmark, because the socio-economic parameters (labour cost etc) are assumed to be similar and because the units are new (all from 2015).

3. EIA Updated Capital Cost Estimates for Utility Scale Electricity Generating Plants 2013 for pulverizes coal fired advanced single units.<sup>1</sup>
4. Aggregated data from different projects on existing units that Ea Energy Analyses have been working on since 2010. Data is used for estimating O&M costs.

All prices in this analysis are in €2015. The cost from each source have been converted to its original value and currency, and then converted to €2015. All specific values are in MW electricity output. Due to economy-of-scale relationships, only larger power plants are considered, i.e. above 400 MW.

|        | Exchange rate to €2015 | Used by source |
|--------|------------------------|----------------|
| €2011  | 1.059                  | DEA TC 2011    |
| \$2012 | 0.824                  | [1]            |
| \$2013 | 0.767                  | [2],[3]        |

Table 1: Exchange rates from currency used in source to €2015.

In the evaluation, European plants are weighted higher than overseas (USA) plants, and newer plants (2015-2020) are weighted higher than older (before 2015). And data from newer sources are weighted higher than older.

#### Differences between CHP and condensing units

The main difference between a condensing power plant and an extraction CHP plant, is that an extraction plant needs an additional heat exchanger compared to a condensing plant (see Figure 1). This additional district heating heat exchanger utilizes extracted intermedia steam from the turbines. From Danish experiences, the whole district heating installation is only around 5% of the total CAPEX, which suggest only a small increase in the overall cost. There is therefore assumed 5 % higher costs of both CAPEX and OPEX on CHP compared to condensing power plants.

---

<sup>1</sup> In the report the costs estimates were based on information derived from actual or planned projects known to the consultant, when possible. When this information was not available, the project costs were estimated using costing models that account for the current labor and materials rates necessary to complete the construction of a generic facility as well as consistent assumptions for the contractual relationship between the project owner and the construction contractor. All costs were weighted average of the sources.

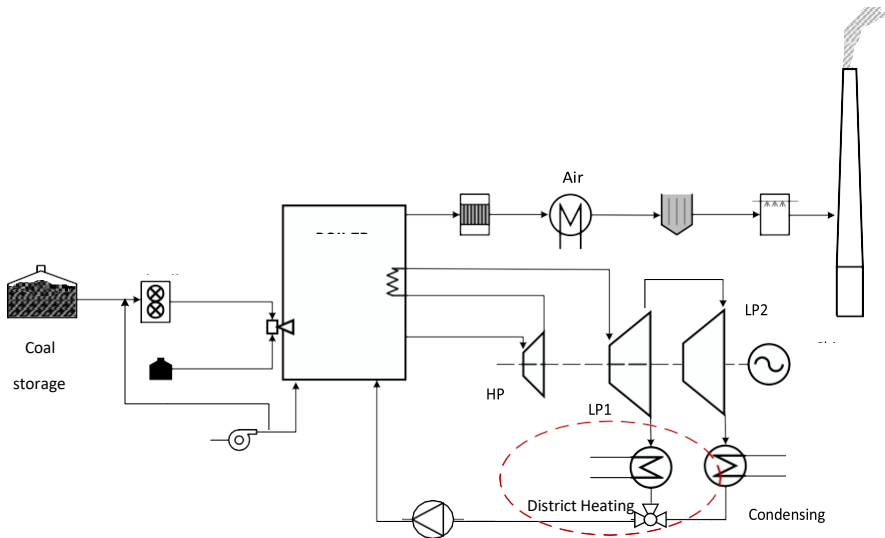

Figure 1: A schematic diagram of an extraction plant.

### CAPEX and OPEX cost of new coal fired power plants

All values compared are for new units (year 2020 is chosen when possible – assumed year of commissioning). The specific investment costs for the different sources are plotted in Figure 2 below. The MW is the unit’s full load condensing power capacity. For condensing units, it is assumed that the costs are for a power plant cooling with sea water, which is known to be the case for the three units in the Netherlands.

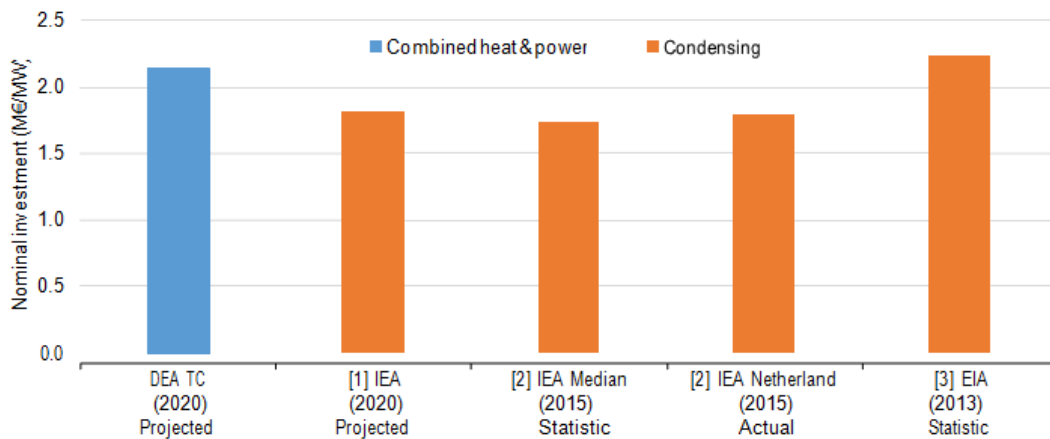

Figure 2: Nominal investment in coal fired power plants (2015M€/MW). The years in () indicate the year of the commission or statistic.

The investment cost from the European sources [1-2] is around 1.8 M€/MW, where the exception is the current value from the Technology Catalogue of 2.15 M€/MW, which is app. 20% higher. The cost listed by EIA for the USA is on the same level as the Technology Catalogue. According to the IEA the price of coal power is around 5 % higher in the USA compared to Europe. Under this assumption the EIA price for the USA can be translated to around 2 M€/MW for a European plant.

Weighting the newest projects and European sources highest, 1.8 M€/MW is proposed as the central estimate for condensing power plants. Assuming a 5% additional investment cost for adding the district heating units, the 1.9 M€/MW for coal fired CHP plants is proposed.

In the data sheet in the Technology Catalogue the OPEX is split into variable and fixed O&M costs. However, it is not always clear when a cost is going from fixed to variable and vice versa, and therefore different sources list O&M cost differently. To be sure that we can directly compare the costs we therefore look at O&M as a yearly sum (see Figure 3). And here used the amount of full load hours that each source assuming<sup>2</sup>. All sources assume a lifetime of 40 years.

Most sources project a decrease in the O&M cost for future plants (not shown in the figure), except the data in the current (before June 2017) Technology Catalogue, which surprisingly project an increase over time. The increase in the electrical efficiency over time is further increasing the O&M per input to the boiler, because the costs are given per MW and MWh electricity.

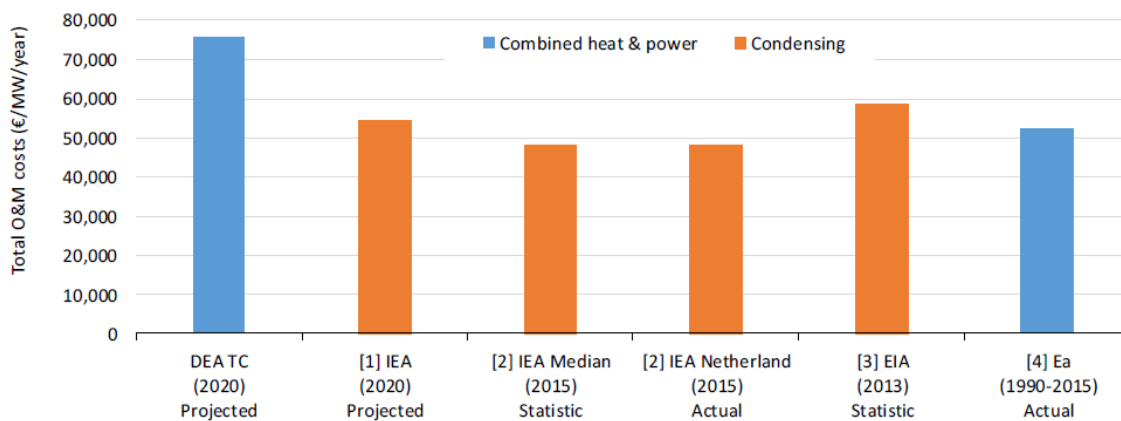

Figure 3: Total annual O&M costs for coal fired power plants (2015€/MW/year). The year in ( ) indicate the year of the projection or statistic.

The current data in the Technology Catalogue again list highest value, which is around 75,000 €/MW/year – i.e. 50% higher compared to the weighted average of the other sources of around 50,000 €/MW/year [1-4]. CHP plants are assumed to have a 5% higher O&M costs due to the extra heat element in the unit. So, the total O&M costs of a coal fired CHP unit are evaluated to be around 52,500 €/MW/year.

**Split between variable and fixed O&M cost**

As mentioned, it is not always clear when a cost is going from fixed to variable and vice versa. To evaluate the split, variable costs from the sources that list these are used (see Figure 4). The prices seem to be between 2-4 €/MWh.

<sup>2</sup> For the current DEA TC and the data from Ea are assumed 4500 hours and for the IEA and EIA sources are assumed 7500 hours.



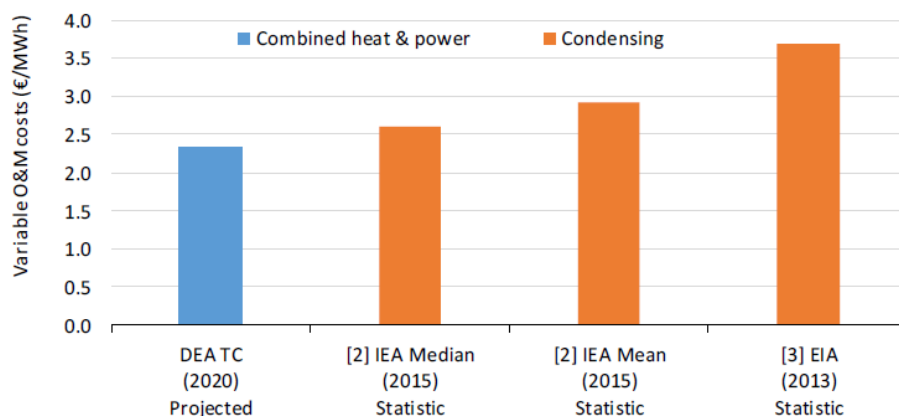

Figure 4: Variable O&M cost (2015€/MWh). The year in ( ) indicate the year of the projection or statistic.

Choosing 2.75 €/MWh as variable O&M cost for a condensing plant (weighting the newer sources highest) and adding 5% for the CHP part gives around 2.9 €/MWh. Using 7500 full load hours as used above, and 52,500 €/MW/year in total O&M costs, this yields a fixed O&M of 31,000 €/MW/year.

**Updated financial numbers**

The table below summarise the findings and updated financial figures of coal power CHP plants in the Danish Technology Catalogue for commission year 2020. Newer and European data are weighted higher than older data and data from overseas.

| Year 2020                         | Previous catalogue | New financial figures | Difference |
|-----------------------------------|--------------------|-----------------------|------------|
| <b>Nominal investment (M€/MW)</b> | 2.15               | 1.9                   | -12%       |
| <b>Fixed O&amp;M (€/MW/year)</b>  | 65,000             | 31,000                | -52%       |
| <b>Variable O&amp;M (€/MWh)</b>   | 2.3                | 2.9                   | +24%       |

Note: Data for plant with a max. capacity of 400-1000 MW. The costs are given in relation to the maximum electricity output, e.g. in condensing mode. The fixed and variable O&M are assumed to be independent of the amount of full load hours.

According to the NREL report<sup>3</sup> mature power plant costs are generally expected to follow the overall general inflation rate over the long term. And since the suggested prices listed in the table are in real 2015 prices, then no, or very little (annually 0% -1%), development is expected.

**Prediction of the cost in 2030 and 2050**

To predict the costs in 2030 and 2050, it is assumed that the cost is falling by 0.2 % p.a. This is based on an assumption of accumulation of capacity commissioned from 2020 to 2050 deduced from predictions of the

<sup>3</sup> Black & Veatch for NREL (2012), "Cost and performance data for power generation technologies"

future global installed electricity capacity in the 4D scenario in the Energy Technology Perspectives<sup>4</sup> [IEA,2016], and a assumed learning rate<sup>5</sup> of app. 8 % for coal technologies.

**Additional remarks**

The efficiencies shown in the tables below assume the availability of sufficient cooling water at low temperatures (North European oceans).

A steam extraction turbine enables a large degree of freedom in varying the electricity and heat generation. This is shown by the below (ideal) figure:

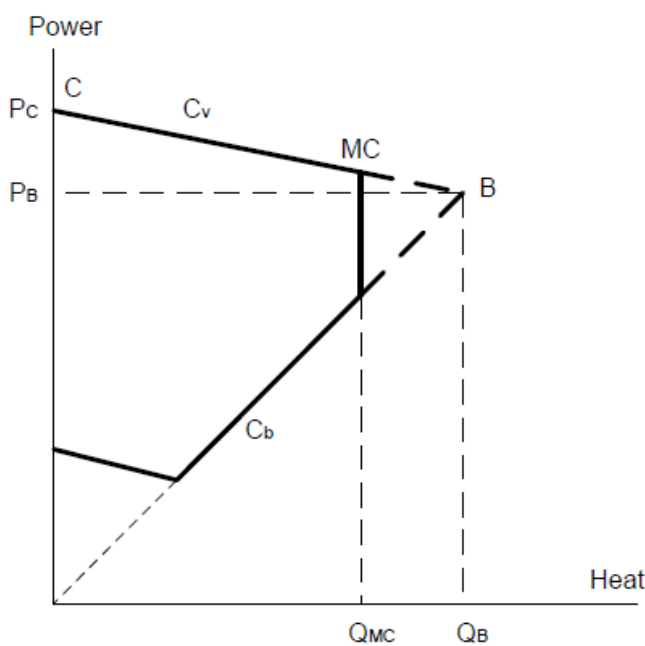

$P_C$ : Power capacity in full condensation mode; point C. No heat production.

$\eta_{e,c}$  : Electricity efficiency in full condensation mode.

$Q_B$ : Heat capacity in full back-pressure mode (no low-pressure condensation); point B.

$P_B$ : Power capacity in full back-pressure mode.

<sup>4</sup> IEA( 2016),Energy Technology Perspectives

<sup>5</sup> E.S. Rubin et al. / Energy Policy 86 (2015) page 198–218, A review of learning rates for electricity supply technologies

$Q_{MC}$ : Heat capacity at minimum low-pressure condensation; point MC.

$c_v$ : Loss of electricity generation per unit of heat generated at fixed fuel input; assumed constant.

$c_b$ : Back-pressure coefficient (electricity divided by heat); assumed constant.

$$H = \frac{P + c_v \cdot Q}{\eta_{e,c}}$$

The fuel consumption H for any given combination of power generation (P) and heat generation (Q):

At point MC the efficiencies can be determined by:

$\eta_{e,MC}$  : Electricity efficiency at minimum low-pressure condensation:

$$\eta_{e,MC} = \eta_{e,c} \cdot \left\{ 1 - \frac{c_v}{c_b + c_v} \cdot \frac{Q_{MC}}{Q_B} \right\}$$

$\eta_{q,MC}$  : Heat efficiency at minimum low-pressure condensation:

$$\eta_{q,MC} = \frac{\eta_{e,c}}{c_b + c_v} \cdot \frac{Q_{MC}}{Q_B}$$

$\eta_{tot,MC}$  : Total efficiency (electricity plus heat) at minimum low-pressure condensation:

$$\eta_{tot,MC} = \eta_{e,c} \cdot \left\{ 1 + \frac{1 - c_v}{c_b + c_v} \cdot \frac{Q_{MC}}{Q_B} \right\}$$

In 2009, 3 out of 13 Danish extraction steam turbines had  $Q_{MC}/Q_B = 1.0$ , the average of all units being 0.80. This excludes a number of extraction steam turbines, which to a large extent were operated as condensation turbines, since the district heating loads were very small.

More details are given in **Annex 1**.

The biggest capital items of a coal plant are boiler, steam turbine and generator, with the boiler alone accounting for over 25% of costs. The civil works component falls around 20%, while the fuel handling is larger item than for most other technologies, except solid fuel biomass. Flue gas desulphurisation (FGD), which once accounted for some 15-20% of investment cost has fallen over time such that FGD and SCR (selective catalytic reduction of NOx) together typically account for some 10-15% of investment (ref. 6).

## References

1. Elsam's and Elkraft's update of the Danish Energy Authority's technology catalogue (in Danish), 'Teknologidata for el- og varmeproduktionsanlæg', 1997.
2. Elforsk: "El från nya anläggningar", Stockholm, 2000.
3. [www.ad700.dk](http://www.ad700.dk)
4. "Energy technology perspectives 2008", International Energy Agency, 2008.
5. DONG Energy, 2009.
6. "UK Electricity Generation Costs Update", Mott MacDonald, June 2010; commissioned by the Department of Energy and Climate Change, United Kingdom.

## Datasheet

| Technology   | Pulverized coal fired, Supercritical steam process, extraction plant |        |        |        |      |                    |
|--|--|--------|--------|--------|------|--------------------|
|  | 2015   | 2020   | 2030   | 2050   | Note | Ref                |
| <b>Energy/technical data</b>                       |  |        |        |        |      |                    |
| Generating capacity for one unit (MW)              | 400 - 700  |        |        |        |      |                    |
| Electricity efficiency, condensation mode, net (%) | 44-48  | 46-51  | 52     | 52-55  | C    | 8;7;9;11           |
| C <sub>b</sub> coefficient (50°C/100°C)            | 0.75   | 0.84   | 1.01   |        | A    |                    |
| C <sub>v</sub> coefficient (50°C/100°C)            | 0.15   | 0.15   | 0.15   |        |      | 1                  |
| Availability (%)                                   | 95   | 95     | 95     |        | E    | 7                  |
| Technical lifetime (years)                         | 25   | 25     | 25     | 25     |      | 6                  |
| Construction time (years)                          | 4.5  | 4.5    | 4.5    |        |      | 2;3;3              |
| <b>Environment</b>                                 |  |        |        |        |      |                    |
| SO <sub>2</sub> (degree of desulphuring, %)        | 97   | 97     | 97     | 97     | B    | 5                  |
| NO <sub>x</sub> (g per GJ fuel)                    | 38   | 35     | 35     | 35     | B    | 12;5;5;5           |
| CH <sub>4</sub> (g per GJ fuel)                    | 1.5  | 1.5    | 1.5    | 1.5    |      | 13;5;5;5           |
| N <sub>2</sub> O (g per GJ fuel)                   | 0.8  | 0.8    | 0.8    | 0.8    |      | 13;5;5;5           |
| <b>Financial data (in 2015€)</b>                   |  |        |        |        |      |                    |
| Nominal investment (M€/MW)                         | 1.93   | 1.9    | 1.86   | 1.78   | J    | 17,18,19,20, 21,22 |
| Fixed O&M (€/MW/year)                              | 31,500   | 31,000 | 30,355 | 29,105 | J    | 17,18,19,20, 21,22 |
| Variable O&M (€/MWh)                               | 3.0  | 2.9    | 2.8    | 2.7    | J    | 17,18,19,20, 21,22 |
| <b>Regulation ability</b>                          |  |        |        |        |      |                    |
| Primary load support (% per 30 seconds)            | 5  | 5      | 5      | 5      | D    | 14                 |
| Secondary load support (% per minute)              | 4  | 4      | 4      | 4      | D    | 14                 |
| Minimum load (% of full load)                      | 18   | 15     | 15     | 10     |      | 10+14              |

**References:**

- 1 Elsam, November 2003
- 2 Elsam's and Elkraft's update of the Danish Energy Agency's 'Teknologidata for el- og varmeproduktionsanlæg', December 1997
- 3 Eltra, September 2003

- 5 Danish Energy Agency, 2009.
- 6 "Projected costs of generating electricity", International Energy Agency (IEA), 2005.
- 7 "Energy technology perspectives 2008", International Energy Agency, 2008.
- 8 Danish Energy Agency, 2008. Measured data (1994-2006) from newest power plants in Denmark.
- 9 Own estimate by Danish Energy Agency and Energinet.dk, 2011.
- 10 Energinet.dk, 2009
- 11 [www.ad700.dk](http://www.ad700.dk)
- 12 "En opdateret analyse af Danmarks muligheder for at reducere emissionerne af NOx" (Updated analysis of Denmark's options to reduce NOx emissions; in Danish), Danish Environmental Protection Agency, 2009.
- 13 National Environmental Research Institute, Denmark, 2009 (data from 2007).
- 14 DONG Energy, 2009.
- 15 "UK Electricity Generation Costs Update", Mott MacDonald, June 2010.
- 16 "The Costs of CO2 Capture, Transport and Storage", Zero Emissions Platform (ZEP), July 2011
- 17 The IEA World Energy Outlook 2014 coal fired Ultra-supercritical power plants in Europe. Values used are the projection for 2020.
- 18 The IEA Projected Cost of Generating Electricity 2015 for coal fired power plants. Here both the 'world median' is used, and data from recently commissioned plants in the Netherlands. The three units in the Netherlands are chosen because of the proximity to Denmark, because the socio-economic parameters (labour cost etc) are assumed to be similar and because the units are new (all from 2015).
- 19 EIA Updated Capital Cost Estimates for Utility Scale Electricity Generating Plants 2013 for pulverizes coal fired advanced single units.[1]
- 20 Aggregated data from different projects on existing units that Ea Energy Analyses have been working on since 2010. Data is used for estimating O&M costs.
- 21 IEA( 2016),Energy Technology Perspectives
- 22 E.S. Rubin et al. / Energy Policy 86 (2015) page 198–218, A review of learning rates for electricity supply technologies

**Notes:**

- A The C<sub>b</sub> values have been calculated from the electricity efficiencies in condensation mode, the C<sub>v</sub> values and a total efficiency (electricity plus heat) in full back-pressure mode of 90%. Cf. Annex 1.
- B The data for SO<sub>2</sub> and NO<sub>x</sub> emissions assume flue gas desulphurisation (wet gypsum) and DeNO<sub>x</sub> equipment of the "high dust" SCR type.
- C Supercritical in 2010 and ultra-supercritical from 2020.
- D Please refer to section 'Regulation ability' in the above qualitative description.
- E Outage rates are generally about 5% for plants that are 10-20 years old. Unless the plant is refurbished, the rate increases to 20% for plants that are 40 years old (ref. 7)

F It is assumed that the cost is falling by 0.2 % p.a.

|                    |       |
|--------------------|-------|
| Defaltor 2011-2015 | 1,059 |
|--------------------|-------|

## 02 Life Time Extensions of Coal Power Plants

### Contact information:

Danish Energy Agency: Rikke Næraa, [rin@ens.dk](mailto:rin@ens.dk)

Author: Ea Energy Analyses

### Publication date

August 2016

### Amendments after publication date

---

| Date | Ref. | Description |
|------|------|-------------|
|      |      |             |

---

## Qualitative description

### Brief technology description

Large coal power plants have been a major source of combined electricity and heat generation in Denmark for the last decades. When a plant has been in operation for 25 years or more, the reliability of its components and systems will likely decrease leading to reduced availability and/or increased O&M costs. Therefore, based on experience, it will usually be necessary and beneficial to carry out a larger package of work that addresses repairs, renovation, and replacement of selected components and systems depending on their actual condition. Often also, improvement of environmental performance may be required, e.g. by improving the flue gas cleaning performance. This 'Life Time Extension' (LTE) is done with the purpose of restoring the plant to come close to its original conditions in terms of availability, efficiency and O&M costs. The exact scope and extent of such a campaign though, shall be tailored to the actual plant in question and will depend on its design, previous records of operation, earlier major works carried out, etc. Also, the expected/desired future operation of the plant is taken into account. Whether or not to extend the life of a power plant is therefore not a simple decision, but involves complex economic and technical factors [1].

In this technology catalogue it is assumed that the life time extension

- takes place after approx. 25 years of normal operation, during which
- the maintenance of the plant has been carried out as planned, and
- enables the plant to be operated with the availability rate close to that of the original new plant
- within the originally expected O&M budget,
- for an extended life time of approx. 15-20 years

It may be convenient to carry out all necessary works in one campaign, to reduce the overall down time, or to distribute the work over several years. For this case it is assumed that all work is done in one campaign. It is expected that the original plant comply with the environmental legislation at the time of the LTE. The costs of bringing it up to date prior to the LTE are therefore not taken into account.

The LTE described here does not take specific measures to increase the efficiency, emissions level standards, or regulation abilities of the plant. Such required or desirable improvements may follow as a consequence without further investments, or may be possible at a reduced investment when major overhauls and component replacements are carried out anyhow.



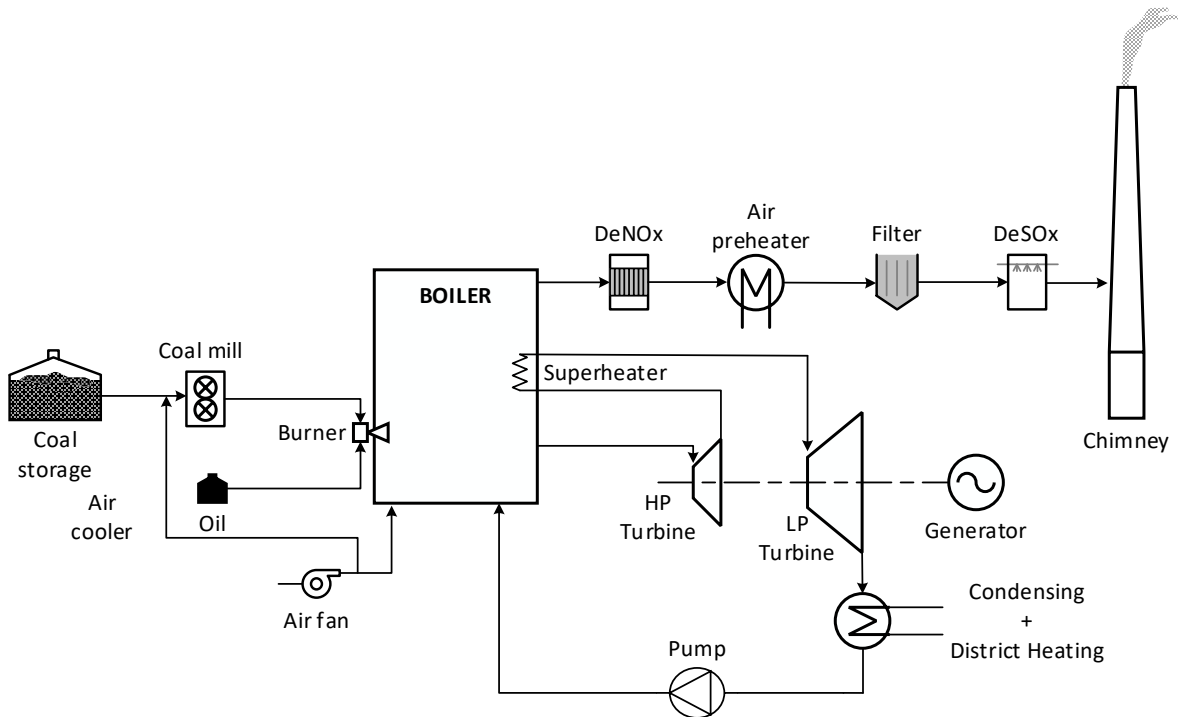

Figure 1: Sketch of the main elements of a large coal fired CHP plant.

In connection with the LTE the plant will be out of operation for a period, typically 6-9 months.

The LTE will typically involve considerable project costs for planning and management since it requires establishing a project organisation for engineering, purchase, construction management, test, and commissioning.

The distribution of works and costs involved with a LTE of an existing coal fired plant could typically be as follows, however depending widely on the actual scope [1]

Main elements can be:

- Revision of electrical systems
- Instrumentation and control systems replacement
- Pulverizers upgrade or replacement (fuel supply and disposal)
- Boiler upgrade,
- Turbine refurbishment (possibly generator refurbishment)
- Water systems (heat exchanges for condensers and district heating)
- Buildings
- Flue gas cleaning.

At top of that, there is a relatively large share of project- and unexpected costs (see figure 2). The basis for deciding which works to include in the LTE is an understanding of the plant's condition, which can be obtained using diagnostic systems and making a detailed remaining life assessment [2].

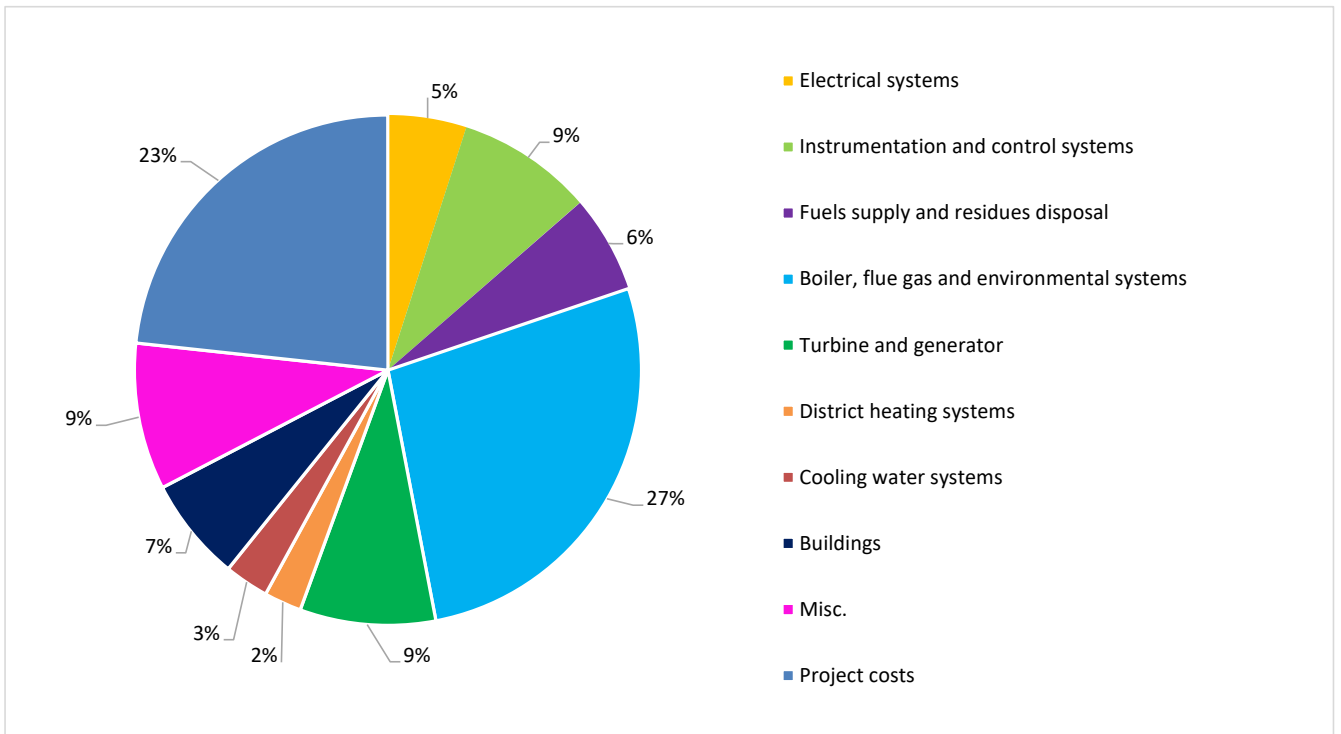

Figure 2: Diagram showing an example of the share of investment cost for an LTE project.

Life time extension of existing plants is also relevant when rebuilding to other fuels e.g. biomass as discussed in chapter 03 on conversion of power plants.

**Input**

Primary fuels are coal. Oil and/or natural gas are typically used for auxiliary start-up burners.

**Output**

The output is electricity and possibly heat for use in district heating systems.

**Typical capacities**

The capacity range considered is 200-400 MWe.

**Space requirement**

The space requirements are not considered to change due to LTE.

**Regulation ability and other power system services**

The regulation abilities of coal fired power plants, e.g. start-up time and ramp rates may improve in connection with LTE due to implementation of better control systems [2]. This effect is, however, not possible to quantify on a general level. In general, start-up times and -costs are not considered to change due to LTE.

**Advantages/disadvantages**

*Advantages*

Life time extension of existing large coal fired power plants offers a relatively quick and easy solution to keep existing capacity in operation, since the costs are typically several times lower than investments in new capacity. Typical Danish power plants of age 20-25 years have quite high efficiencies and environmental performance compared with today's standard, so the difference in comparison to a new plant may not be crucial. The overall difference in efficiency compared to a new plant will be 3-5% points.

### *Disadvantages*

One disadvantage is that the original performance data of the plant are difficult to alter significantly. Also, the future operation of coal fired plants is challenged by their environmental effects (especially CO<sub>2</sub> emissions), which may be deemed politically unacceptable on a medium to longer term.

### **Environment**

The lifetime extension is not in itself expected to change the environmental performance characteristics beyond the maximum allowed emission values at the time of LTE, that probably are more stringent than the original requirements. If advantageous or required, such further improvements may be implemented in connection with LTE campaign.

### **Research and development perspectives**

It is not anticipated that there will be a considerable further development in the technology relevant for life time extension of Danish large coal fired power plants. However, with the large number of coal power plants running worldwide, it is expected that LTE methods will generally improve.

### **Examples of market standard technology**

The life time extension (LTE) of DONG Energy's Studstrupværket blok 3, 350 MW, 2012-2013 is one of the most recent Danish examples [3]. There have only been few recent LTE projects in Denmark.

### **Uncertainty**

The investment costs of a LTE presented in the table are connected with relatively large uncertainties. The main reasons for this are the differences among the existing power plants in terms of design, technical condition, previous works carried out, etc. Also, some uncertainty is expected related to general variations of prices and markets in the energy sector, e.g. raw materials like steel and copper, and the supply situation in the construction sector.

### **Additional remarks**

NIL

### **Data sheets**

The following datasheet shows the technical, environmental and financial data for the specific technology. For more explanation, see the section about Quantitative description in the Introduction chapter. The columns "uncertainty" indicates the uncertainty or range of the parameter. The uncertainties only apply to the row, and cannot be read vertically, i.e. the lower uncertainty of the investment cost does not apply to the lower uncertainty of the capacity

| Technology  | Life time extension of coal power plant, extraction plant |      |      |      |                    |        |                    |       |      |            |
|---|---|------|------|------|--------------------|--------|--------------------|-------|------|------------|
|   | 2015  | 2020 | 2030 | 2050 | Uncertainty (2020) |        | Uncertainty (2050) |       | Note | Ref        |
| Energy/technical data   |   |      |      |      | Lower              | Upper  | Lower              | Upper |      |            |
| Generating capacity for one unit (MW)   | 300   | 300  | 300  |      | 200                | 400    | 200                | 400   |      |            |
| Electricity efficiency (condensation mode for extraction plants), net (%), name plate     | +0  | +0   | +0   |      | -1                 | +1     |                    |       | EF   | 7          |
| Electricity efficiency (condensation mode for extraction plants), net (%), annual average | +0  | +0   | +0   |      | -1                 | +1     |                    |       | EF   | 7          |
| Cb coefficient (50°C/100°C)   | +0  | +0   | +0   |      | +0                 | +0     |                    |       | AF   | 7          |
| Cv coefficient (50°C/100°C)   | +0  | +0   | +0   |      | +0                 | +0     |                    |       | AF   | 7          |
| Forced outage (%)   | +0  | +0   | +0   |      | +0                 | +0     |                    |       | AF   | 7          |
| Planned outage (weeks per year)   | +0  | +0   | +0   |      | +0                 | +0     |                    |       | AF   | 7          |
| Technical lifetime (years)  | 15  | 15   | 15   |      |                    |        |                    |       |      | 4, 5, 6, 7 |
| Construction time (years)   | 0.5   | 0.5  | 0.5  |      |                    |        |                    |       |      | 7          |
| Space requirement (1000m2/MW)   | +0  | +0   | +0   |      | +0                 | +0     |                    |       | AF   |            |
| <b>Regulation ability</b>   |   |      |      |      |                    |        |                    |       |      |            |
| Primary regulation (% per 30 seconds)   | +0  | +0   | +0   |      | +0                 | +0     |                    |       | AF   | 7          |
| Secondary regulation (% per minute)   | +0  | +0   | +0   |      | +0                 | +0     |                    |       | AF   | 7          |
| Minimum load (% of full load)   | +0  | +0   | +0   |      | +0                 | +0     |                    |       | AF   | 7          |
| Warm start-up time (hours)  | +0  | +0   | +0   |      | +0                 | +0     |                    |       | AF   | 7          |
| Cold start-up time (hours)  | +0  | +0   | +0   |      | +0                 | +0     |                    |       | AF   | 7          |
| <b>Environment</b>  |   |      |      |      |                    |        |                    |       |      |            |
| SO <sub>2</sub> (degree of desulphuring, %)   | +0  | +0   | +0   |      | +0                 | +0     |                    |       | AFG  | 8          |
| NO <sub>x</sub> (g per GJ fuel)   | +0  | +0   | +0   |      | +0                 | +0     |                    |       | AFG  | 8          |
| CH <sub>4</sub> (g per GJ fuel)   | +0  | +0   | +0   |      | +0                 | +0     |                    |       | AFG  | 8          |
| N <sub>2</sub> O (g per GJ fuel)  | +0  | +0   | +0   |      | +0                 | +0     |                    |       | AFG  | 8          |
| <b>Financial data</b>   |   |      |      |      |                    |        |                    |       |      |            |
| Nominal investment (M€/MW)  | 0.24  | 0.24 | 0.24 |      | 0.15               | 0.34   |                    |       | CF   | 4, 5, 6, 7 |
| - of which equipment  | -   | -    | -    |      | -                  | -      |                    |       |      |            |
| - of which installation   | -   | -    | -    |      | -                  | -      |                    |       |      |            |
| Fixed O&M (€/MW/year)   | +0  | +0   | +0   |      | +0                 | +8,000 |                    |       | ABF  | 7          |
| Variable O&M (€/MWh)  | +0  | +0   | +0   |      | +0                 | +0     |                    |       | ADF  | 7          |

**Notes:**

- A Values will generally be similar to those of the plant prior to Life Time Extension (LTE).
- B Values will depend on those of the plant prior to LTE, however the average fixed O&M cost may increase slightly for the extension period compared with the original life time to accommodate the necessary reinvestments during the extended life time.
- C Investment costs will vary largely, depending on the necessary scope of work. The indicated range represents typical cases where 20-25 years Danish coal power CHP plants have been life time extended to obtain additional 15 years life time (based mainly on budgetted values).
- D Variable O&M costs will in general be similar or a bit smaller to those of the plant prior to LTE. The reason for the small improvement is when you compare it to just before the LTE. When compared to the average over the lifetime the O&M costs will be similar.
- E Values will generally be similar to those of the plant prior to LTE. Average efficiencies over the lifetime will be similar to the plant prior to LTE, but the efficiencies just after the LTE will be better than that of the plant just before the LTE.
- F Values for year 2050 are not considered relevant since new coal fired power plants are not expected to be built
- G It is assumed that plant emissions prior to the LTE are within the legal limits.

### References

- [1] Electricity Generation Costs, Department of Energy and Climate Change (UK), Dec 2013 [Online]. Available: [https://www.gov.uk/government/uploads/system/uploads/attachment\\_data/file/269888/131217\\_Electricity\\_Generation\\_costs\\_report\\_December\\_2013\\_Final.pdf](https://www.gov.uk/government/uploads/system/uploads/attachment_data/file/269888/131217_Electricity_Generation_costs_report_December_2013_Final.pdf)
- [2] R. Ambrosini, Life extension of coal-fired power plants, IEA, Dec 2005.
- [3] AFTALE MELLEM DONG Energy Power A/S OG Aarhus Kommune VEDR. Betaling af omkostninger til levetidsforlængelse af Studstrupværkets produktionsblok 3 og fællesanlæg, Århus Kommune, April 2012. [Online]. Available: <http://www.aarhus.dk/~media/eDoc/C/1/2/C125711F0048D96EC12579C1004C66F3attach2.pdf>
- [4] Projected Costs of Generating electricity edition 2015, IEA, NEA and OECD, 2015
- [5] Baggrundsnotat omhandlende metode for Energinet.dk's forventninger til kraftværksudviklingen i Danmark, Energinet.dk, 27. august 2014 (Background note concerning method for Energinet.dk's expectations for power plant development in Denmark , Energinet.dk , August 27, 2014).
- [6] Studstrupværket kører videre på kul frem til 2015, Ingeniøren, 10. maj 2012, (Studstrupværket continues to run on coal until 2015, Engineer , May 10, 2012).
- [7] Ea Energy Analysis, based on experience from various commercial projects.
- [8] It is assumed by Ea Energy Analyses that plants emissions prior to the LTE is within the legal limits.

## 03 Rebuilding Large Coal Power Plants to Biomass

### Contact information:

Danish Energy Agency: Rikke Næraa, [rin@ens.dk](mailto:rin@ens.dk)

Author: Ea Energy Analyses

### Publication date

August 2016

### Amendments after publication date

| Date       | Ref.   | Description   |
|------------|--|---|
| June '19   | 03d Rebuilding coal plant to Biomass             | Added Datasheet d for rebuild coal fired plants to chips backpressure plant |
|            | 03a-b Rebuilding coal plant to Biomass           | Updated datasheets a and b for rebuild coal fired plants to wood pellets    |
| October 18 | 03 Rebuilding Large Coal Power Plants to Biomass | Datasheets updated  |

## Qualitative description

### Brief technology description

Existing coal power plants may be rebuilt for biomass combustion, mainly in order to reduce CO<sub>2</sub> emissions without discarding existing generating capacity. The conversion to biomass in existing pulverized coal fired power plants may be done partly by co-firing a fraction of biomass together with the coal, or by converting the plant fully to biomass. The data and descriptions in this chapter only consider the full conversion options.

The power plants for rebuilding are assumed to be of age approximately 25 years meaning that a life time extension will be necessary in any case. Thus, the expected costs of lifetime extension are included for those parts of the plant that remain in operation after the rebuilding. It is further assumed that the rebuilt power plant will have a technical life time of 15 years, i.e. the O&M costs will cover the necessary refurbishments in this period.

The necessary works and associated costs for life time extension and rebuilding of existing power plants will in any case vary over a large span since the original power plants are all unique in terms of technical design and condition.

Coal power plants can be modified for biomass in a number of ways. Here the following three concepts are considered:

- a) Wood pellets, existing boiler
- b) Wood chips, new boiler
- c) Wood chips, existing boiler

These options will determine the requirements for the necessary technical modifications and replacements of the fuel handling equipment, boiler systems etc. of the plants.

#### a) Wood pellets

The easiest and cheapest (concerning the investment costs) solution is to convert the fuel from coal to wood pellets, which is a fuel with the most similar characteristics to coal, meaning that the same boiler can be used. Pellets is a homogeneous and pre-dried fuel of various standardized qualities, produced from biomass material such as wood, wood residues, other energy crops or residues of agricultural production, etc., typically produced abroad and transported to the power plants in large vessels. The pellets have controlled water content, typically below 10% [1]. The energy

consumption in the production of the pellets is around 10% of the energy content of the finished product [2], whereas the energy consumption for transportation depends on e.g. the type of ship, the distance and whether or not the ship is returning empty or with cargo. Shipping of pellets from Canada consume around 4% of the energy content in the finished product (efficient ship and full cargo), whereas transportation from the Baltic countries consume approximately 1.5% of the energy content of the finished product [3].

The figure below shows a principle sketch of the plant and which elements are expected to be added, replaced, or refurbished. Among these are:

- New storage silos and transport systems for the pellets
- Coal mills, to be modified and with extended capacity due to lower calorific value
- Larger fans for pneumatic transport systems
- New burners
- Boiler modifications , e.g. soot blowers to avoid deposits
- Other life time extensions, as relevant

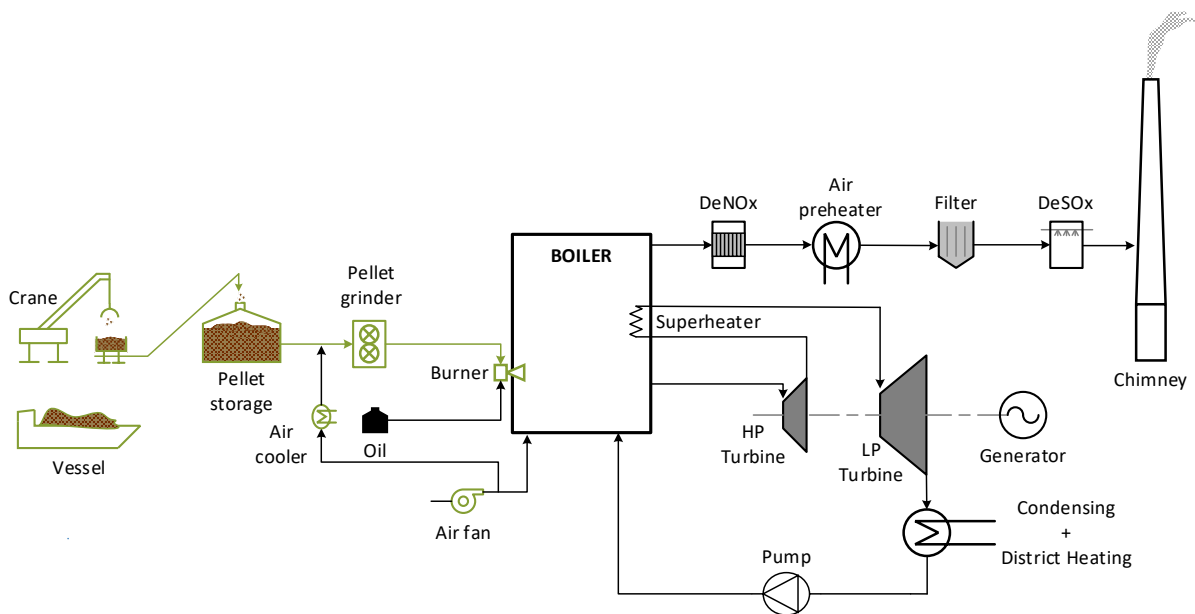

Figure

1: Sketch of a CHP plant converted to firing with wood pellets. The green elements indicate the equipment that needs to be added, replaced or refurbished.

The existing boilers, flue gas systems, and steam systems can be kept in operation with minor modifications done in connection with the life time extension. It should be considered to by-pass the desulphurization plant as the sulphur content in wood is much lower than in coal. This has been done on Amagerværket Unit 1 to attain higher efficiency. In such cases boiler efficiency and steam data will probably only be marginally affected. Since cold air is used for the fuel feeding less combustion air is heated in the air preheater, and subsequently the heat extracted from flue gas is less than in the original plant resulting in a minor reduction of the boiler efficiency. Application of flue gas condensation is not relevant due to the low water content of the pellets. In the boiler, increased formation of ash and slag deposits, e.g. corrosive chlorines, may normally be expected when shifting from coal to wood firing. This may be remedied by use of steam soot blowers. To improve the chemical processes and avoid deposits and dust formation, an amount of coal or fly ash from coal can be added to the boiler. The lower calorific value of wood compared with coal increases the necessary fuel amounts to approximately double volume. Storage of pellets requires new covered storage facilities. Therefore expansions of harbor facilities and land use for storage may be required. The possible additional costs for this are not considered.

It is here assumed that the boiler can be reused. In case existing boiler steam parameters are outdated or the boiler is worn out it can be beneficial to replace the boiler completely as done on Amagerværket Unit 1.

#### b) Wood chips, new boiler

Conversion of the fuel type from coal to wood chips requires major changes and is more time consuming and costly than conversion to pellets. However, this could be counterbalanced by a lower fuel price. One option for converting to wood chips is to install an entire new boiler. Wood chips are a less homogeneous fuel than pellets, with large variations in quality and size. Its water content is high, typically from 20% and up to more than 50%, and it may as well contain fractions of soil. The chipping can take place in the forest where smaller branches and treetops can also be used. Due to the low energy density and high water content wood chips are less suitable for transport over long distances and are most often locally sourced. However, logs can be transported by boat and chopped at the destination site.

The need for boiler replacement is due to the inability of the coal dust fired boiler to be adapted to the larger and inhomogeneous wood chips. For larger units > 200 MWth it is assumed that a circulating fluid bed (CFB) type furnace will be chosen (a chapter on large biomass circulating fluidized bed combustion systems (CFBC) will soon be included in the catalog), whereas bubbling fluid bed (BFB) and grate fired boilers are typically preferred for smaller units up to 150 MWth, but not feasible above this size due to physical limitations. For existing larger plants it is an option though, to build more than one grate fired boiler in parallel when converting to biomass. The data given here are based on the CFB type boiler. Due to the high water content in the fuel the boiler system will be equipped with flue gas condensation for increasing the heat output. The condensation will normally use the district heating return water, but further energy may be recovered by applying heat pumps (not considered in the data sheet).

The amount of condensate water is high due to the fuel's high moisture content. Therefore water treatment costs can be considerable.

Flue gas cleaning and dust filters need to be provided. Due to the lower combustion temperature in CFB the creation of NO<sub>x</sub> is lower than in other boilers [4, 5]. Still some kind of DeNO<sub>x</sub> plant probably is required. SCR (selective catalytic reduction) will probably be necessary to achieve the NO<sub>x</sub> emission limit value in the upcoming European standards<sup>6</sup>. A low duct tail end SCR can be integrated with flue gas cleaning [2]. Due to low sulfur content of woodchips, DeSO<sub>x</sub> is normally not required.

Further, the plant needs to be supplemented by a system for storage and handling of the wood chips, which can normally be stored outdoors. As for wood pellets expansions of harbor facilities and land use for storage may be required, but the possible additional costs for this are not considered here.

The figure below shows a principle sketch of the plant and which elements are expected to be added, replaced or refurbished. Among these are:

- New storage and transport systems for the wood chips
- New CFB boiler and air fans
- New high pressure turbine due to lower steam pressure. CFB boiler can also be made as super critical with high steam parameters
- New flue gas system, filters and condensation scrubber and probably also SCR
- Other life time extensions, as relevant

---

<sup>6</sup> LCP BREF (140 mg NO<sub>x</sub>/Nm<sup>3</sup> @ 6% O<sub>2</sub> for plant above 100 MWth)



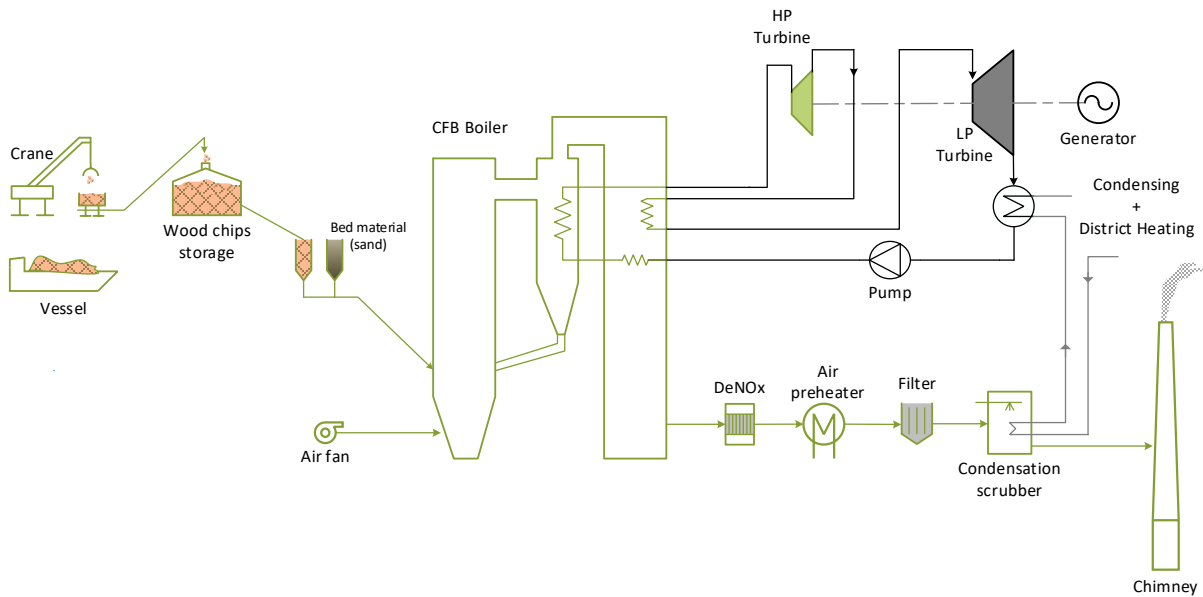

Figure 2: Sketch of a CHP plant converted to firing with wood chips with a new CFB boiler. The green elements indicate the equipment that needs to be added, replaced or refurbished.

c) Wood chips, existing boiler

Another option for converting to wood chips is to reuse the existing boiler but install a plant for processing the chips into dry and fine grained matter, i.e. comparable to the fuel obtained by grinding wood pellets.

Thus, the existing boilers, flue gas systems, and steam systems can be kept in operation with minor modifications done in connection with the life time extension.

The water content of the wood chips must be lowered to usually below 10%, which may be achieved by adding a separate wood chip fired furnace or by using heat from the boiler flue gas. Before the drying the wood chips must be ground down to smaller sizes e.g. in hammer mills, depending on the quality of the raw material. After the drying the final grinding takes place for the fuel to be suitable for the dust-type burners.

Due to the large fuel volumes the storage and preparation plant may constitute a considerable extension of the existing plant. In the cost estimates, no potential expansions of harbor facilities and land use for storage are considered.

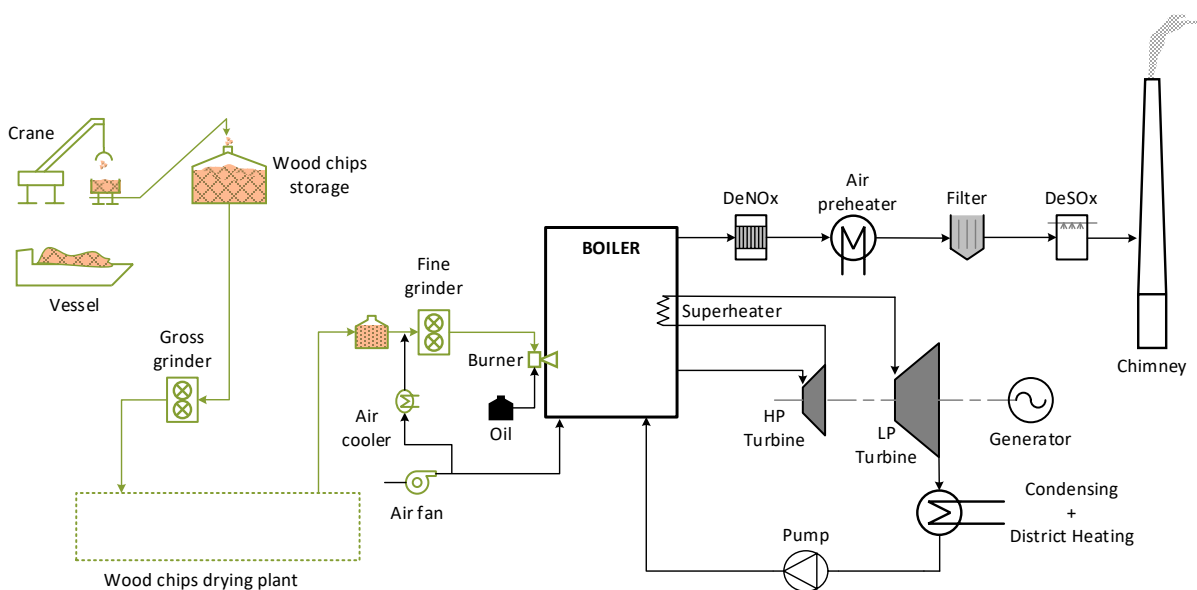

**Figure 3: Sketch of a CHP plant converted to firing with wood chips with its existing boiler. The green elements indicate the equipment that needs to be added, replaced or refurbished.**

As an alternative to converting the wood chips into pulverized fuel quality the boiler can be modified by installing a grate below the boiler. In such case the heat input on the grate is typically smaller than the original heat input and the plant is down rated accordingly.

#### Input

Primary fuels are biomass in the form of either a) dried and compressed wood pellets, or b) and c)

Wood chips.

#### Output

The output is electricity and heat for use in district heating systems.

#### Typical capacities

The capacity range considered is in the range of 200-400 MW<sub>e</sub>.

#### Regulation ability and other power system services

The regulation abilities will in most cases not change much, in case existing boilers of coal fired plants are rebuilt to biomass firing.

The regulation abilities of coal fired power plants with respect to primary and secondary load support are described in the Technology Catalogue item 01. The start-up times from cold state to initial generation for pulverized fuel (PF) and CFB boilers normally vary between 8 and 15 hours the higher end represent the CFB boilers. Typically, a power output of 25% of full capacity can be reached after 3 hours following the initial start-up time during which oil- or gas burners are used [6].

#### Start-up costs

The direct start-up costs include the fuel consumption for heating up boilers (which is not utilised for energy production), the electricity consumption, and other costs related to operation. The costs of a start-up also depend on the type of fuel used in the start-up period. As for a conventional plant it is normal to use oil or gas to pre-heat the boiler in a biomass converted plant, before the primary fuel is inserted. Thus, the direct start-up costs will not change much due to the shift of fuel from coal to biomass, assuming that fossil fuel could still be used for start-up purpose.

The indirect costs are the lost value corresponding to the lifetime reduction for one start up. For instance, during the heating-up, thermal and pressure variations will cause fatigue damage to components, and corrosion may increase in some areas due to e.g. condensation. This will depend on the initial plant.

#### Advantages/disadvantages

In general, rebuilding of coal fired power plants to biomass combustion is a relatively fast and cost effective way to reduce the use of fossil fuels (coal). Compared to building entire new units, investments are likely to be significantly lower. Also, the outage periods is likely to be shorter than if an entire new plant should be built at the same location as the one that is assumed rebuild. However, in case of building a new boiler and HP turbine, the advantage in time may not be significant.

One of the disadvantages is that the performance data will be more or less locked by those of the old plant, for instance the efficiencies will depend largely on the allowable steam temperature and pressure. The original plants may be 20-30 years old and therefore not fully live up to the standards of present technology regarding efficiencies etc. Compared to coal, the chemistry of wood combustion causes increased challenges with ash and slag formation and corrosion in the boiler. This makes it necessary to reduce the boiler and steam temperature slightly, and thereby the plant's electrical efficiency is typically also lowered a few percent.

The three rebuilding options have various advantages and disadvantages compared to each other. The use of pre-fabricated wood pellets offers a quick solution for rebuilding older coal power plant with less investment than the other options. On the other hand, the fuel costs are higher.

Wood chips are a cheaper fuel than wood pellets. However, in case of both replacing the boiler and building a fuel drying and processing plant, the investment is higher.

When installing a new boiler for combustion of wood chips, which have a relatively high water content, a higher heat efficiency can be obtained when recovering the condensation heat from the flue gas, though with a somewhat lower electric efficiency. Still, the overall fuel efficiencies may be higher and even above 100% (LHV).

In the case of a CFB-type boiler, and possibly also with converted boilers, the steam pressure is often lower than in the original plant and therefore the high pressure turbine has to be replaced with a new one. However a number of CFB suppliers are able to offer also super critical boilers. Otherwise, the pressure drop over the high pressure turbine will condense the steam too much, and the low pressure turbine will get steam that is too “wet” and will eventually break faster than it should.

It is common to add coal ashes or coal in the combustion of biomass to prevent slag formation and corrosion in the boiler, this will most likely make the ashes unsuitable for spreading in the environment. At the same time, the recycling of the ashes for use in concrete products, which is normal practice with coal ashes, is questionable with wood ashes due to its high alkali content. The ashes from firing with coal or biomass can be used for producing synthetic gypsum.

#### Environment

The environmental issues when using biomass as a fuel in rebuilt coal power plants are generally similar to those of new biomass plants. Central issues are emission of particulate matter, NO<sub>x</sub> emissions and condensate water. Existing plant configuration often results in higher cost for flue gas cleaning than for new plants.

Another environmental issue is heavy metals in ashes. The ashes from biomass combustion contain minerals that are valuable in agriculture and forestry, and may be recycled. This is subject to regulation involving chemical analysis and controlling concentrations of heavy metals. Especially the cadmium and lead concentrations in the ashes will limit the amounts that can be spread over a certain area per year.

There are several specific health and safety issues connected with the transportation, handling and storage of wood pellets and chips. These involve e.g. the risk of suffocation, self-ignition, explosion, and formation of poisonous molds in storages and transport systems.

#### Research and development perspectives

Among the areas for further research activities within wood firing is the emission control and handling of residues.

Improvements in operation and maintenance may be gained when further experience is obtained, e.g. in process and emissions control, reduced corrosion rates, material selection for use in boilers, etc. In a wider perspective, a major area for discussion and development is the issue of sustainability connected with the sourcing of the wood material for fueling rebuilt power plants.

#### Examples of Market Standard technology

Conversion to wood pellets:

**DONG Energy Avedøreværket Unit 1**, 254 MW<sub>e</sub>, ongoing, expected completed in 2016.

DONG Energy has converted several other power plant units to biomass, for example Skærbækværket in 2015-2017 and Herningværket in 2002 and 2009. [7].

**GDF Suez plant**, Poland, 205 MW<sub>e</sub> 2012.

**HOFOR Amagerværket Unit 1** pulverized fuel plant converted to wood pellets and a small fraction of straw pellets in 2009.

### Prediction of performance in the future

As the technologies for rebuilding power plants have reached a mature stage, only incremental improvements of processes and equipment can be expected. These are largely driven by the emission limitation requirements and therefore not likely to lead to significant cost reductions.

Specific operation and maintenance issues with large biomass units can still be improved along with further experience being gained, and this knowledge can be utilized for converted coal units as well.

In principle, rebuilding will only be interesting as long as existing coal power plants are available, which offer financially interesting investments in competition with other electricity generation technologies.

### Uncertainty

The relatively large uncertainty intervals in the investment costs for the rebuilding options reflect mainly the following, in order of magnitude:

- The existing power plants are quite different in terms of design, technical condition size etc. This will widely influence the necessary works for life time extension and adding of new equipment in connection with rebuilding projects.
- There is some uncertainty expected related to general variations of prices and markets in the energy sector, e.g. raw materials like steel and copper, and the supply situation in the construction sector.

### Quantitative description

The following datasheet shows the technical, environmental and financial data for the specific technology. For more explanation see the section about Quantitative description in the Guideline chapter. The boxes “uncertainty” indicate the uncertainty or range of the parameter. The uncertainty only applies to the row, and cannot be read vertically, i.e. the lower uncertainty of the investment cost does not apply to the lower uncertainty of the capacity.

Data sheets Wood pellets, existing boiler

| Technology  | 03 Rebuilding power plants from coal to biomass<br>a) Wood pellets, existing boiler, extraction plant |       |       |      |                    |       |                    |       |      |            |
|---|---|-------|-------|------|--------------------|-------|--------------------|-------|------|------------|
|   | 2015  | 2020  | 2030  | 2050 | Uncertainty (2020) |       | Uncertainty (2050) |       | Note | Ref        |
| <b>Energy/technical data</b>  |   |       |       |      |                    |       |                    |       |      |            |
|   |   |       |       |      | Lower              | Upper | Lower              | Upper |      |            |
| Generating capacity for one unit (MW)   | 300   | 300   | 300   |      | 200                | 400   |                    |       |      |            |
| Electricity efficiency (condensation mode for extraction plants). net (%). name plate     | -1  | -1    | -1    |      | -0                 | -2    |                    |       | ABCI | 10         |
| Electricity efficiency (condensation mode for extraction plants). net (%). annual average | -1  | -1    | -1    |      | -0                 | -2    |                    |       | ABCI | 10         |
| Cb coefficient (50°C/100°C)   | -0.02   | -0.02 | -0.02 |      | -0                 | -0.05 |                    |       | ABCI | 10         |
| Cv coefficient (50°C/100°C)   | +0  | +0    | +0    |      | -0.01              | +0.01 |                    |       | AC   | 10         |
| Forced outage (%)   | +0  | +0    | +0    |      | -1                 | +1    |                    |       | A    | 10         |
| Planned outage (weeks per year)   | +0  | +0    | +0    |      | +0                 | +0    |                    |       | A    | 10         |
| Technical lifetime (years)  | 15  | 15    | 15    |      |                    |       |                    |       | C    | 10         |
| Construction time (years)   | 2   | 2     | 2     |      | 1.5                | 2.5   |                    |       | C    | 10         |
| Space requirement (1000m2/MW)   | +0  | +0    | +0    |      | +0                 | +0    |                    |       | AD   |            |
| <b>Regulation ability</b>   |   |       |       |      |                    |       |                    |       |      |            |
| Primary regulation (% per 30 seconds)   | +0  | +0    | +0    |      | +0                 | +0    |                    |       | A    | 10         |
| Secondary regulation (% per minute)   | +0  | +0    | +0    |      | +0                 | +0    |                    |       | A    | 10         |
| Minimum load (% of full load)   | +0  | +0    | +0    |      | +0                 | +0    |                    |       | A    | 10         |
| Warm start-up time (hours)  | +0  | +0    | +0    |      | +0                 | +0    |                    |       | A    | 10         |
| Cold start-up time (hours)  | +0  | +0    | +0    |      | +0                 | +0    |                    |       | A    | 10         |
| <b>Environment</b>  |   |       |       |      |                    |       |                    |       |      |            |
| SO2 (degree of desulphuring. %)   | N.A.  | N.A.  | N.A.  |      | -                  | -     |                    |       | J    |            |
| NOx (g per GJ fuel)   | 20  | 21    | 18    |      | 19                 | 53    |                    |       | G    |            |
| CH4 (g per GJ fuel)   | 0   | 0     | 0     |      | 3.1                | 3.1   |                    |       | G    |            |
| N2O (g per GJ fuel)   | 1   | 1     | 1     |      | 0.8                | 0.8   |                    |       | G    |            |
| Particles (g per GJ fuel)   | 0.3   | 0.3   | 0.3   |      |                    |       |                    |       |      |            |
| <b>Financial data (in 2015€)</b>  |   |       |       |      |                    |       |                    |       |      |            |
| Nominal investment (M€/MWe)   | 0.50  | 0.50  | 0.50  |      | 0.35               | 0.80  |                    |       | CEK  | 10, 11, 12 |
| - of which equipment  | -   | -     | -     |      | -                  | -     |                    |       |      |            |
| - of which installation   | -   | -     | -     |      | -                  | -     |                    |       |      |            |
| Fixed O&M (€/MWe/year)  | +3350   | +3350 | +3350 |      | +1350              | +5350 |                    |       | AFK  | 10         |
| Variable O&M (€/MWh)  | +0.9  | +0.9  | +0.9  |      | +0.4               | +1.4  |                    |       | AFK  | 10         |
| <b>Technology specific data</b>   |   |       |       |      |                    |       |                    |       |      |            |
| Fixed O&M (€/MWhinput/year)   | +1350   | +1350 | +1350 |      | +550               | +2150 |                    |       | AFK  | 10         |
| Variable O&M (€/MWhinput)   | +0.36   | +0.36 | +0.36 |      | +0.16              | +0.56 |                    |       | AFK  | 10         |

**Notes:**

- A Value depend on the original plant. Value indicate the estimated change from the original value (unit is the same as the paramter).
- B Typically the electricity efficiency will be 1-2 % point lower than that of the plant prior to conversion. The thermal efficiency is typically unchanged, thus the Cb value decreases, meaning more heat is produced compared to electricity.
- C Values for year 2050 are not considered relevant since it is assumed that all coal fired plants in Denmark have been rebuilt or decommissioned.
- D Some additional under roof space (or silos) will be required for storage of pellets compared to coal (estimated 50%-100% extra m3 storage). But not more floor space (m2).
- E The nominal investment assumes that the original plant is aged and therefore include investment for a general life time extension campaign
- F The variable O&M costs will be similar to those of the original plant, however fixed O&M costs are likely to increase by 10-20%
- G Assumed the same emission values from the datasheet of new biomass plants (wood chips). See references and notes in the datasheet '09 Biomass CHP, Steam Turbine - Large steam turbine, Woodchips'.
- I It is assumed that plants that are refurbished in 2015 have an electric efficiency of 41% and a CB coefficient of 0.556. Plants refurbished in 2020 have an electric efficiency of 42% and a CB coefficient of 0.64. Plants refurbished in 2030 have an electric efficiency of 44% and a CB coefficient of 0.77. The estimates are made based on Danish CHP plants that are commissioned in 1990, 1995 and 2005.
- J It is assumed that that Flue Gas Desulphurization plant is bypassed (stopped) due to low Sulphur content in wood pellet fuel
- K O&M cost and CAPEX has been estimated by Ramboll in April 2019 based on input from DE/Ørsted and data from UK Department for Business, Energy & Industry strategy (BEIS) in their Electricity Generation Cost report from 2016.

Data sheets Wood chips, new boiler

| Technology  | 03 Rebuilding power plants from coal to biomass<br>b) Wood chips, new boiler, extraction plant |        |        |      |                    |        |                    |       |      |        |
|---|--|--------|--------|------|--------------------|--------|--------------------|-------|------|--------|
|   | 2015   | 2020   | 2030   | 2050 | Uncertainty (2020) |        | Uncertainty (2050) |       | Note | Ref    |
| <b>Energy/technical data</b>  |  |        |        |      | Lower              | Upper  | Lower              | Upper |      |        |
| Generating capacity for one unit (MW)   | 300  | 300    | 300    |      | 200                | 400    |                    |       |      |        |
| Electricity efficiency (condensation mode for extraction plants). net (%). name plate     | -1   | -1     | -1     |      | -0                 | -2     |                    |       | ABJ  | 10     |
| Electricity efficiency (condensation mode for extraction plants). net (%). annual average | -1   | -1     | -1     |      | -0                 | -2     |                    |       | ABJ  | 10     |
| Cb coefficient (50°C/100°C)   | -0.07  | -0.07  | -0.07  |      | -0.02              | -0.1   |                    |       | ABJ  | 10     |
| Cv coefficient (50°C/100°C)   | +0   | +0     | +0     |      | -0.01              | +0.01  |                    |       | A    | 10     |
| Forced outage (%)   | +0   | +0     | +0     |      | -1                 | +1     |                    |       | A    | 10     |
| Planned outage (weeks per year)   | +0   | +0     | +0     |      | +0                 | +0     |                    |       | A    | 10     |
| Technical lifetime (years)  | 15   | 15     | 15     |      |                    |        |                    |       | C    | 10     |
| Construction time (years)   | 2.5  | 2.5    | 2.5    |      | 2                  | 3      |                    |       | C    | 10     |
| Space requirement (1000m2/MW)   | +0.03  | +0.03  | +0.03  |      | +0.02              | +0.05  |                    |       | AD   | 10     |
| <b>Regulation ability</b>   |  |        |        |      |                    |        |                    |       |      |        |
| Primary regulation (% per 30 seconds)   | -2   | -0     | -0     |      | -0                 | -5     |                    |       | AI   | 10     |
| Secondary regulation (% per minute)   | -2   | -0     | -0     |      | -0                 | -5     |                    |       | AI   | 10     |
| Minimum load (% of full load)   | +0.05  | +0.05  | +0     |      | +0                 | +0.1   |                    |       | A    | 10     |
| Warm start-up time (hours)  | +0.5   | +0.5   | +0     |      | +0                 | +2     |                    |       | AI   | 10     |
| Cold start-up time (hours)  | +1   | +1     | +1     |      | +0                 | +2     |                    |       | AI   | 10     |
| <b>Environment</b>  |  |        |        |      |                    |        |                    |       |      |        |
| SO2 (degree of desulphuring. %)   | 98   | 98     | 98     |      | -                  | -      |                    |       |      |        |
| NO <sub>x</sub> (g per GJ fuel)   | 30   | 24     | 20     |      | 19                 | 53     |                    |       | G    |        |
| CH4 (g per GJ fuel)   | 3  | 2      | 2      |      | 0                  | 0.5    |                    |       | G    |        |
| N2O (g per GJ fuel)   | 10   | 8      | 6      |      | 2                  | 20     |                    |       | G    |        |
| Particles (g per GJ fuel)   | 0.3  | 0.3    | 0.3    |      |                    |        |                    |       |      |        |
| <b>Financial data (in 2015€)</b>  |  |        |        |      |                    |        |                    |       |      |        |
| Nominal investment (M€/MW)  | 1.6  | 1.6    | 1.6    |      | 1.3                | 2.1    |                    |       | CE   | 10, 12 |
| - of which equipment  | -  | -      | -      |      | -                  | -      |                    |       |      |        |
| - of which installation   | -  | -      | -      |      | -                  | -      |                    |       |      |        |
| Fixed O&M (€/MWe/year)  | 73,750   | 73,750 | 73,750 |      | 61,250             | 86,250 |                    |       | FK   | 10     |
| Variable O&M (€/MWh)  | 2.75   | 2.75   | 2.75   |      | 1.75               | 3.75   |                    |       | FK   | 10     |
| <b>Technology specific data</b>   |  |        |        |      |                    |        |                    |       |      |        |
| Fixed O&M (€/MWe/year)  | 29,500   | 29,500 | 29,500 |      | 24,500             | 34,500 |                    |       | FK   | 10     |
| Variable O&M (€/MWh)  | 1.1  | 1.1    | 1.1    |      | 0.7                | 1.5    |                    |       | FK   | 10     |

**Notes:**

- A Value depend on the original plant.
- B Typically the electricity efficiency will be 1-2 % point lower than that of the plant prior to conversion. The thermal efficiency will typically increase to around 105%. thus the Cb value decreases. meaning more heat is produced compared to electricity. This is mainly due to implementation of exhaust gas condenser.
- C Values for year 2050 are not considered relevant since it is assumed that all coal fired plants in Denmark have been rebuilt or decommissioned.
- D Some additional space will be required for storage of chips (estimated 50%-100% extra).
- E The nominal investment assumes that the original plant is aged and therefore include investment for a general life time extension campaign
- F The fixed O&M costs are likely to increase by 10-20%. whereas the variable O&M costs are likely to increase approx. 50%.
- G Emission values from the datasheet of new CFB biomass plants. See references and notes in the datasheet 'Large Biomass Circulating Fluidized Bed Combustion Systems (CFBC) for wood'.
- I The regulation time of the boiler will often increase due to slower burning of chips compared to pulverized fuel. Depending of the other thermal limitations in the cycle (e.g. in the turbines) this will have no change or an increase in the regulation time.
- J It is assumed that plants that are refurbished in 2015 have an electric efficiency of 41% and a CB coefficient of 0.56. Plants refurbished in 2020 have an electric efficiency of 42% and a CB coefficient of 0.64. Plants refurbished in 2030 have an electric efficiency of 44% and a CB coefficient of 0.77. The estimates are made based on Danish CHP plants that are commissioned in 1990, 1995 and 2005.
- K O&M cost are copied from 09 Large Wood Chip CHP corrected with efficiency. Note that all financial data are absolute values and not relative to coal.



Data sheets Wood chips, existing boiler, extraction plant

| Technology  | 03 Rebuilding power plants from coal to biomass<br>c) Wood chips, existing boiler, extraction plant |         |         |      |                    |         |                    |       |      |     |
|---|---|---------|---------|------|--------------------|---------|--------------------|-------|------|-----|
|   | 2015  | 2020    | 2030    | 2050 | Uncertainty (2020) |         | Uncertainty (2050) |       | Note | Ref |
| <b>Energy/technical data</b>  |   |         |         |      | Lower              | Upper   | Lower              | Upper |      |     |
| Generating capacity for one unit (MW)   | 300   | 300     | 300     |      | 200                | 400     |                    |       |      |     |
| Electricity efficiency (condensation mode for extraction plants), net (%), name plate     | -3  | -3      | -3      |      | -2                 | -4      |                    |       | ABI  | 10  |
| Electricity efficiency (condensation mode for extraction plants), net (%), annual average | -3  | -3      | -3      |      | -2                 | -4      |                    |       | ABI  | 10  |
| Cb coefficient (50°C/100°C)   | -0.07   | -0.07   | -0.07   |      | -0.02              | -0.1    |                    |       | ABI  | 10  |
| Cv coefficient (50°C/100°C)   | +0  | +0      | +0      |      | -0.01              | +0.01   |                    |       | A    | 10  |
| Forced outage (%)   | +0  | +0      | +0      |      | -1                 | +1      |                    |       | A    | 10  |
| Planned outage (weeks per year)   | +0  | +0      | +0      |      | +0                 | +0      |                    |       | A    | 10  |
| Technical lifetime (years)  | 15  | 15      | 15      |      |                    |         |                    |       | C    | 10  |
| Construction time (years)   | 2   | 2       | 2       |      | 1.5                | 2.5     |                    |       | C    | 10  |
| Space requirement (1000m2/MW)   | +0.04   | +0.04   | +0.04   |      | +0.03              | +0.06   |                    |       | AD   | 10  |
| <b>Regulation ability</b>   |   |         |         |      |                    |         |                    |       |      |     |
| Primary regulation (% per 30 seconds)   | +0  | +0      | +0      |      | +0                 | +0      |                    |       | A    | 10  |
| Secondary regulation (% per minute)   | +0  | +0      | +0      |      | +0                 | +0      |                    |       | A    | 10  |
| Minimum load (% of full load)   | +0  | +0      | +0      |      | +0                 | +0      |                    |       | A    | 10  |
| Warm start-up time (hours)  | +0  | +0      | +0      |      | +0                 | +0      |                    |       | A    | 10  |
| Cold start-up time (hours)  | +0  | +0      | +0      |      | +0                 | +0      |                    |       | A    | 10  |
| <b>Environment</b>  |   |         |         |      |                    |         |                    |       |      |     |
| SO <sub>2</sub> (degree of desulphuring, %)   | 98  | 98      | 98      |      | -                  | -       |                    |       | G    |     |
| NO <sub>x</sub> (g per GJ fuel)   | 30  | 24      | 20      |      | 19                 | 53      |                    |       | G    |     |
| CH <sub>4</sub> (g per GJ fuel)   | 3   | 2       | 2       |      | 3.1                | 3.1     |                    |       | G    |     |
| N <sub>2</sub> O (g per GJ fuel)  | 10  | 8       | 6       |      | 0.8                | 0.8     |                    |       | G    |     |
| Particles (g per GJ fuel)   | 0.3   | 0.3     | 0.3     |      |                    |         |                    |       | G    |     |
| <b>Financial data (in 2015€)</b>  |   |         |         |      |                    |         |                    |       |      |     |
| Nominal investment (M€/MW)  | 1.6   | 1.6     | 1.6     |      | 1.3                | 2.1     |                    |       | CE   | 10  |
| - of which equipment  | -   | -       | -       |      | -                  | -       |                    |       |      |     |
| - of which installation   | -   | -       | -       |      | -                  | -       |                    |       |      |     |
| Fixed O&M (€/MW/year)   | +14,175   | +14,175 | +14,175 |      | +12,600            | +15,750 |                    |       | F    | 10  |
| Variable O&M (€/MWh)  | +1,5  | +1,5    | +1,5    |      | +1                 | +2      |                    |       | F    | 10  |

**Notes:**

- A Value depend on the original plant.
- B Typically the electricity efficiency will be 3-4 % point lower than that of the plant prior to conversion. The thermal efficiency is increased to approximately 100% because of flue gas condensation in drying process, thus the Cb value decreases, meaning more heat is produced compared to electricity.
- C Values for year 2050 are not considered relevant since it is assumed that all coal fired plants in Denmark have been rebuilt or decommissioned.
- D Some additional space will be required for storage of chips (estimated 50%-100% extra) and for the drying plant.
- E The nominal investment assumes that the original plant is aged and therefore include investment for a general life time extension campaign
- F Both variable and fixed O&M costs are likely to increase by 40-50% from the original plant.
- G Assumed the same emission values from the datasheet of new biomass plants (wood chips). See references and notes in the datasheet '09 Biomass CHP, Steam Turbine - Large steam turbine, Woodchips'.
- I It is assumed that plants that are refurbished in 2015 have an electric efficiency of 41% and a CB coefficient of 0.57. Plants refurbished in 2020 have an electric efficiency of 42% and a CB coefficient of 0.64. Plants refurbished in 2030 have an electric efficiency of 44% and a CB coefficient of 0.77. The estimates are made based on Danish CHP plants that are commissioned in 1990, 1995 and 2005.

Data sheets Wood chips, existing boiler, back pressure plant

| Technology  | 03 Rebuilding power plants from coal to biomass<br>d) Wood chips, conversion small coal boiler, back pressure plant |      |      |      |                    |       |                    |       |      |     |
|---|---|------|------|------|--------------------|-------|--------------------|-------|------|-----|
|   | 2015  | 2020 | 2030 | 2050 | Uncertainty (2020) |       | Uncertainty (2050) |       | Note | Ref |
| <b>Energy/technical data</b>  |   |      |      |      |                    |       |                    |       |      |     |
|   |   |      |      |      | Lower              | Upper | Lower              | Upper |      |     |
| Generating capacity for one unit (MW)   | 70  |      |      |      | 50                 | 90    |                    |       | A, E | 13  |
| Electricity efficiency (condensation mode for extraction plants), net (%), name plate     | N/A   |      |      |      |                    |       |                    |       |      | 13  |
| Electricity efficiency (condensation mode for extraction plants), net (%), annual average | 27%   |      |      |      |                    |       |                    |       | B    | 13  |
| Cb coefficient (50°C/100°C)   | 0.35  |      |      |      |                    |       |                    |       | B    | 13  |
| Cv coefficient (50°C/100°C)   | N/A   |      |      |      |                    |       |                    |       |      | 13  |
| Forced outage (%)   | 3%  |      |      |      |                    |       |                    |       | C    | 13  |
| Planned outage (weeks per year)   | 3%  |      |      |      |                    |       |                    |       | C    | 13  |
| Technical lifetime (years)  | 15  |      |      |      |                    |       |                    |       |      |     |
| Construction time (years)   | N/A   |      |      |      |                    |       |                    |       |      |     |
| Space requirement (1000m2/MW)   | N/A   |      |      |      |                    |       |                    |       |      |     |
| <b>Regulation ability</b>   |   |      |      |      |                    |       |                    |       |      |     |
| Primary regulation (% per 30 seconds)   | 2   |      |      |      |                    |       |                    |       | C    | 13  |
| Secondary regulation (% per minute)   | 3   |      |      |      |                    |       |                    |       | C    | 13  |
| Minimum load (% of full load)   | 45  |      |      |      |                    |       |                    |       | C    | 13  |
| Warm start-up time (hours)  | 2   |      |      |      |                    |       |                    |       | C    | 13  |
| Cold start-up time (hours)  | 12  |      |      |      |                    |       |                    |       | C    | 13  |
| <b>Environment</b>  |   |      |      |      |                    |       |                    |       |      |     |
| SO <sub>2</sub> (degree of desulphuring, %)   | N/A   |      |      |      |                    |       |                    |       |      |     |
| NO <sub>x</sub> (g per GJ fuel)   | 30  |      |      |      |                    |       |                    |       | C    | 13  |
| CH <sub>4</sub> (g per GJ fuel)   | 3   |      |      |      |                    |       |                    |       | C    | 13  |
| N <sub>2</sub> O (g per GJ fuel)  | 10  |      |      |      |                    |       |                    |       | C    | 13  |
| Particles (g per GJ fuel)   | 0.3   |      |      |      |                    |       |                    |       | C    | 13  |
| <b>Financial data (in 2015€)</b>  |   |      |      |      |                    |       |                    |       |      |     |
| Nominal investment (M€/MW)  | N/A   |      |      |      |                    |       |                    |       |      |     |
| - of which equipment  | N/A   |      |      |      |                    |       |                    |       |      |     |
| - of which installation   | N/A   |      |      |      |                    |       |                    |       |      |     |
| Fixed O&M (€/MWe/year)  | 109,259   |      |      |      |                    |       |                    |       | D    |     |
| Variable O&M (€/MWh)  | 4.1   |      |      |      |                    |       |                    |       | D    |     |
| <b>Technology specific data</b>   |   |      |      |      |                    |       |                    |       |      |     |
| Fixed O&M (€/MWh_input/year)  | 29,500  |      |      |      |                    |       |                    |       | D    |     |
| Variable O&M (€/MWh_input)  | 1.1   |      |      |      |                    |       |                    |       | D    |     |

Notes:

- A Based on existing converted coal plant 50-90 MW capacity
- B The estimated electrical efficiency is 27 %. It is assumed that plants are equipped with Flue Gas Condensation having total efficiency of 105 %

- C Values are based on Data sheet for Wood Chips CHP, Large
- D O&M data are based data sheet 09 Wood chips CHP, Large, the specific values based on electricity has been corrected base on efficiency
- E Uncertainty estimate applies for 2015 value

## References

- [1] Biomass pelleting, European Biomass Industry Association, 2015. <http://www.eubia.org/index.php/about-biomass/biomass-pelleting>
- [2] Status overview of torrefaction technologies – IEA Bioenergy Task 32, Koppejan et. al, 2012.
- [3] Analysis of biomass prices – future Danish prices for straw, wood chips and wood pellets, Ea Energy Analyses for Danish Energy Agency, 2013.
- [4] Circulating fluidised bed technology - clean, efficient & fuel-flexible, Alstom, 2013. <http://alstomenergy.gepower.com/Global/Power/Resources/Documents/Brochures/circulating-fluidised-bed-boiler-technology-coal-oil-power-epslanguage=en-GB.pdf>
- [5] Dansk Gasteknisk Center A/S, 2013.
- [6] Assessment of startup period at coal-fired electric generating units, EPA 2013.
- [7] DONG Energy Power plans and experience in Biomass, Presentation Jesper Staal. [https://www.essent.eu/content/Images/90684\\_04\\_DONG%20plans%20in%20biomass\\_Jesper%20Staal.pdf](https://www.essent.eu/content/Images/90684_04_DONG%20plans%20in%20biomass_Jesper%20Staal.pdf)
- [8] Recirkulering af aske i skov -tekniske, økonomiske og økologiske aspekter, I. Callesen, S. Skov og N. Heding, Arbejdsrapport Skov & Landskab nr. 7-2004.
- [9] Informed by BWE A/S, Dec. 2015.
- [10] Ea Energy Analysis, based on experience from various commercial projects.
- [11] Government response to the consultation on proposals for the levels of banded support under the Renewables Obligation for the period 2013-17 and the Renewables Obligation Order 2012, UK Department of Energy and Climate Change, July 2012.
- [12] A strategy for converting coal fueled power plants to biomass, Future Metrics, September 2014
- [13] Ramboll, internall assessment

## 04 Gas Turbine, Simple-Cycle

### Contact information:

Danish Energy Agency: Rikke Næraa, [rin@ens.dk](mailto:rin@ens.dk)

Author: Dansk Gasteknisk Center

### Publication date

August 2016

### Amendments after publication date

| Date | Ref. | Description |
|------|------|-------------|
|      |      |             |

## Qualitative description

### Brief technology description

The major components of a simple-cycle (or open-cycle) gas turbine power unit are: a gas turbine, a gear (when needed) and a generator. For cogeneration (combined heat and power production), a flue gas heat exchanger (hot water or steam) is also installed, see the diagram below.

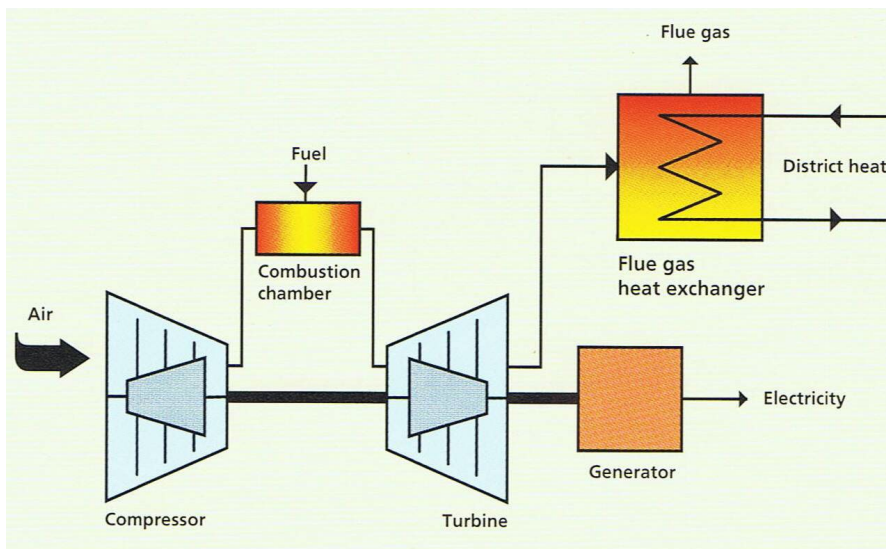

Figure 1 Diagram of a simple cycle plant designed for combined heat and power production.

If applying heat pumps for extra cooling of the exhaust gas, even higher total fuel efficiency can be reached. Depending on priorities, the flue gas heat pumps can be electrical or absorption type.

Simple cycle gas turbines can be used for preheating the feed water of steam power plants. This is the case at the Danish Avedøre 2 power station.

There are in general two types of gas turbines;

1. industrial turbines (also called heavy duty)
2. aero-derivative turbine

Industrial gas turbines differ from aero-derivative turbines in the way that the frames, bearings and blading are of heavier construction. Additionally, industrial gas turbines have longer intervals between services compared to the aero-derivatives.

Aero-derivative turbines benefit from higher efficiency than industrial ones and the most service-demanding module of the aero-derivative gas turbine can normally be replaced in a couple of days, thus keeping a high availability.

Gas turbines can be equipped with compressor intercoolers where the compressed air is cooled to reduce the power needed for compression. The use of integrated recuperators (preheating of the combustion air) to increase efficiency can also be made by using air/air heat exchangers - at the expense of an increased exhaust pressure loss. Gas turbine plants can have direct steam injection in the burner to increase power output through expansion in the turbine section (Cheng Cycle). Direct steam injection is not common for turbines in Denmark

Small (radial) gas turbines below 100 kWe are now on the market, the so-called micro-turbines. These are often equipped with preheating of combustion air based on heat from gas turbine exhaust (integrated recuperator) to achieve reasonable electrical efficiency (25 - 30 %).

### Input

Typical fuels are natural gas and light oil. Some gas turbines can be fuelled with other fuels, such as LPG, biogas etc., and some gas turbines are available in dual-fuel versions (gas/oil).

Gas fired gas turbines need an input pressure of the fuel (gas) of 20-60 bar, dependent on the gas turbine compression ratio, i.e. the entry pressure in the combustion chamber. Typically, aero derivative gas turbines need higher fuel (gas) pressure than industrial types.

### Output

Electricity and heat (optional). All heat output is from the exhaust gas and is extracted by a flue gas heat exchanger (heat recovery boiler).

The heat output is usually either as steam or hot water.

### Typical capacities

Simple-cycle gas turbines are available in the 30 kWe – 450 MWe range [1].

The enclosed data tables cover large scale (40 – 125 MW), medium and small scale (5 - 40 MW) installations. Data on micro gas turbines (0.03 – 0.100 MW) is also presented.

All data are for gas turbines operating in simple cycle cogeneration mode without flue gas condensation, if no additional notes are made.

### Regulation ability and other power system services

A simple-cycle gas turbine can be started and stopped within minutes, supplying power during peak demand. Because they are less power efficient than combined cycle plants, they are in most places used as peak or reserve power plants, which operate anywhere from several hours per day to a few dozen hours per year.

However, every start/stop has a measurable influence on service costs and maintenance intervals. As a rule-of-thumb, a start costs 10 hours in technical life expectancy [5].

The flue gas heat exchanger (heat recovery boiler) may lead to some constraints on start-up gradients. This can be solved by including a flue gas bypass.

Gas turbines are able to operate at part load. This reduces the electrical efficiency and at lower loads the emission of e.g. NO<sub>x</sub> and CO will increase. The increase in NO<sub>x</sub> emissions with decreasing load places a regulatory limitation on the regulation ability. This can be solved in part by adding de-NO<sub>x</sub> units.

The heat produced from cooling of the exhaust gas can be either hot water (for district heating or low-temperature process needs) or steam for process needs. Variations in steam production may be achieved by varying the gas turbine load, by supplementary firing in the heat recovery boiler or via a bypass stack.

To operate a simple cycle gas turbine of a cogeneration plant in power-only mode, the exhaust gas is directed to a bypass stack.

Most simple cycle gas turbine plants installations for CHP include short time heat storage. This leads to more flexibility in production planning.

### Advantages/disadvantages

#### *Advantages*

Simple-cycle gas turbine plants have short start-up/shut-down time, if needed. For normal operation, a hot start will take some 10 - 15 minutes [5,6]. Construction times for gas turbine based simple cycle plants are shorter than steam turbine plants [6].

#### *Disadvantages*

Concerning larger units above 15 MW, the combined cycle technology has so far been more attractive than simple cycle gas turbine, when applied in cogeneration plants for district heating [3]. Steam from other sources (e.g. waste fired boilers) can be led to the steam turbine part as well. Hence, the lack of a steam turbine can be considered a disadvantage for large-scale simple cycle gas turbines.

### Environment

Gas turbines have continuous combustion with non-cooled walls. This means a very complete combustion and low levels of emissions (other than NO<sub>x</sub>). Developments focusing on the combustors have led to low NO<sub>x</sub> levels as stated elsewhere. To lower the emission of NO<sub>x</sub> further, post-treatment of the exhaust gas can be applied, e.g. with SCR catalyst systems.

### Research and development perspectives

Increased efficiency for simple-cycle gas turbine configurations has also been reached through inter-cooling and recuperators. Research into humidification (water injection) of intake air processes (HAT) is expected to lead to increased efficiency due to higher mass flow through the turbine.

Additionally continuous development for less polluting combustion is taking place. Low-NO<sub>x</sub> combustion technology is assumed. Water or steam injection in the burner section may reduce the NO<sub>x</sub> emission, but also the total efficiency and thereby possibly the financial viability. The trend is more towards dry low-NO<sub>x</sub> combustion, which increases the specific cost of the gas turbine [3]

### Examples of market standard technology

The best technology on the market today is a medium size gas turbines with integrated recuperator that can reach approx. 38 % electrical efficiency (5 MWe unit).

### Prediction of performance and costs

Gas turbine technology is a well-proven commercial technology with numerous power generating installations worldwide, making simple cycle gas turbines a category 4 technology. Technological improvements are continuously being made; new materials, new surface treatments or improved production methods can lead to higher electrical efficiency, improved lifetime and less service needs.

Developments now also focus on broader gas quality acceptance during operation and improved dynamic performance.

The efficiency of the simple-cycle turbine can be increased, if inlet temperatures to the turbine section can be increased. Therefore development of ceramic materials that can withstand high temperatures used in the hot parts of the gas turbine is taking place.

However, the expectations for the gas turbine market in Denmark are limited, since gas turbines are currently predominantly used in the reserve power market. This means that no significant reductions in investment and/or operation/maintenance costs are expected to be seen in the years to come. In a longer perspective, gas turbines may become relevant for green gas based power production.

### Uncertainty

Uncertainty stated in the tables both covers differences related to the power span covered in the actual table and differences in the various products (manufacturer, quality level, extra equipment, service contract guarantees etc.) on the market.

A span for upper and lower product values is given for the year 2020 situation. No sources are available for the 2050 situation. Hence the values have been estimated by the authors.

### Additional remarks

Figures for service and maintenance costs are usually based on generated electricity. Service contract may also be on this basis; pricing may be influenced by the number of starts/stops.



## Data sheets

| Technology  | Gas turbine, simple cycle (large), back pressure |        |        |        |                    |       |                    |       |      |         |
|---|--|--------|--------|--------|--------------------|-------|--------------------|-------|------|---------|
|   | 2015   | 2020   | 2030   | 2050   | Uncertainty (2020) |       | Uncertainty (2050) |       | Note | Ref     |
| Energy/technical data   |  |        |        |        | Lower              | Upper | Lower              | Upper |      |         |
| Generating capacity for one unit (MW)   | 40 - 125   |        |        |        |                    |       |                    |       | F    |         |
| Electricity efficiency (condensation mode for extraction plants), net (%)                 | 41   | 42     | 43     | 45     | 38                 | 42    | 40                 | 44    |      | 6, 12   |
| Electricity efficiency (condensation mode for extraction plants), net (%), annual average | 39   | 40     | 41     | 43     | 36                 | 40    | 38                 | 42    |      | 6, 11   |
| Cb coefficient (50°C/100°C)   | 0.95   | 0.96   | 1      | 1      | 0.8                | 1.2   | 0.8                | 1.2   |      | 6, 12   |
| Cv coefficient (50°C/100°C)   | -  | -      | -      | -      | -                  | -     | -                  | -     | J    |         |
| Forced outage (%)   | 2  | 2      | 2      | 2      | 2                  | 3     | 2                  | 3     |      | 6       |
| Planned outage (weeks per year)   | 3  | 3      | 2.5    | 2.5    | 2                  | 3.5   | 1.5                | 3     |      | 6       |
| Technical lifetime (years)  | 25   | 25     | 25     | 25     | 25                 | >25   | 25                 | >25   | E    | 6, 7    |
| Construction time (years)   | 1.5  | 1.5    | 1.5    | 1.5    | 1                  | 2     | 1                  | 2     |      | 6       |
| Space requirement (1000m <sup>2</sup> /MW)  | 0.02   | 0.02   | 0.02   | 0.02   | 0.015              | 0.03  | 0.015              | 0.03  | G    | 7       |
| <b>Plant Dynamic Capabilities</b>   |  |        |        |        |                    |       |                    |       |      |         |
| Primary regulation (% per 30 seconds)   | 0  | 0      | 0      | 0      | 0                  | 0     | 0                  | 0     | I    |         |
| Secondary regulation (% per minute)   | 20   | 20     | 20     | 20     | 20                 | 50    | 20                 | 50    | C    | 6       |
| Minimum load (% of full load)   | 25   | 23     | 20     | 20     | 20                 | 25    | 20                 | 25    | A    | 6       |
| Warm start-up time (hours)  | 0.25   | 0.23   | 0.2    | 0.2    | 0.1                | 0.5   | 0.1                | 0.4   |      | 5, 6, 8 |
| Cold start-up time (hours)  | 0.5  | 0.5    | 0.5    | 0.5    | 0.4                | 1     | 0.4                | 1     |      | 5, 6, 8 |
| <b>Environment</b>  |  |        |        |        |                    |       |                    |       |      |         |
| SO <sub>2</sub> (degree of desulphuring, %)   | 0  | 0      | 0      | 0      | 0                  | 0     | 0                  | 0     |      |         |
| NO <sub>x</sub> (g per GJ fuel)   | 20   | 15     | 10     | 10     | 10                 | 30    | 7.5                | 20    | D    | 7, 9    |
| CH <sub>4</sub> (g per GJ fuel)   | 1.5  | 1.5    | 1.5    | 1.5    | 1                  | 8     | 1                  | 8     | G    | 9       |
| N <sub>2</sub> O (g per GJ fuel)  | 1.0  | 1.0    | 1.0    | 1.0    | 0.7                | 1.2   | 0.7                | 1.2   | G    | 9       |
| <b>Financial data</b>   |  |        |        |        |                    |       |                    |       |      |         |
| Nominal investment (M€/MW)  | 0.6  | 0.59   | 0.56   | 0.52   | 0.4                | 0.9   | 0.35               | 0.85  |      | 6, 10   |
| - of which equipment  | NA   | NA     | NA     | NA     | NA                 | NA    | NA                 | NA    | K    |         |
| - of which installation   | NA   | NA     | NA     | NA     | NA                 | NA    | NA                 | NA    | K    |         |
| Fixed O&M (€/MW/year)   | 20,000   | 19,500 | 18,600 | 18,000 | NA                 | NA    | NA                 | NA    | B    | 6       |
| Variable O&M (€/MWh)  | 4.5  | 4.4    | 4.2    | 4      | 4                  | 6     | 3                  | 5     |      | 6       |

| Technology  | Gas turbine, simple cycle (small and medium scale plant) , back pressure |        |        |        |                    |       |                    |       |      |         |
|---|--|--------|--------|--------|--------------------|-------|--------------------|-------|------|---------|
|   | 2015   | 2020   | 2030   | 2050   | Uncertainty (2020) |       | Uncertainty (2050) |       | Note | Ref     |
| Energy/technical data   |  |        |        |        | Lower              | Upper | Lower              | Upper |      |         |
| Generating capacity for one unit (MW)   | 5 - 40   |        |        |        |                    |       |                    |       | F    |         |
| Electricity efficiency (condensation mode for extraction plants), net (%)                 | 36   | 37     | 39     | 40     | 32                 | 40    | 34                 | 42    | G, H | 6, 12   |
| Electricity efficiency (condensation mode for extraction plants), net (%), annual average | 34   | 35     | 37     | 38     | 30                 | 38    | 32                 | 40    |      | 6, 11   |
| Cb coefficient (50°C/100°C)   | 0.71   | 0.73   | 0.8    | 0.8    | 0.61               | 0.8   | 0.7                | 0.9   |      | 6, 12   |
| Cv coefficient (50°C/100°C)   | -  | -      | -      | -      | -                  | -     | -                  | -     | J    |         |
| Forced outage (%)   | 2  | 2      | 2      | 2      | 2                  | 3     | 2                  | 3     |      | 6       |
| Planned outage (weeks per year)   | 3  | 2.8    | 2.5    | 2.5    | 2                  | 3.5   | 1.5                | 3     |      | 6       |
| Technical lifetime (years)  | 25   | 25     | 25     | 25     | 25                 | >25   | 25                 | >25   | E    | 6, 7    |
| Construction time (years)   | 1.5  | 1.5    | 1.5    | 1.5    | 1                  | 1.5   | 1                  | 1.5   |      | 6       |
| Space requirement (1000m2/MW)   | 0.04   | 0.04   | 0.04   | 0.04   | 0.03               | 0.07  | 0.03               | 0.07  | G    | 7       |
| <b>Plant Dynamic Capabilities</b>   |  |        |        |        |                    |       |                    |       |      |         |
| Primary regulation (% per 30 seconds)   | 0  | 0      | 0      | 0      | 0                  | 0     | 0                  | 0     | I    |         |
| Secondary regulation (% per minute)   | 20   | 20     | 20     | 20     | 20                 | 50    | 20                 | 50    | C    | 6       |
| Minimum load (% of full load)   | 25   | 23     | 20     | 20     | 20                 | 25    | 20                 | 25    | A    | 6       |
| Warm start-up time (hours)  | 0.25   | 0.23   | 0.2    | 0.2    | 0.1                | 0.5   | 0.1                | 0.4   |      | 5, 6, 8 |
| Cold start-up time (hours)  | 0.5  | 0.5    | 0.5    | 0.5    | 0.4                | 1     | 0.4                | 1     |      | 5, 6, 8 |
| <b>Environment</b>  |  |        |        |        |                    |       |                    |       |      |         |
| SO <sub>2</sub> (degree of desulphuring, %)   | 0  | 0      | 0      | 0      | 0                  | 0     | 0                  | 0     |      |         |
| NO <sub>x</sub> (g per GJ fuel)   | 20   | 15     | 10     | 10     | 10                 | 30    | 8                  | 20    | D    | 7, 9    |
| CH <sub>4</sub> (g per GJ fuel)   | 1.5  | 1.5    | 1.5    | 1.5    | 1                  | 8     | 1                  | 8     |      | 9       |
| N <sub>2</sub> O (g per GJ fuel)  | 1.0  | 1.0    | 1.0    | 1      | 0.7                | 1.2   | 0.7                | 1.2   |      | 9       |
| <b>Financial data</b>   |  |        |        |        |                    |       |                    |       |      |         |
| Nominal investment (M€/MW)  | 0.75   | 0.73   | 0.70   | 0.68   | 0.6                | 1     | 0.55               | 0.95  |      | 6, 10   |
| - of which equipment  | NA   | NA     | NA     | NA     | NA                 | NA    | NA                 | NA    | K    |         |
| - of which installation   | NA   | NA     | NA     | NA     | NA                 | NA    | NA                 | NA    | K    |         |
| Fixed O&M (€/MW/year)   | 20,000   | 19,500 | 18,600 | 18,000 | NA                 | NA    | NA                 | NA    | B    | 6       |
| Variable O&M (€/MWh)  | 5.5  | 5.4    | 5.1    | 4.6    | 5                  | 7     | 4                  | 6     |      | 6       |

| Technology  | Gas turbine, simple cycle (micro) , back pressure |      |      |      |                    |       |                    |       |      |        |
|---|---|------|------|------|--------------------|-------|--------------------|-------|------|--------|
|   | 2015  | 2020 | 2030 | 2050 | Uncertainty (2020) |       | Uncertainty (2050) |       | Note | Ref    |
| Energy/technical data   |   |      |      |      | Lower              | Upper | Lower              | Upper |      |        |
| Generating capacity for one unit (MW)   | 0.015 - 0.200                                     |      |      |      |                    |       |                    |       |      |        |
| Electricity efficiency (condensation mode for extraction plants), net (%)                 | 30  | 30   | 30   | 30   | 23                 | 32    | 25                 | 35    | M    | 7      |
| Electricity efficiency (condensation mode for extraction plants), net (%), annual average | 28  | 28   | 28   | 28   | 21                 | 29    | 23                 | 33    |      |        |
| Cb coefficient (50°C/100°C)   | 0.6   | 0.6  | 0.6  | 0.6  | 0.4                | 0.85  | 0.4                | 0.85  |      | 7, 13  |
| Cv coefficient (50°C/100°C)   | -   | -    | -    | -    | -                  | -     | -                  | -     | J    |        |
| Forced outage (%)   | 5   | 5    | 5    | 5    | NA                 | NA    | NA                 | NA    |      |        |
| Planned outage (weeks per year)   | NA  | NA   | NA   | NA   | NA                 | NA    | NA                 | NA    |      |        |
| Technical lifetime (years)  | 15  | 15   | 15   | 15   | 10                 | 20    | 10                 | 20    | L    |        |
| Construction time (years)   | 0.5   | 0.5  | 0.5  | 0.5  | 0.3                | 0.8   | 0.2                | 0.7   | L    | 13     |
| Space requirement (1000m2/MW)   | 0.06  | 0.06 | 0.06 | 0.06 | 0.05               | 0.15  | 0.05               | 0.15  |      | 7      |
| Plant Dynamic Capabilities  |   |      |      |      |                    |       |                    |       |      |        |
| Primary regulation (% per 30 seconds)   | 0   | 0    | 0    | 0    | 0                  | 0     | 0                  | 0     |      |        |
| Secondary regulation (% per minute)   | 0   | 0    | 0    | 0    | 0                  | 0     | 0                  | 0     |      |        |
| Minimum load (% of full load)   | 40  | 40   | 40   | 40   | 30                 | 50    | 25                 | 50    | L    | 7, 13  |
| Warm start-up time (hours)  | 0.25  | 0.25 | 0.25 | 0.25 | NA                 | NA    | NA                 | (NA)  |      |        |
| Cold start-up time (hours)  | 0.5   | 0.5  | 0.5  | 0.5  | NA                 | NA    | NA                 | (NA)  |      |        |
| Environment   |   |      |      |      |                    |       |                    |       |      |        |
| SO <sub>2</sub> (degree of desulphuring, %)   | 0   | 0    | 0    | 0    | 0                  | 0     | 0                  | 0     |      | 13     |
| NO <sub>x</sub> (g per GJ fuel)   | 10  | 10   | 10   | 10   | 6                  | 15    | 6                  | 15    |      | 7, 13  |
| CH <sub>4</sub> (g per GJ fuel)   | 6   | 6    | 6    | 6    | NA                 | NA    | NA                 | NA    |      | 13     |
| N <sub>2</sub> O (g per GJ fuel)  | NA  | NA   | NA   | NA   | NA                 | NA    | NA                 | NA    |      | 13     |
| Financial data  |   |      |      |      |                    |       |                    |       |      |        |
| Nominal investment (M€/MW)  | 1.2   | 1.2  | 1.1  | 1.0  | NA                 | NA    | NA                 | NA    |      | 13, 14 |
| - of which equipment  | 0.85  | 0.85 | 0.8  | 0.7  | NA                 | NA    | NA                 | NA    |      | 13, 14 |
| - of which installation   | 0.35  | 0.35 | 0.3  | 0.3  | NA                 | NA    | NA                 | NA    |      | 13, 14 |
| Fixed O&M (€/MW/year)   | NA  | NA   | NA   | NA   | NA                 | NA    | NA                 | NA    |      |        |
| Variable O&M (€/MWh)  | 15  | 15   | 14   | 13   | 10                 | 15    | 8                  | 15    |      | 13     |

### Notes:

- A Very low efficiency at low loads and often increased Nox emission
- B Insurance excluded, unknown. Daily start assumed
- C Power related
- D Based on Dry Low NOx (DLN) techniques
- E Technical- and design life most often > 25 years
- F Electrical output
- G Combined with DGC assumptions, CHP configuration
- H GT's (5 MWe) are available including internal recuperator; the electrical nominal efficiency is then 37 % (LCV basis)
- I No data available, no known use
- J Not relevant for this CHP configuration
- K No data available
- L DGC Estimate
- M Air preheating by internal recuperation included

## References

- [1] Major Gas Turbine Suppliers product information available on the Web, 2015 (Online).
- [2] Diesel & Gas Turbine World Wide Catalogue, Brookfield, US (annual publication).
- [3] Cogeneration and On-site Power Production, Ltd., Penwell International.
- [4] Opportunities for Micropower and Fuel Cell/Gas Turbine Hybrid Systems in Industrial Applications, A. D. Little, US, 2000.
- [5] Danish Gas Technology Centre, Analysis on gas engine and gas turbine dynamics, 2013.
- [6] Wärtsila Technical Journal in detail 02-2014.
- [7] Data specs from manufacturers, 2015 (Web).
- [8] Danish Gas Technology Centre, Analysis and discussion with manufacturers, April 2013.
- [9] Danish Gas Technology Centre, Environmental survey, 2012.
- [10] Smart Power Generation - The future of electricity production, J. Klimstra & M. Hotakainen, 2011.
- [11] IEA: Projected cost of generating electricity, 2010.
- [12] COWI 2015 input.
- [13] The Omes Project results, 2005.
- [14] WBDG-Publication, B. L. Capehart, Microturbines, 2014.

## 05 Gas Turbine Combined-Cycle

### Contact information:

Danish Energy Agency: Rikke Næraa, [rin@ens.dk](mailto:rin@ens.dk)

Energinet.dk: Rune Grandal, [rdg@energinet.dk](mailto:rdg@energinet.dk)

Author: Dansk Gasteknisk Center

### Publication date

August 2016

### Amendments after publication date

| Date         | Ref.                          | Description                              |
|--------------|-------------------------------|--|
| January 2018 | 05 Combined cycle gas turbine | Additional references have been included |

## Qualitative description

### Brief technology description

Main components of combined-cycle gas turbine (CC-GT) plants include: a gas turbine, a steam turbine, a gear (if needed), a generator, and a heat recovery steam generator (HRSG)/flue gas heat exchanger, see the diagram below.

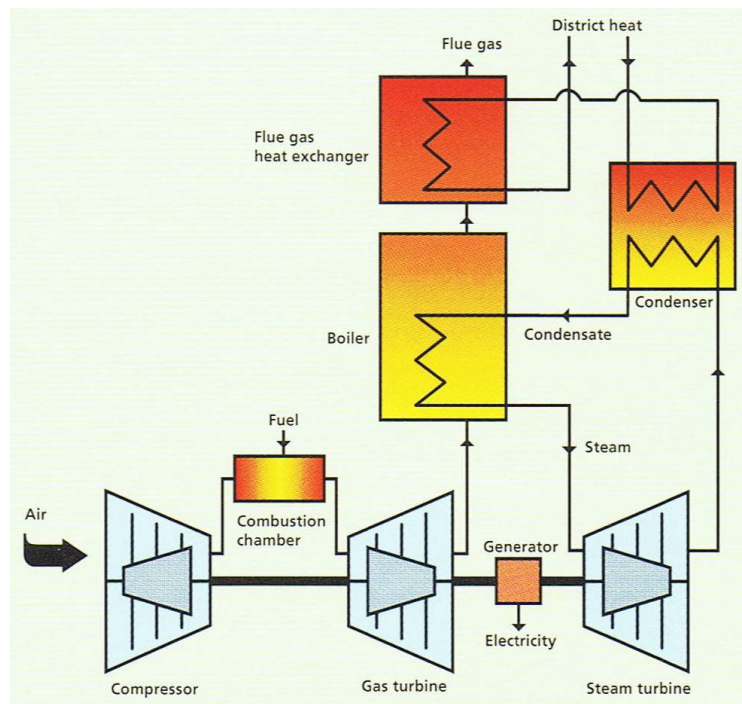

Figure 1 Diagram showing an example of a CC-GT plant designed for combined heat and power production.

The gas turbine and the steam turbine are shown driving a shared generator. In real plants, the two turbines might drive separate generators. Where the single-shaft configuration contributes with higher reliability, the multi-shaft has a slightly better overall performance.

The condenser is cooled by the return water from the district heating network. Since this water is afterwards heated by the flue gas from the gas turbine, the condensation temperature can be fairly low.

The overall energy efficiency depends on the flue gas stack temperature, while the electricity efficiency depends, besides the technical characteristics and the ambient conditions, on the district heating flow temperature. However, some plants do not have the option to sell district heating, and the condenser is therefore cooled by a sea/river/lake or a cooling tower.

If applying heat pumps for extra cooling of the exhaust gas, even higher total fuel efficiency can be reached. Depending on priorities, the flue gas heat pumps can be electrical or absorption type.

The heat recovery steam generator (HRSG) is defined through the number of pressure levels, each producing steam for the steam turbine. Small, medium and large scale units usually have one or two steam pressure stages whereas very large units may have three steam pressure stages. Steam is fed to the turbine both at the inlet and at a later stage between the two adjacent steam turbine sections; this is one of the special features of steam turbines in CC-GT.

Plants being able to shift between condensation mode (power only) and back-pressure mode (power and district heat) include a so-called extraction steam turbine. Such turbines are not available in small sizes, and dual-mode plants are therefore only feasible in large scale.

The power generated by the gas turbine is typically two to three times the power generated by the steam turbine. An extraction steam turbine shifting from full condensation mode at sea temperature to full back-pressure mode at district heat return temperature will typically lose about 10% of its electricity generation capacity. For example, a 40 MW gas turbine combined with a 20 MW steam turbine (condensation mode), loses 2 MW, (10% of 20 MW) or 3% of the total generating capacity (60 MW).

### Input

Typical fuels are natural gas and light oil. Some gas turbines can be fuelled with other fuels, such as LPG, biogas etc., and some gas turbines are available in dual-fuel versions (gas/oil).

Gas fired gas turbines need a fuel gas pressure of 20-60 bar, typically aero-derivative gas turbines need higher pressure than industrial gas turbines.

Additional steam from other sources may be fed to the steam turbine section.

### Output

Electricity and heat. The heat is most often supplied as hot water.

### Typical capacities

The enclosed datasheets cover large scale CC-GT (100 – 400 MW with extraction steam turbine) and medium scale (10 – 100 MW with back pressure steam turbine).

Most CC-GT units has an electric power of > 40 MWe

### Regulation ability and other power system services

CC-GT units are to some extent able to operate at part load. This will reduce the electrical efficiency and often increase the NO<sub>x</sub> emission.

If the steam turbine is not running, the gas turbine can still be operated by directing the hot flue gasses through a boiler designed for high temperature or into a bypass stack.

The larger gas turbines for CC-GT installations are usually equipped with variable inlet guide vanes, which will improve the part-load efficiencies in the 85-100 % load range, thus making the part-load efficiencies comparable with conventional steam power plants in this load range. Another means to improve part-load efficiencies is to split the total generation capacity into several CC-GTs. However, this will generally lead to a lower full load efficiency compared to one larger unit.

The NO<sub>x</sub> emission is generally increased during part load operation.

Some suppliers have developed CC-GT system designs enabling short start up both regarding the electrical output and the steam circuit as well.

Most CC-GT plants installations include a short time heat storage. This leads to more flexibility in production planning.

### Advantages/disadvantages

#### *Advantages*

Large gas turbine based combined-cycle units are world leading with regard to electricity production efficiency among fuel based power production.

Smaller CC-GT units have lower electrical efficiencies compared to larger units. Units below 20 MWe are few and will face close competition with single-cycle gas turbines and reciprocating engines.

Gas fired CC-GTs are characterized by low capital costs, high electricity efficiencies, short construction times and short start-up times.

#### *Disadvantages*

The economies of scale are substantial, i.e. the specific cost of plants below 200 MWe increases as capacity decreases.

The high air/fuel ratio for gas turbines leads to lower overall efficiency for a given flue gas cooling temperature compared to steam cycles and cogeneration based on internal combustion engines.

### Environment

Gas turbines have continuous combustion with non-cooled walls in the combustion chamber. This means a very complete combustion and low levels of emissions (except for NO<sub>x</sub>). Developments focusing on the combustor(s) have led to low NO<sub>x</sub> levels.

Flue gas post-treatment can consist of SCR catalyst systems etc.

### Research and development perspectives

Continuous research is done concerning higher inlet temperature at first turbine blades to achieve higher electricity efficiency. This research is focused on materials and/or cooling of blades.

Continuous development for less polluting combustion is taking place. Increasing the turbine inlet temperature may increase the NO<sub>x</sub> production. To keep a low NO<sub>x</sub> emission different options are at hand or are being developed, i.e. dry low-NO<sub>x</sub> burners, catalytic burners etc.

Development to achieve shorter time for service is also being done.

### Examples of market standard technology

Large CC-GT units have demonstrated an electrical efficiency of 60 % (LHV reference). Systems are now being offered and built with an electrical efficiency close to 62 %. The units are large units with an output in the 500 – 600 MWe [3].

In 2009, Eon opened one of the most efficient power plants in Europe, the CHP plant Öresundsverket in Malmö, Sweden. The 440 MW CC-GT has an electrical efficiency of 58% and an overall fuel efficiency in full cogeneration mode of 90%. The total investment figure for the project was €300 million [12].

### Prediction of performance and costs

Gas turbine based combined cycle plants are a well-proven, widespread and available technology, making CC-GT a category 4 technology. Improvements are still being made primarily on the gas and steam turbines used. Developments for faster load response and dynamic capabilities are now also in focus. In [13] examples is given for a large (>250 MWe) CC-GT plant with full GT power in less than 15 minutes and approx. 70 % power supply from the steam turbine. Full steam turbine power is achieved in less than one hour.

The expected market in Denmark is limited and declining for the time being. This means that no significant reductions in investment and/or operation/maintenance cost is expected in the years to come. In a longer perspective, gas turbines or gas turbine combined cycle plants may become relevant for green gas based balancing power.

**Uncertainty**

Uncertainty stated in the tables both covers differences related to the power span covered in the actual table and differences between the various products (manufacturer, quality level, extra equipment, service contract guarantees etc.) on the market.

A span for upper and lower product values is given for the year 2020 situation. No sources are available for the 2050 situation. Hence the values have been estimated by the authors.

**Additional remarks**

The main rotating parts (the gas turbine, steam turbine and the generator) tend to account for around 45-50% of the investment costs (EPC price), the heat recovery steam generator, condenser and cooling system for around 20%, the balance of plant components for around 15%, the civil works for around 15% and the remainder being miscellaneous other items [10].

**Data sheets**

| Technology  | Gas turbine, combined cycle, extraction plant |      |      |      |                    |       |                    |       |      |             |
|---|---|------|------|------|--------------------|-------|--------------------|-------|------|-------------|
|   | 2015  | 2020 | 2030 | 2050 | Uncertainty (2020) |       | Uncertainty (2050) |       | Note | Ref         |
| Energy/technical data   |   |      |      |      | Lower              | Upper | Lower              | Upper |      |             |
| Generating capacity for one unit (MW)   | 100 - 500                                     |      |      |      |                    |       |                    |       | F    |             |
| Electricity efficiency (condensation mode for extraction plants), net (%)                 | 58  | 59   | 61   | 63   | 55                 | 61    | 58                 | 65    |      | 5           |
| Electricity efficiency (condensation mode for extraction plants), net (%), annual average | 55  | 56   | 58   | 60   | 52                 | 58    | 55                 | 62    |      | 5, 9        |
| Cb coefficient (50°C/100°C)   | 1.7   | 1.8  | 2    | 2.2  | 1.5                | 2.2   | 1.5                | 2.4   |      |             |
| Cv coefficient (50°C/100°C)   | 0.15  | 0.15 | 0.15 | 0.15 | N.A                | N.A   | N.A                | N.A   | J    |             |
| Forced outage (%)   | 3   | 3    | 3    | 3    | 2                  | 4     | 2                  | 4     |      | 5           |
| Planned outage (weeks per year)   | 2.5   | 2.3  | 2    | 2    | 2                  | 4     | 2                  | 4     |      | 5           |
| Technical lifetime (years)  | 25  | 25   | 25   | 25   | 25                 | >25   | 25                 | >25   | E    | 5, 3        |
| Construction time (years)   | 2.5   | 2.5  | 2.5  | 2.5  | 2                  | 3     | 2                  | 3     |      | 5           |
| Space requirement (1000m2/MW)   | 0.02  | 0.02 | 0.02 | 0.02 | 0.015              | 0.03  | 0.015              | 0.03  | G    | 3           |
| <b>Plant Dynamic Capabilities</b>   |   |      |      |      |                    |       |                    |       |      |             |
| Primary regulation (% per 30 seconds)   | -   | -    | -    | -    | -                  | -     | -                  | -     | K    |             |
| Secondary regulation (% per minute)   | 15  | 15   | 15   | 15   | 5                  | 15    | 5                  | 15    |      | 5, 3, 11    |
| Minimum load (% of full load)   | 40  | 40   | 40   | 40   | 30                 | 50    | 30                 | 50    | A    | 5, 3, 11    |
| Warm start-up time (hours)  | 1   | 1    | 1    | 1    | 0.5                | 1.5   | 0.5                | 1.5   | H    | 5, 6, 1, 11 |
| Cold start-up time (hours)  | 2.5   | 2.5  | 2.5  | 2    | 2                  | 5     | 1.5                | 5     |      | 5, 6, 1, 11 |



| <b>Environment</b>                          |        |        |        |        |        |        |        |        |   |      |
|---|--------|--------|--------|--------|--------|--------|--------|--------|---|------|
| SO <sub>2</sub> (degree of desulphuring, %) | 0      | 0      | 0      | 0      | 0      | 0      | 0      | 0      |   |      |
| NO <sub>x</sub> (g per GJ fuel)             | 20     | 15     | 10     | 8      | 10     | 30     | 5      | 15     | D | 3, 7 |
| CH <sub>4</sub> (g per GJ fuel)             | 1.5    | 1.5    | 1.5    | 1.5    | 1      | 8      | 1      | 8      | G | 7    |
| N <sub>2</sub> O (g per GJ fuel)            | 1      | 1      | 1      | 1      | 0.7    | 1.2    | 0.7    | 1.2    | G | 7    |
| <b>Financial data</b>                       |        |        |        |        |        |        |        |        |   |      |
| Nominal investment (M€/MW)                  | 0.9    | 0.88   | 0.83   | 0.8    | 0.8    | 1.2    | 0.7    | 1.1    |   | 5, 8 |
| - of which equipment                        | 0.7    | 0.68   | 0.64   | 0.61   | 0.65   | 1.02   | 0.6    | 0.95   |   | 10   |
| - of which installation                     | 0.2    | 0.20   | 0.19   | 0.19   | 0.15   | 0.18   | 0.1    | 0.15   |   | 10   |
| Fixed O&M (€/MW/year)                       | 30,000 | 29,300 | 27,800 | 26,000 | 25,000 | 35,000 | 20,000 | 30,000 | B | 5    |
| Variable O&M (€/MWh)                        | 4.5    | 4.4    | 4.2    | 4      | 3      | 7      | 3      | 7      |   | 5    |

| Technology  | Gas turbine, combined cycle (back-pressure) |        |        |        |                    |        |                    |        |      |             |
|---|---|--------|--------|--------|--------------------|--------|--------------------|--------|------|-------------|
|   | 2015  | 2020   | 2030   | 2050   | Uncertainty (2020) |        | Uncertainty (2050) |        | Note | Ref         |
| Energy/technical data   |   |        |        |        | Lower              | Upper  | Lower              | Upper  |      |             |
| Generating capacity for one unit (MW)   | 10 -100                                     |        |        |        |                    |        |                    |        | F    |             |
| Electricity efficiency (condensation mode for extraction plants), net (%)                 | 50  | 51     | 53     | 55     | 42                 | 55     | 45                 | 58     |      | 5           |
| Electricity efficiency (condensation mode for extraction plants), net (%), annual average | 47  | 48     | 50     | 52     | 39                 | 52     | 42                 | 55     |      | 5, 9        |
| Cb coefficient (50°C/100°C)   | 1.2   | 1.3    | 1.4    | 1.55   | 0.9                | 1.6    | 1.1                | 1.7    |      |             |
| Cv coefficient (50°C/100°C)   | -   | -      | -      | -      | -                  | -      | -                  | -      | L    |             |
| Forced outage (%)   | 3   | 3      | 3      | 3      | 2                  | 4      | 2                  | 4      |      | 5           |
| Planned outage (weeks per year)   | 2.5   | 2.3    | 2      | 2      | 2                  | 4      | 1.5                | 4      |      | 5           |
| Technical lifetime (years)  | 25  | 25     | 25     | 25     | 25                 | >25    | 25                 | >25    | E    | 5, 3        |
| Construction time (years)   | 2.5   | 2      | 2      | 2      | 2                  | 3      | 2                  | 3      |      | 5           |
| Space requirement (1000m2/MW)   | 0.025                                       | 0.025  | 0.025  | 0.025  | 0.019              | 0.038  | 0.019              | 0.038  | G    | 3           |
| <b>Plant Dynamic Capabilities</b>   |   |        |        |        |                    |        |                    |        |      |             |
| Primary regulation (% per 30 seconds)   | -   | -      | -      | -      | -                  | -      | -                  | -      | I    |             |
| Secondary regulation (% per minute)   | 15  | 15     | 15     | 15     | 5                  | 15     | 5                  | 15     | C, M | 5, 3, 11    |
| Minimum load (% of full load)   | 40  | 40     | 40     | 40     | 30                 | 50     | 30                 | 50     | A    | 5, 3, 11    |
| Warm start-up time (hours)  | 1   | 1      | 1      | 1      | 0.5                | 1.5    | 0.5                | 1.5    | H    | 5, 6, 1, 11 |
| Cold start-up time (hours)  | 2.5   | 2.5    | 2.5    | 2      | 2                  | 5      | 1.5                | 5      |      | 5, 6, 1, 11 |
| <b>Environment</b>  |   |        |        |        |                    |        |                    |        |      |             |
| SO <sub>2</sub> (degree of desulphuring, %)   | 0   | 0      | 0      | 0      | 0                  | 0      | 0                  | 0      |      |             |
| NO <sub>x</sub> (g per GJ fuel)   | 20  | 15     | 10     | 8      | 10                 | 30     | 5                  | 15     | D    | 3, 7        |
| CH <sub>4</sub> (g per GJ fuel)   | 1.5   | 1.5    | 1.5    | 1.5    | 1                  | 8      | 1                  | 8      | G    | 7           |
| N <sub>2</sub> O (g per GJ fuel)  | 1   | 1      | 1      | 1      | 0.7                | 1.2    | 0.7                | 1.2    | G    | 7           |
| <b>Financial data</b>   |   |        |        |        |                    |        |                    |        |      |             |
| Nominal investment (M€/MW)  | 1.3   | 1.3    | 1.2    | 1.1    | 1.1                | 1.8    | 0.9                | 1.6    |      | 5, 9        |
| - of which equipment  | 1   | 1.0    | 0.9    | 0.8    | 0.8                | 1.4    | 0.65               | 1.25   |      | 10          |
| - of which installation   | 0.3   | 0.3    | 0.3    | 0.3    | 0.3                | 0.4    | 0.25               | 0.35   |      | 10          |
| Fixed O&M (€/MW/year)   | 30,000                                      | 29,300 | 27,800 | 26,000 | 25,000             | 35,000 | 20,000             | 30,000 | B    | 5           |
| Variable O&M (€/MWh)  | 4.5   | 4.4    | 4.2    | 4      | 3                  | 7      | 3                  | 7      |      | 5           |

### Notes:

- A Low efficiency at low loads and often increased NOx emission
- B Limited availability of data
- C Power related
- D Based on Dry Low NOx (DLN) techniques
- E Technical- and design life most often > 25 years
- F Electrical output
- G CHP configuration, Including DGC assumptions
- H Manufacturers says down to 30 minute
- I No data available
- J Data on Cv from the 2012 version roughly adjusted for higher electricity efficiency
- K No known use
- L No Relevance for Back Pressure Lay Out
- M Upward regulation is typically 10 - 15 %/min, while downward regulation is > 30 % /min

### References

- [1] Danish Gas Technology Centre, Analysis on Gas Engine and Gas Turbine Dynamics, 2013.
- [2] Major Gas Turbine Suppliers product information available on the Web, 2015 [Online].
- [3] Data specs from manufacturers (Web), 2015.
- [4] Opportunities for Micropower and Fuel Cell/Gas Turbine Hybrid Systems in Industrial Applications, A. D. Little, US, 2000.
- [5] Wärtsila Technical Journal in detail 02-2014.
- [6] Danish Gas Technology Centre, Analysis and discussion with manufacturers, April 2013.
- [7] Danish Gas Technology Centre, Environmental survey, 2012.
- [8] Smart Power Generation - The future of electricity production, J. Klimstra & M. Hotakainen, 2011.
- [9] IEA: Projected cost of generating electricity, 2010.
- [10] UK Electricity Generation Costs Update, M.M. Donald, June 2010.
- [11] Siemens: Data on GT-CC, 2010.
- [12] EuroHeat&Power, vol. 6, III/2009
- [13] Siemens Flex-Plant™ CC-GT concepts, presentations 2013

## 06 Gas Engines

### Contact information:

Danish Energy Agency: Rikke Næraa, [rin@ens.dk](mailto:rin@ens.dk)

Energinet.dk: Rune Grandal, [rdg@energinet.dk](mailto:rdg@energinet.dk)

Author: Dansk Gasteknisk Center

### Publication date

August 2016

### Amendments after publication date

| Date         | Ref.           | Description                       |
|--------------|----------------|-----------------------------------|
| January 2018 | 06 Gas engines | Reference sheet have been updated |

## Qualitative description

### Brief technology description

A gas engine for co-generation of heat and power drives an electricity generator for the power production. Electrical efficiency up to 45- 48 % can be achieved. The engine cooling water (engine cooling, lube oil and turbocharger intercooling) and the hot exhaust gas can be used for heat generation, e.g. for district heating or low-pressure steam.

In district heating systems with low return temperatures both sensible and latent heat in the exhaust gas can be recovered by using a condensing cooler as the final cooling of the flue gasses and a total efficiency of approx. 96-98% can be reached. If applying heat pumps for extra cooling of the exhaust gas system, 5-7% higher total efficiency can be reached. The flue gas heat pumps can be electrical or absorption type.

Two combustion concepts are available for spark ignition engines; lean-burn and stoichiometric combustion engines. Lean-burn engines have a high air/fuel-ratio. The combustion temperature and hence the NO<sub>x</sub> emission is thereby reduced. The engines can be equipped with oxidation catalysts for CO-reduction.

In stoichiometric combustion engines, the amount of air is just sufficient for (theoretically) complete combustion. For this technology, the NO<sub>x</sub> emission must be reduced in a 3-way catalyst. Only few of such engines are used for combined heat and power production in Denmark. These engines are usually in the lowest power range (< 150 kWe).

Pre-chamber lean-burn combustion system is a common technology for engines with a bore size typically larger than 200 mm. This technology helps to maximize electrical efficiency and increases combustion stability along with low NO<sub>x</sub> emissions.

Another ignition technology is used in dual-fuel engines. A dual-fuel engine (diesel-gas) with pilot oil injection is a gas engine that - instead of spark plugs - uses a small amount of light oil (1 - 6% ) to ignite the air-gas mix by compression (as in a diesel engine). Dual fuel engines can often operate on diesel oil alone as well as on gas with pilot oil for ignition.

More than 800 gas engines for combined heat and power production are installed in Denmark [4].

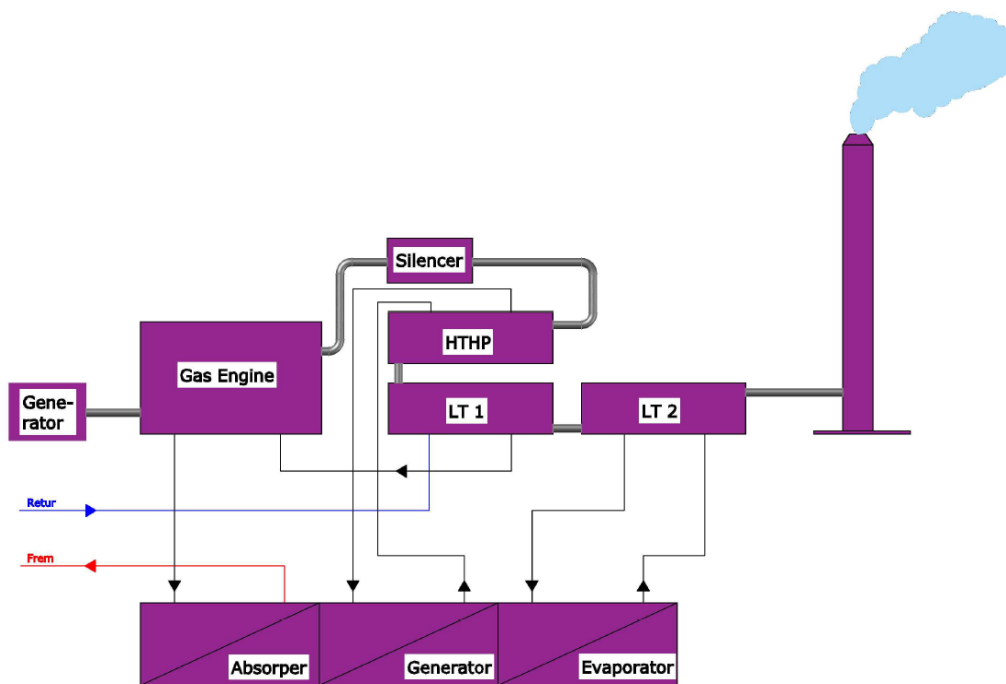

Figure 1 A gas engine based cogeneration unit with heat recovery boilers and an absorption heat pump to obtain a high heat production and highest possible overall efficiency. The heat pump is steam driven [9].

### Input

Gas, e.g. natural gas, biogas, landfill gas, special gas and syngas (from thermal gasification) can be input to gas engines. Multi-fuel engines are also on the market, and installations are in service in Denmark and abroad.

In recent years, engines have been developed to use gasses with increasingly lower heating values.

### Output

Electricity and heat (district heat; low-pressure steam; industrial drying processes; absorption cooling) are output of the gas engine.

### Typical capacities

5 kW<sub>e</sub> - 10 MW<sub>e</sub> per engine.

### Regulation ability and other power system services

Gas engines can start faster than most other electricity production technologies. For many engines 5-15 minutes are needed. Large gas engines have been successfully developed and tested for start to full electrical load in less than one minute. Engines have been developed for fuel switch during operation [7].

Part load is possible with only slightly decreased electric efficiency. The dual-fuel engines have the least decrease of efficiency at part load. Gas engines have better part load characteristics than gas turbines.

To operate a gas engine in power-only mode, the exhaust gas can be emitted directly to the atmosphere without heat extraction (but with de-NO<sub>x</sub> if required), whereas engine heat (about 50% of total heat) must be removed by a cooler. Approximately 10% of O&M costs can be saved in power-only mode [7].

Most gas engine based CHP plants installations include a short time heat storage. This leads to more flexibility in production planning.

### Advantages/disadvantages

#### *Advantages*

Gas engines are known and proven technology making it a highly reliable technology.

Gas engines can operate on moderate gas pressures. Gas engines can be supplied by a gas pressure of less than 1 bar(g). The pre-chamber lean-burn technology often requires a pressure for the pre-chambers of approx. 4 bar(g).

#### *Disadvantages*

Gas engines cannot be used to produce considerable amounts of high-pressure steam, as approx. 50 % of the waste heat is released at lower temperatures.

### Environment

Spark ignition engines comply with national regulations within EU by using catalyst and/or lean-burn technology to reduce the NO<sub>x</sub> emission.

The content of other air pollutants than NO<sub>x</sub> in the flue gas from a gas engine is generally low.

### Research and development perspectives

Multi-fuel or flexible fuel operation has been introduced, and R&D efforts are continuously put into this. Engines with almost instantaneous shift from gas to diesel and vice versa have been developed and demonstrated.

Short start-up, fast load response and other grid services are becoming more important as more fluctuating power sources are supplying power grids. Gas engines have a potential for supplying such services, and R&D efforts are put into this.

R&D in further emission reduction is continuously taking place; biogas and other such gasses may lead to new catalytic post treatment solutions.

### Examples of market standard technology

Best available technology from an efficiency point of view will be a large gas engine with approx. 48-50 % electrical efficiency and a total fuel efficiency of some 106% if fitted with an absorption heat pump using the outlet flue gas as heat source.

Engine based cogeneration units can be fitted with a small low pressure steam turbine for extra power generation.

From a grid service point of view (power balancing and backup) engines with a start to full electrical load in less than one minute is the best available technology.

### Prediction of performance and costs

Cogeneration based on gas engines is a proven and commercial technology in Denmark and abroad. Development still takes place mostly related to advanced control and diagnostic systems, making gas engines a category 4 technology. Development also takes place related to efficiency improvements, auxiliary equipment as heat pumps and/or heat driven cooling systems (tri-generation).

Gas engines are now being developed for wider acceptance of various fuel compositions. This includes operation on upgraded biogas.

Even higher electrical production efficiency can be reached by including small low pressure steam turbines to the shaft. This is being tested and supplied to some larger gas engine makes; it improves the mechanical/electrical efficiency by 2-4 percentage points.

A number of gas engine based cogeneration plants have increased their heat output and the total overall efficiency by including heat driven absorption heat pumps in the cogeneration system configuration. The outlet flue gas can be cooled to a temperature less than the available cooling water, and total efficiencies up to approx. 106% have been achieved.

For shorter start-up time services, new designs/solutions on the water side are needed to avoid sudden temperature disturbances in the heat supply.

The expected market in Denmark is limited and declining as well as the annual operation hours. This means that no significant reductions in investment and/or operation/maintenance cost are expected to be seen in the years to come.

### Uncertainty

Uncertainty stated in the tables both covers differences related to the power span covered in the actual table and differences between the various products (manufacturer, quality level, extra equipment, service contract guarantees etc.) on the market.

A span for upper and lower product values is given for the year 2020 situation. No sources are available for the 2050 situation. Hence the values have been estimated by the authors.

### Additional remarks

The information given in tables is for gas fired (n-gas and biogas) engines only. The natural gas basis is the natural gas supplied in Denmark according to regulations. The biogas basis is a methane/CO<sub>2</sub> mixture (digestion of manure and/or industrial organic waste).

## Data sheets

| Technology  | 06 Spark ignition engine, natural gas |       |       |       |                    |              |                    |              |      |           |  |
|---|---------------------------------------|-------|-------|-------|--------------------|--------------|--------------------|--------------|------|-----------|--|
|   | 2015                                  | 2020  | 2030  | 2050  | Uncertainty (2020) |              | Uncertainty (2050) |              | Note | Ref       |  |
| <b>Energy/technical data</b>  |                                       |       |       |       | <b>Lower</b>       | <b>Upper</b> | <b>Lower</b>       | <b>Upper</b> |      |           |  |
| Generating capacity for one unit (MW)   | 1-10 MWe                              |       |       |       |                    |              |                    |              |      |           |  |
| Electricity efficiency (condensation mode for extraction plants), net (%)                 | 46                                    | 47    | 48    | 50    | 40                 | 48           | 44                 | 52           | A    | 3, 4      |  |
| Electricity efficiency (condensation mode for extraction plants), net (%), annual average | 44                                    | 45    | 47    | 48    | 38                 | 46           | 42                 | 50           | A    | 3, 4, 7   |  |
| Cb coefficient (50°C/100°C)   | 0.9                                   | 0.95  | 0.99  | 1.04  | 0.65               | 1.02         | 0.65               | 1.15         |      | 3, 4, 7   |  |
| Cv coefficient (50°C/100°C)   | -                                     | -     | -     | -     | -                  | -            | -                  | -            | G    |           |  |
| Forced outage (%)   | 3                                     | 3     | 3     | 3     | 2                  | 5            | 2                  | 5            |      | 5, 6      |  |
| Planned outage (weeks per year)   | 0.8                                   | 0.8   | 0.8   | 0.8   | N.A                | N.A          | N.A                | N.A          | H    | 5, 6      |  |
| Technical lifetime (years)  | 25                                    | 25    | 25    | 25    | 25                 | >25          | 25                 | >25          | D    | 4, 5, 7   |  |
| Construction time (years)   | 1                                     | 1     | 1     | 1     | 0.5                | 1.5          | 0.5                | 1.5          | B    | 3, 6      |  |
| Space requirement (1000m <sup>2</sup> /MW)  | 0.04                                  | 0.04  | 0.035 | 0.03  | 0.03               | 0.05         | 0.025              | 0.04         |      |           |  |
| <b>Plant Dynamic Capabilities</b>   |                                       |       |       |       |                    |              |                    |              |      |           |  |
| Primary regulation (% per 30 seconds)   | 25                                    | 30    | 35    | 50    | 10                 | 40           | 25                 | 100          |      | 12        |  |
| Secondary regulation (% per minute)   | 25                                    | 30    | 40    | 50    | 20                 | 100          | 25                 | 100          | C    | 6, 12, 13 |  |
| Minimum load (% of full load)   | 50                                    | 50    | 50    | 50    | 30                 | 50           | 25                 | 50           |      | 6         |  |
| Warm start-up time (hours)  | 0.05                                  | 0.05  | 0.05  | 0.05  | 0.015              | 0.15         | 0.015              | 0.15         | C    | 6, 10     |  |
| Cold start-up time (hours)  | 0.3                                   | 0.3   | 0.3   | 0.3   | 0.2                | 0.4          | 0.2                | 0.4          | E    | 6, 10     |  |
| <b>Environment</b>  |                                       |       |       |       |                    |              |                    |              |      |           |  |
| SO <sub>2</sub> (degree of desulphuring, %)   | 0                                     | 0     | 0     | 0     | 0                  | 0            | 0                  | 0            |      | 4         |  |
| NO <sub>x</sub> (g per GJ fuel)   | 75                                    | 60    | 60    | 60    | 50                 | 100          | 50                 | 100          |      | 4         |  |
| CH <sub>4</sub> (g per GJ fuel)   | 315                                   | 315   | 280   | 250   | 300                | 400          | 250                | 350          |      | 4         |  |
| N <sub>2</sub> O (g per GJ fuel)  | 0.6                                   | 0.6   | 0.6   | 0.6   | N.A                | N.A          | N.A                | N.A          | H    |           |  |
| <b>Financial data</b>   |                                       |       |       |       |                    |              |                    |              |      |           |  |
| Nominal investment (M€/MW)  | 1                                     | 0.95  | 0.9   | 0.85  | 0.9                | 1.1          | 0.8                | 1.1          |      | 3, 5, 11  |  |
| - of which equipment  | 0.65                                  | 0.6   | 0.55  | 0.55  | N.A                | N.A          | N.A                | N.A          | H    | 3, 5      |  |
| - of which installation   | 0.35                                  | 0.35  | 0.35  | 0.3   | N.A                | N.A          | N.A                | N.A          | H    | 3, 5      |  |
| Fixed O&M (€/MW/year)   | 10,000                                | 9,750 | 9,300 | 8,500 | 7,000              | 20,000       | 6,000              | 15,000       | F    | 5         |  |
| Variable O&M (€/MWh)  | 5.4                                   | 5.4   | 5.1   | 4.9   | 4                  | 12           | 4                  | 10           | F    | 3, 5, 11  |  |



| Technology  | 06 Spark ignition engine, biogas |       |       |       |                    |              |                    |              |      |          |  |
|---|----------------------------------|-------|-------|-------|--------------------|--------------|--------------------|--------------|------|----------|--|
|   | 2015                             | 2020  | 2030  | 2050  | Uncertainty (2020) |              | Uncertainty (2050) |              | Note | Ref      |  |
| <b>Energy/technical data</b>  |                                  |       |       |       | <b>Lower</b>       | <b>Upper</b> | <b>Lower</b>       | <b>Upper</b> |      |          |  |
| Generating capacity for one unit (MW)   | 1-10 MWe                         |       |       |       |                    |              |                    |              |      |          |  |
| Electricity efficiency (condensation mode for extraction plants), net (%),                | 42                               | 43    | 45    | 47    | 38                 | 44           | 42                 | 48           | A    | 3, 4     |  |
| Electricity efficiency (condensation mode for extraction plants), net (%), annual average | 40                               | 41    | 43    | 45    | 36                 | 42           | 40                 | 46           | A    | 3, 4, 7  |  |
| Cb coefficient (50°C/100°C)   | 0.82                             | 0.86  | 0.92  | 1     | 0.59               | 0.96         | 0.75               | 1.1          |      | 3, 4, 7  |  |
| Cv coefficient (50°C/100°C)   | -                                | -     | -     | -     | -                  | -            | -                  | -            | G    |          |  |
| Forced outage (%)   | 3                                | 3     | 3     | 3     | 2                  | 5            | 2                  | 5            |      | 5, 6     |  |
| Planned outage (weeks per year)   | 1                                | 1     | 1     | 1     | N.A                | N.A          | N.A                | N.A          | H    | 5, 6     |  |
| Technical lifetime (years)  | 25                               | 25    | 25    | 25    | 25                 | >25          | 25                 | >25          | D    | 4, 5, 7  |  |
| Construction time (years)   | 1                                | 1     | 1     | 1     | 0.5                | 1.5          | 0.5                | 1.5          | B    | 3, 6     |  |
| Space requirement (1000m2/MW)   | 0.04                             | 0.04  | 0.035 | 0.03  | 0.03               | 0.05         | 0.025              | 0.05         |      |          |  |
| <b>Plant Dynamic Capabilities</b>   |                                  |       |       |       |                    |              |                    |              |      |          |  |
| Primary regulation (% per 30 seconds)   | 25                               | 30    | 40    | 50    | 10                 | 40           | 25                 | 100          | J    | 8        |  |
| Secondary regulation (% per minute)   | 25                               | 30    | 40    | 50    | 20                 | 100          | 25                 | 100          | C    | 6, 8, 13 |  |
| Minimum load (% of full load)   | 50                               | 50    | 50    | 50    | 30                 | 50           | 25                 | 50           |      | 6        |  |
| Warm start-up time (hours)  | 0.05                             | 0.05  | 0.05  | 0.05  | 0.015              | 0.15         | 0.015              | 0.15         | C    | 6, 10    |  |
| Cold start-up time (hours)  | 0.3                              | 0.3   | 0.3   | 0.3   | 0.2                | 0.4          | 0.2                | 0.4          | E    | 6, 10    |  |
| <b>Environment</b>  |                                  |       |       |       |                    |              |                    |              |      |          |  |
| SO <sub>2</sub> (degree of desulphuring, %)   | (I)                              | (I)   | (I)   | (I)   | 0                  | 99.9         | 0                  | 99.9         | K    | 8        |  |
| NO <sub>x</sub> (g per GJ fuel)   | 100                              | 100   | 100   | 100   | 90                 | 120          | 90                 | 120          |      | 4        |  |
| CH <sub>4</sub> (g per GJ fuel)   | 300                              | 300   | 300   | 300   | 300                | 400          | 300                | 400          |      | 4        |  |
| N <sub>2</sub> O (g per GJ fuel)  | 1.0                              | 1.0   | 1.0   | 1.0   | N.A                | N.A          | N.A                | N.A          | J    |          |  |
| <b>Financial data</b>   |                                  |       |       |       |                    |              |                    |              |      |          |  |
| Nominal investment (M€/MW)  | 1                                | 0.95  | 0.9   | 0.85  | 0.8                | 1.2          | 0.8                | 1.2          |      | 3, 5, 11 |  |
| - of which equipment  | 0.65                             | 0.6   | 0.55  | 0.55  | N.A                | N.A          | N.A                | N.A          |      | 3, 5     |  |
| - of which installation   | 0.35                             | 0.35  | 0.35  | 0.3   | N.A                | N.A          | N.A                | N.A          |      | 3, 5     |  |
| Fixed O&M (€/MW/year)   | 10,000                           | 9,750 | 9,300 | 8,500 | 7,000              | 20,000       | 6,000              | 15,000       | F    | 5        |  |
| Variable O&M (€/MWh)  | 8                                | 7.5   | 7     | 6     | 6                  | 13           | 4                  | 12           | F    | 3, 5, 11 |  |

### Notes:

- A Ref 1, 2 and 3 is used for 2015 values for 3 - 10 MWe engine, 1 MWe engine 4-5 % points less. Ref 4 & 5 is used for predictions for the future years.
- B The construction time given is for a medium size installation; small installations can be erected in a shorter period
- C Engines have been build and demonstrated for short start up < 1 minute for full electrical load. This includes large engines
- D Technical- and design life most often > 25 years
- E For a medium size engine; small engines with less thermal mass might be faster
- F When operating 4000 hours a year
- G Only relevant for steam based CHP
- H No data available
- I DGC estimate for years 2030, 2050
- J No known use, data from n-gas engines
- K Sulphur is removed in the biogas processing, according to manufactures spec. Lower values for biogas from waste water

### References

- [1] Cogeneration and On-site Power Production, Ltd., Penwell International.
- [2] Opportunities for Micropower and Fuel Cell/Gas Turbine Hybrid Systems in Industrial Applications, A. D. Little, US, 2000.
- [3] ASUE BHKW Kenndata 2014/2015.
- [4] DGC statistics, Efficiency and emission test reports.
- [5] DGC analysis, The gas fired cogeneration sector, Bilagsrapport 9, Energiforligningsanalyse 2013.
- [6] Features and parameters of various power plant technologies, Wartsila In Detail 02-2014 etc.
- [7] Dansk Fjernvarme and FDKV reports from CHP installations, the Dansk Fjernvarme information is from a 2012 survey for an earlier version of the report.
- [8] Ongoing Sulphur research project at DGC (MUDP).
- [9] AEA.dk
- [10] Danish Gas Technology Centre, Analysis on gas engine and gas turbine dynamics, 2013.
- [11] Blockheizkraftwerke 2013, M. Buller et al, GWF Gas Erdgas, Juni 2014.
- [12] Suppliers association information etc.
- [13] MAN Turbo Presentation of Gas Engine with fuel switch, 2012

## 07 CO<sub>2</sub> Capture and Storage

This chapter has been moved here from the previous Technology Data Catalogue for Electricity and district heating production from May 2012. Therefore, the text and data sheets do not follow the same guidelines as the remainder of the catalogue.

### Brief technology description

In fossil fired power plants the CO<sub>2</sub> content in the flue gas varies between 3 and 15 per cent of total flue gas volume, depending on the type of fuel and power plant process.

CO<sub>2</sub> capture and storage (CCS) is best suited for large point sources of CO<sub>2</sub> such as power plants. The process involves three main steps:

1. Capture of CO<sub>2</sub>.
2. Transportation to an injection sink.
3. Underground geological injection.

Several CO<sub>2</sub> capture systems are already available on a smaller scale, but generally they can be divided into three groups:

- Post-combustion capture
- Pre-combustion capture
- Oxy-fuel combustion

Illustration provided by Vattenfall ([www.vattenfall.com](http://www.vattenfall.com)).

Illustrator: [www.kjell-design.com](http://www.kjell-design.com)

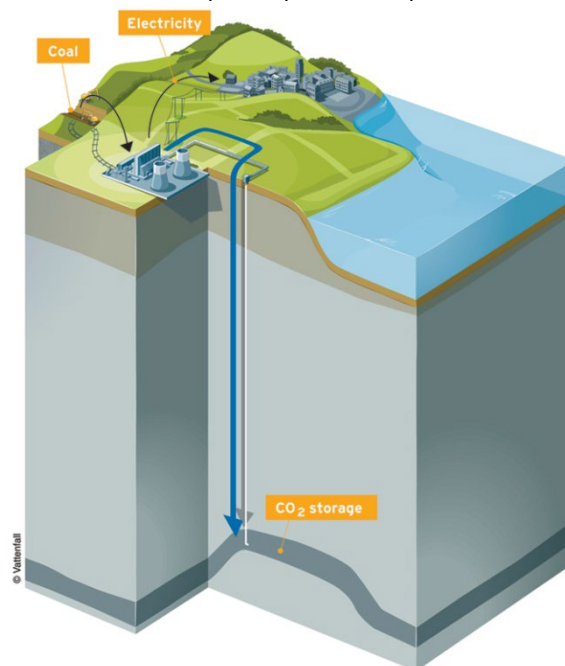

In post-combustion capture the CO<sub>2</sub> is separated from the flue gas. Several technologies have been proposed. The dominant post-combustion technology is CO<sub>2</sub> capture by absorption in chemical solvents, like aqueous amine solutions, which is a commercial technology for some industrial purposes, but not yet for power plants. After the absorption the CO<sub>2</sub> is stripped from the solvent by raising the temperature, dried, compressed and transported to the storage.

Pre-combustion capture means that the CO<sub>2</sub> is removed prior to the actual combustion process in connection to coal gasification or decarbonisation of natural gas, which essentially produce hydrogen and CO<sub>2</sub>. The hydrogen is then used as fuel. The removed CO<sub>2</sub> is compressed and transported to the storage.

In the Oxy-fuel approach the nitrogen in the air is removed prior to combustion and the fuel is combusted in an atmosphere of oxygen and recycled CO<sub>2</sub>. The flue gas will only consist of water vapour and CO<sub>2</sub>. The water vapour can easily be condensed giving a highly concentrated CO<sub>2</sub> stream, which can be compressed, purified and transported to the storage.

The major barrier for a broad use of CO<sub>2</sub> removal technology is the current high costs of separating and compressing the CO<sub>2</sub>. The extra amount of energy required for this process typically reduces the overall efficiency by around 10 percentage points.

It is necessary to transport the captured CO<sub>2</sub> from the power plant to a location where it can be injected into a suitable (permanent) storage reservoir. This is believed to be feasible primarily by using pipelines, alternatively ships, similar to LPG tankers [1].

Relevant concepts for storage are either use of CO<sub>2</sub> for enhanced oil or gas recovery or storage in deep saline formations – either offshore or onshore. CO<sub>2</sub> is also utilised in the industry for manufacture of chemical products and

in the food and drink industry, but due to the large amounts of CO<sub>2</sub> from power plants the only relevant utilisation is for enhanced oil or gas recovery [4].

### Input

CO<sub>2</sub> in flue gas.

### Output

Stored CO<sub>2</sub> and CO<sub>2</sub>-lean flue gas.

### Regulation ability

The regulation ability of a power plant is not influenced by adding post-combustion CO<sub>2</sub> capture. However, the CO<sub>2</sub> content in the flue gas decreases at part load, and thus the capture costs (in € per tonne) increases. Therefore, operating CCS power plants as base load plants may become the preferred option [4].

### Research and development

Considerable research and development work is required in order to further develop and optimise techniques that reduce barriers for a wider use, i.e. to achieve greater efficiency, confidence and monitoring of storage, mitigation strategies (if there should be a leak), and integration of technologies that require scale and lower cost.

The European Commission supports RD&D on CO<sub>2</sub> capture and storage. The 7<sup>th</sup> Framework Programme for research, technological development and demonstration activities (2007-2013) intends to support about ten demonstration plants. The key European stakeholders formed the Zero Emission Technology Platform (ZEP, [www.zeroemissionsplatform.eu](http://www.zeroemissionsplatform.eu)) in 2005.

### Examples of best available technology

Examples of best available technology for capture projects are [4]:

- The Castor pilot plant at Esbjerg Power Station that cleans a 0.5% slip stream from the power plant using post combustion technology; operated by Dong Energy. The CO<sub>2</sub> is released after capture.
- The 30 MJ/s Oxyfuel pilotplant at Schwarze Pumpe Power Plant in Germany that demonstrates the oxyfuel technology; operated by Vattenfall.

In 2007, three large-scale storage projects (over 0.5 Mt injected per year) were in operation around the world [8]:

- Offshore in Norway Statoil is injecting CO<sub>2</sub> from the Sleipner oil field in the Utsira aquifer. The field has a special feature as the gas has a CO<sub>2</sub> content of around 9%, which must be reduced to 2.5% before it is sold. The CO<sub>2</sub> that is stripped from the gas is injected into a structure 800 metres below the seabed is around one million tonnes of CO<sub>2</sub> per year. Injection began in 1996. The injection and storage is intensively monitored and provides data to various projects.
- CO<sub>2</sub> is extracted from natural gas from the In Salah gas field in Algeria. The CO<sub>2</sub> is injected into a carboniferous reservoir containing water, underlying the gas producing zone.
- CO<sub>2</sub> is extracted from natural gas from the Snohvit gas field in the Barents Sea, Norway. The CO<sub>2</sub> is injected 2600 metres underneath the gas producing zone.

### Additional remarks

The costs of CCS are often divided according to the three main steps of the process:

1. Capture of CO<sub>2</sub>, including compression for transport.
2. Transportation to an injection sink.
3. Underground geological storage.

The bulk of the costs of CCS projects are associated with CO<sub>2</sub> capture. For the most cost effective technologies, total capture costs (capital plus O&M costs) are USD 25 to 50 per tonne of CO<sub>2</sub> emissions avoided, with transport and storage about USD 10 per tonne [8]. For typical European offshore settings the transport and storage cost is higher than this, and the variation from project to project is substantial [12].

Carbon capture technologies at the scale needed for power plants have not yet been demonstrated. Hence, most reported cost figures are only estimates, based on scaling up of smaller components used in other industries or on manufacturers' expert judgement based on experience from other (near-) proven technologies. The accuracy of the resulting estimates usually lies within the range of ±30 % [13].

CO<sub>2</sub> capture and compression consumes energy, which may result in additional emissions that must be taken into account when evaluating the impact and the cost-efficiency of CCS. The terms CO<sub>2</sub> capture cost and CO<sub>2</sub> avoidance cost are used for these two different evaluation methods.

Capture cost: Cost of capturing one tonne of CO<sub>2</sub>.

Avoidance cost: Cost of reducing the CO<sub>2</sub> emission by one tonne, assuming same electricity generation.

For power plants, capture cost can be translated into avoidance cost based on the equation:

$$Cost(avoided) = \frac{Cost(captured) \cdot CE}{\frac{\eta_{new}}{\eta_{old}} - 1 + CE}$$

Where  $\eta_{new}$  and  $\eta_{old}$  are the electricity efficiencies of the power plants with and without CO<sub>2</sub> capture, and CE is the fraction that is captured. For example, if  $\eta_{new}$  and  $\eta_{old}$  are 35% and 43% and CE is 0.90, the cost ratio (avoided/captured) is 1.26.

Expressing CCS costs in terms of the cost per tonne of CO<sub>2</sub> avoided allows those costs to be directly compared with other CO<sub>2</sub> abatement measures in terms of the cost of the environmental effects that have been achieved.

As most coal-fired power plants have a long lifespan, any rapid expansion of CCS into the power sector would include retrofitting. The costs of retrofitting depend much on local circumstances:

- A case study from Norway has suggested that a retrofit would reduce efficiency by 3.3% more than a new integrated system [8]. The average cost of CO<sub>2</sub> avoided for retrofits is about 35 % higher than for new plants. Several factors significantly affect the economics of retrofits, especially the age, smaller sizes and lower efficiencies typical of existing plants relative to new builds. The energy requirement for CO<sub>2</sub> capture also is usually higher because of less efficient heat integration for sorbent regeneration [10].
- A case study from Denmark indicates that retrofitting results in very little additional costs and that the electricity efficiency is only marginally lower compared with new projects [4].

There are two main methods of CO<sub>2</sub> transportation [14]:

- Pipeline costs are roughly proportional to distance.
- Shipping costs are fairly stable over distance, but have 'step-in' costs, including a stand-alone liquefaction unit potentially remote from the power plant. The cost is less dependent on distance.

For short to medium distances and large volumes, pipelines are therefore by far the most cost-effective solution.

Pipeline costs may increase in congested and heavily populated areas by 50 to 100 % compared to a pipeline in remote areas, or when crossing mountains, natural reserves, rivers, roads, etc.; and offshore pipelines are 40 – 70 % more expensive than similar pipelines built on land [10].

## References

1. Putting Carbon Back in the Ground, IEA Greenhouse Gas R&D Program, February 2001

2. CO<sub>2</sub> Capture and Storage in Geological Formations, by Jacek Podkanski, IEA 2003
3. CO<sub>2</sub> Capture at Power Stations and Other Major Point Sources, Jacek Podkanski, IEA 2003
4. Vattenfall, 2010.
5. Uncertainties in Relation to CO<sub>2</sub> Capture and Sequestration. Preliminary Results, Dolf Gielen, IEA/EET Working Paper 2003
6. The Future Role of CO<sub>2</sub> - Capture and Storage Results of the IEA-ETP Model, Dolf Gielen, 2003
7. [www.ieagreen.org.uk](http://www.ieagreen.org.uk)
8. "Energy technology perspectives 2008", International Energy Agency, 2008.
9. "CO<sub>2</sub> Capture and Storage. A key carbon abatement option", the International Energy Agency, 2008.
10. "Carbon Dioxide Capture and Storage", International Panel on Climate Change (IPCC), 2005.
11. "Carbon Sequestration Leadership Forum Technology Roadmap" (CSLF; [www.cslforum.org](http://www.cslforum.org)), 2009.
12. DONG Energy, 2009.
13. "The Cost of Carbon Capture and Storage Demonstration Projects in Europe", JRC Scientific and Technical Reports, European Commission, 2009.
14. "The Costs of CO<sub>2</sub> Capture, Transport and Storage", Zero Emissions Platform (ZEP), July 2011.

### Data sheets

JRC [13] made a thorough review and analysis of most recent (in 2009) cost assessments of CCS. As a unique feature, all assumptions are presented in the report. All data on this page are from this report.

The mentioned reference values are calculated by a weighted average of data from 13 reviewed reports, the weighting factors determined by the robustness of the reported figures.

The following capture technologies are included:

IGCC-CCS: Integrated Gacification (of coal) Combined Cycle with pre-combustion capture

PF-CCS: Pulverized Fuel (coal) with post-combustion capture

NGCC-CCS: Natural Gas Combined Cycle with post-combustion capture

Oxyfuel: Oxyfuel combustion with post-combustion capture

|                        |   | IGCC-CCS | PF-CCS | Oxyfuel | NGCC-CCS |
|------------------------|---|----------|--------|---------|----------|
| Electricity efficiency |   |          |        |         |          |
| Low                    | % | 32       | 29     | 35      | 45       |
| High                   | % | 35       | 43     | 41      | 47       |
| Reference value        | % | 35       | 35     | 35      | 46       |

All plants have a net capacity of 400 MW, and all costs are in Euro 2008:

|                          |           | Carbon capture            |        |         |          |
|--------------------------|-----------|---------------------------|--------|---------|----------|
|                          |           | IGCC-CCS                  | PF-CCS | Oxyfuel | NGCC-CCS |
| Specific investment cost |           |                           |        |         |          |
| Low                      | M€/MW     | 1.835                     | 1.641  | 2.122   | 0.937    |
| High                     | M€/MW     | 3.241                     | 3.710  | 4.279   | 1.766    |
| Reference cost           | M€/MW     | 2.7                       | 2.5    | 2.9     | 1.3      |
| Fixed O&M cost           |           |                           |        |         |          |
| Low                      | €/MW/year | 60000                     | 42000  | 44000   | 27000    |
| High                     | €/MW/year | 86000                     | 80000  | 104000  | 56000    |
| Reference cost           | €/MW/year | 75000                     | 65000  | 90000   | 38000    |
| Variable O&M cost        |           |                           |        |         |          |
| Low                      | €/MWh     | 1.6                       | 3.7    | 0.1     | 0.6      |
| High                     | €/MWh     | 2.9                       | 5.8    | 3.6     | 1.2      |
| Reference cost           | €/MWh     | 2.1                       | 4.5    | 0.9     | 0.9      |
|                          |           | CO2 transport and storage |        |         |          |
| Low                      | €/tonne   | 5                         |        |         |          |
| High                     | €/tonne   | 40                        |        |         |          |
| Reference cost           | €/tonne   | 20                        |        |         |          |

JRC calculated the costs of CCS plants including pipelines and storage compared to reference state-of-the-art conventional plants that use the same fuel and are of the same net electricity output. The average costs per tonne of CO<sub>2</sub> avoided for the coal-fired CCS plants and the NGCC-CCS plant were 87 €/t and 118 €/t respectively.

The below table, in the same format as other technologies in this report, has been developed using other sources than the above-referenced JRC-report.

| Technology                                | CO2 capture (post-combustion), pulverized coal power plant |                 |                 |                 |      |                   |         |
|---|--|-----------------|-----------------|-----------------|------|-------------------|---------|
|   | 2010   | 2020            | 2030            | 2050            | Note | Ref               |         |
| <b>Energy/technical data</b>              |  |                 |                 |                 |      |                   |         |
| Generating capacity for one unit (MW)     | 500 - 740  |                 |                 |                 |      |                   | 1+2+3+4 |
| Capture efficiency (%)                    | 90   | 90              | 90              | 90              | A    | 1                 |         |
| Generation efficiency decrease (%-points) | 8-10%  | 8-10%           | 8-10%           | 8-10%           | B    | 1+2+3             |         |
| <b>Financial data</b>                     |  |                 |                 |                 |      |                   |         |
| <b>Capture, post-combustion</b>           |  |                 |                 |                 |      |                   |         |
| Nominal investment (M€/MW)                | 2.3-4.3  | 3.07            | 3.00            | 2.86            | C    | 1+2+3+4;<br>2;2;2 |         |
| Fixed O&M (€/MW/year)                     | 72000-<br>87000  | 72000-<br>87000 | 72000-<br>87000 | 72000-<br>87000 | D    | 1+2               |         |
| Variable O&M (€/MWh)                      | 3.4-4.1  | 3.4-4.1         | 3.4-4.1         | 3.4-4.1         | D    | 1+2               |         |

**References:**

- 1 "The Costs of CO2 Capture, Transport and Storage", Zero Emissions Platform (ZEP), July 2011
- 2 "UK Electricity Generation Costs Update", Mott MacDonald, June 2010.
- 3 "Energy Technology Perspectives", IEA 2010
- 4 "Project Costs of generating Electricity", IEA & NEA, 2010

**Notes:**

- A The non-captured CO2 is released into the atmosphere.
- B Some of the electricity consumption may be regained as useful heat. The displayed efficiency decreases do most probably take the usage of heat into account.
- C The nominal investment is per net generating capacity, i.e. after deducting the power consumed for CO2 capture. If you compare two power plants, with CCS (this element) and without CCS (element 01), and with the same net power generating capacity, the difference in nominal investment (e.g. 3.07-2.03 = 1.04 M€/MW in 2020) is the value of the capture equipment. If CO2 capture is added on to an existing power plant, the loss in generating capacity shall be taken into account.
- D The O&M costs are per net generating capacity and net generation, i.e. after deducting the power consumer for CO2 capture.

The ZEP report [14] is probably the most complete analysis of CO<sub>2</sub> transport costs to date. The report describes three methods of transportation and for each of these present detailed cost elements and key cost drivers. The three methods are:

- Onshore pipeline transport
- Offshore pipeline transport
- Ship transport, including utilities.

The following table shows the unit transportation cost (EUR/tonne) for such projects, depending on transport method and distance, and with typical capacities in million tonnes per annum (Mtpa):



| Typical capacity of 2.5 Mtpa, 'point-to-point' connections |         |      |      |      |      |
|--|---------|------|------|------|------|
| Distance   | km      | 180  | 500  | 750  | 1500 |
| Onshore pipe   | €/tonne | 5.4  | n.a. | n.a. | n.a. |
| Offshore pipe  | €/tonne | 9.3  | 20.4 | 28.7 | 51.7 |
| Ship   | €/tonne | 8.2  | 9.5  | 10.6 | 14.5 |
| Liquafaction (for ship transport)                          | €/tonne | 5.3  | 5.3  | 5.3  | 5.3  |
| Typical capacity of 20 Mtpa, 'point-to-point' connections  |         |      |      |      |      |
| Distance   | km      | 180  | 500  | 750  | 1500 |
| Onshore pipe   | €/tonne | 1.5  | 3.7  | 5.3  | n.a. |
| Offshore pipe  | €/tonne | 3.4  | 6.0  | 8.2  | 16.3 |
| Ship (including liquefaction)                              | €/tonne | 11.1 | 12.2 | 13.2 | 16.1 |

The ZEP report [14] also provides an update on storage costs:

| Case     |                             |               | Cost range (€/tonne CO2 stored) |        |      |
|----------|-----------------------------|---------------|---------------------------------|--------|------|
|          |                             |               | Low                             | Medium | High |
| Onshore  | Depleted oil and gas fields | Existing well | 1                               | 3      | 7    |
| Onshore  | Depleted oil and gas fields | New well      | 1                               | 4      | 10   |
| Onshore  | Saline aquifer              | New well      | 2                               | 5      | 12   |
| Offshore | Depleted oil and gas fields | Existing well | 2                               | 6      | 9    |
| Offshore | Depleted oil and gas fields | New well      | 3                               | 10     | 14   |
| Offshore | Saline aquifer              | New well      | 6                               | 14     | 20   |

## Introduction to Waste and Biomass plants

Due to large similarities the qualitative description of biomass and waste fired plants are presented with a common technology description. Also, the chapters describing combined heat and power (CHP) and heat only plants (HOP) for biomass and waste respectively have been merged in an effort to make the catalogue easier to read.

### Contact information

Danish Energy Agency: Jacob Hjerrild Zeuthen/Filip Gamborg

Author: Rambøll: Claus Hindsgaul, Tore Hulgaard

Reviewer: Niels Houbak

### Publication date

March 2018

### Amendments after publication date

---

| Date                  | Ref.                                     | Description  |
|-----------------------|--|--|
| <b>March 2020</b>     | 09 Biomass section                       | Medium and Large scale wood chips boilers added.<br>Text revised to incorporate new larger boilers.<br>Revision of ash-content and lower heating value for wood chips. |
| <b>January 2020</b>   | Introduction, biomass and waste sections | Text revised. PQ-diagrams for backpressure and extraction units added.   |
| <b>September 2018</b> | Introduction, biomass and waste sections | Version 3: Updated introduction to waste and biomass and merging of CHP and HOP descriptions for waste and biomass respectively.                                       |

## Qualitative description

### Brief technology description

The description includes technologies that have large similarities when used for CHP and HOP fired with biomass or waste, the latter named Waste-to-Energy (WtE) facility. The main systems are presented in Figure 9, illustrated by a WtE CHP facility.

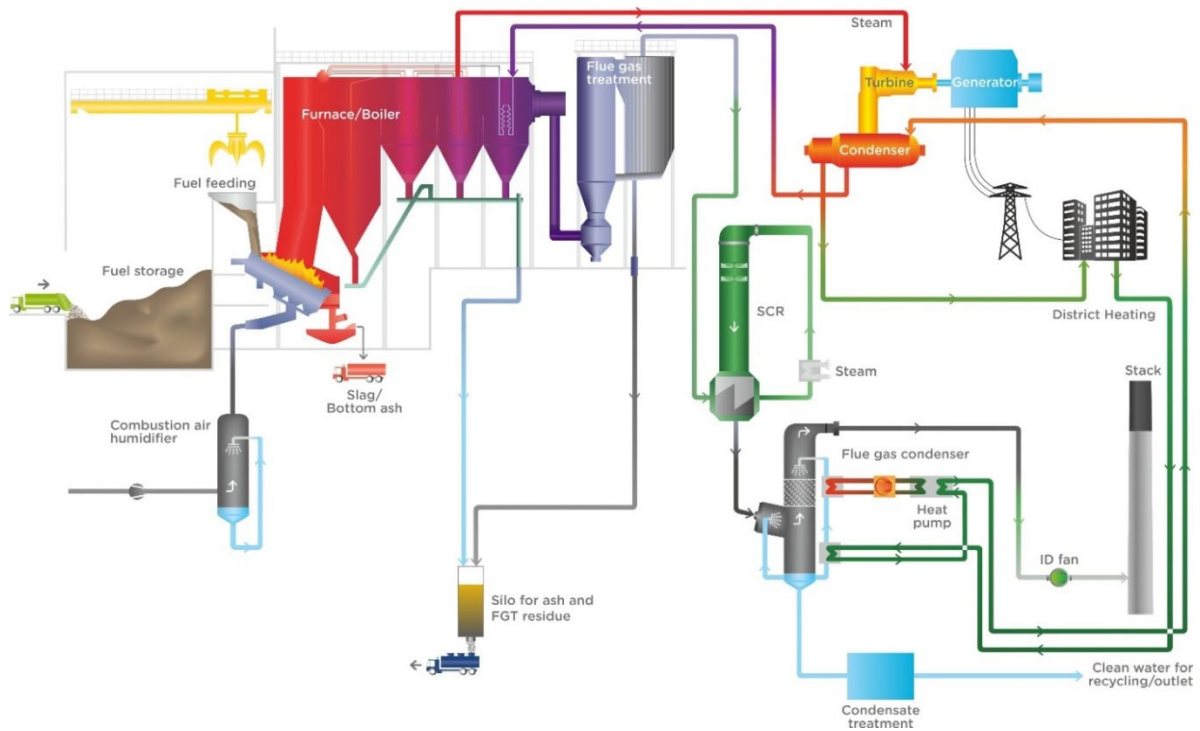

Figure 1 Main systems of a CHP (or Heat only) facility, example WtE CHP facility

The main systems of a biomass or waste fired CHP plant are:

- Fuel reception and storage area,
- Furnace or firing system including fuel feeding
- Steam boiler
- Steam turbine and generator,
- Flue gas treatment (FGT) system potentially including an SCR-system for NO<sub>x</sub> reduction
- Systems for handling of combustion and flue gas treatment residues
- Optional flue gas condensation system
- Optional combustion air humidification system

In case of HOP, the steam boiler is replaced with a hot water boiler, and no turbine/generator set is included. Other main systems are in principle the same as for the CHP-plants. New Danish plants with a heat capacity >1 MW are currently required to be designed as CHP [6]. This requirement for combined heat and power production is debated and changes in legislation must be checked up on.

### Input

Wood chips, wood pellets and straw are considered for biomass plants. Other types of biomass e.g. other forest residues; sawdust and nut shells may be relevant as energy source, while different fuels set different technical requirements for the plant, these differences will not be addressed.

Waste to energy (WtE) facilities receive non-recyclable municipal solid waste (MSW), commercial waste and certain fractions of industrial waste and construction & demolition waste. It may also include refuse derived fuel (RDF), for instance imported from the United Kingdom. Certain types of hazardous waste may be included but dedicated hazardous waste plants are not covered here. More on fuel follows in the respective chapters on WtE and biomass.

### Fuel reception and storage

The fuel is received by ship or lorry. Storage is usually available on site for a minimum of two days full load operation. For wood chips and wood pellets the fuel storage will typically have a capacity of 1-2 weeks. Straw is received in bales and stored in an enclosed building in order to avoid exposure to moisture; wood pellets are stored in a closed silo; wood chips may be stored outside, but often under roof to limit exposure to rain. The investment costs in the datasheets for biomass include two days’ storage, only. In many cases the optimal fuel storage capacity would be larger. Therefore, specific cost of fuel storage per day in excess of 2 days is listed separately in the datasheet.

Waste is received and stored in a closed building to avoid escape of odour and it is unloaded into a dedicated bunker from where a grab brings it to the feeding hopper. The bunker would usually be sized for 4 days of operation.

### Furnace

The furnace is where the fuel is injected, dried, pyrolyzed and burnt and the energy content is converted to hot flue gas for subsequent uptake in the boiler. The typical furnace technologies can be divided into: grate firing, different types of fluidised beds (FB) and suspension firing, where the fuel is pulverized or chopped and blown into the furnace, optionally in combination with a fossil fuel.

Grate combustion is a well-established and robust technology with regard to using different types of biomass. It can be further divided into a number of subcategories, e.g. according to EN ISO 17225-1 Solid biofuels – Fuel specifications and Classes – Part 1: General requirements. There are examples of combined boiler technologies with both suspension- and grate firing. For geometrical reasons there is a limit to how big a grate fired plant can be constructed – of the order slightly below 200 MW thermal input.

Only a few biomass FB boilers exist in Denmark. Large FB boilers are of the type Circulating Fluid Bed (CFB) and they are typically used for CHP plants in situations where the plant size exceeds the maximum for grate firing. In particular, wood chips is an excellent fuel for FB boilers.

Alternatively, suspension firing is suitable for very large biomass power plants (substantially above 200 MW thermal input) and it requires a pulverisation of the fuel before it is fed into the furnace. Pulverisation of biomass is not an easy task but in particular pellets can be disintegrated into its finer particles using a (coal) mill. These particles are often adequate directly for combustion. Dust firing from milled wood pellets is widely used in e.g. Sweden for smaller plant down to approx. 50 MW thermal input.

WtE facilities in Denmark are all grate fired. At WtE plants an afterburning chamber ensures that temperature and residence time requirements are met. During boiler start-up biomass or auxiliary burners in the furnace fired by oil or gas are needed to ensure heating to the required temperature. During normal operation, no auxiliary fuel is added.

Typical sizes of furnace types are shown in the following table.

| Boiler input | MW                   | 1 | 2 | 5 | 10 | 20 | 50 | 100 | 200 | 500 | 1000 |
|--------------|----------------------|---|---|---|----|----|----|-----|-----|-----|------|
| FB           | BFB                  |   |   |   |    |    |    |     |     |     |      |
|              | CFB                  |   |   |   |    |    |    |     |     |     |      |
| Grate        | Traveling grate      |   |   |   |    |    |    |     |     |     |      |
|              | Reciprocating grates |   |   |   |    |    |    |     |     |     |      |
|              | Vibrating Grate      |   |   |   |    |    |    |     |     |     |      |
| Dust fired   |                      |   |   |   |    |    |    |     |     |     |      |

Table 1 Typical sizes of furnace technologies, BFB refers to bubbling fluidized bed, CFB to circulation fluidized bed and grate furnace have been further divided in three subcategories.

## Boiler

The boiler is where the energy content of the flue gas is transferred by heat exchange to the heat media, which is usually hot water and in case of CHP, water and steam. As flue gas passes through the boiler, it is cooled, and the heat media is heated by heat exchange. In a heat only boiler, water is heated to supply the necessary district heating (DH) supply temperature, which is typically up to 90°C in Denmark for distribution networks and somewhat higher when the DH water is led to the transmission networks.

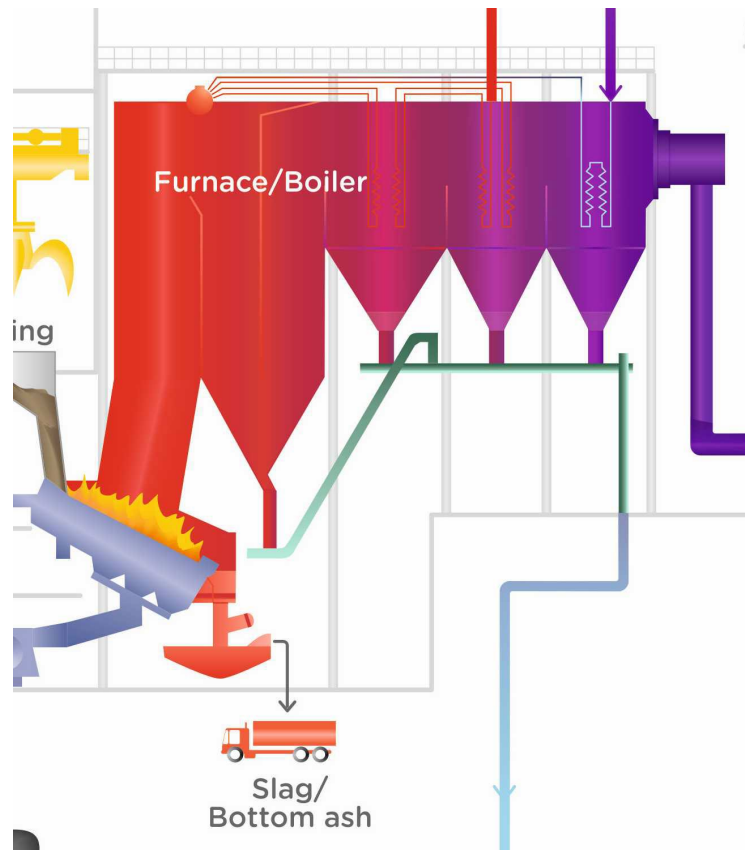

Figure 2 Furnace/boiler system

The output from the boiler of a CHP facility is superheated steam, i.e. steam that is heated above the boiling point. The plant includes feed water pumps supplying high pressure water to the boiler, an economiser, where the input water is heated towards the boiling temperature, evaporators, where the water is evaporated to steam, a drum vessel for separation of steam and water, and super heaters, where the steam is heated above the boiling temperature. Large biomass facilities may use different boiler types.

## Turbine/generator

The turbine/generator set is only included in CHP (or power only) facilities. The superheated high-pressure steam from the boiler is led to the turbine where the energy content of the steam is converted to rotation energy in the turbine. Through its connection to the generator, the rotation energy is converted to electricity.

The temperature and pressure of the steam decrease as the steam drives the rotation of the turbine blades. The low-pressure steam is extracted from the turbine to DH condensers at the pressure and temperature levels that suit the requirements of the DH network. The condensation heat is delivered to the DH network. This is different from a power-only facility where condensation happens at lower temperatures and the heat of condensation is wasted, e.g. in an air-cooled condenser. The power efficiency of a CHP facility is therefore lower than the corresponding power-only facility,

but the total efficiency is much higher. Power-only facilities are not included in the present technology sheets. The turbine- and generator system of a backpressure CHP is shown in Figure 3.

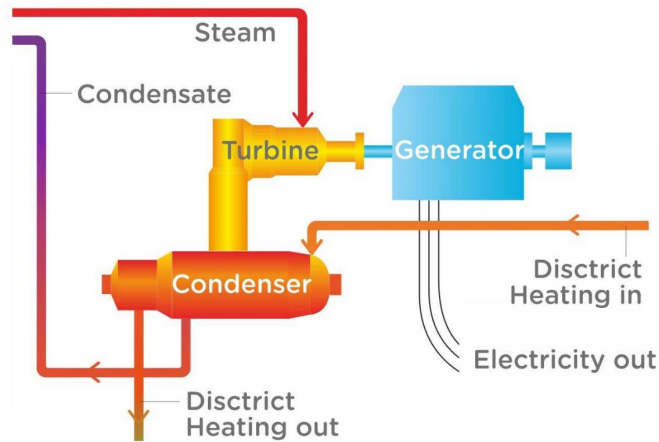

Figure 3 Turbine/generator system of backpressure CHP

A steam extraction turbine is more complex and has two heat exchangers. One of them is connected to the DH network, similar to the case for the backpressure CHP, while the other exchanges heat to the surroundings (usually large water reservoirs are used in DK, e.g. sea water). The steam can be cooled in one of the heat exchangers (condensing- or backpressure mode) or in a combination of both (extraction mode).

Heat- and power diagrams (PQ-diagrams)

The heat- and power diagrams (PQ-diagram) for backpressure- and extraction CHPs differs due to their different turbine setups. They both share the option to co-produce electricity and heat to the DH network in backpressure pressure mode. In backpressure mode the ratio of electricity divided by heat and electricity is specified by the backpressure coefficient (cb).

The PQ-diagram for a generic backpressure CHP with the ability to by-pass the turbine is shown in Figure 4.

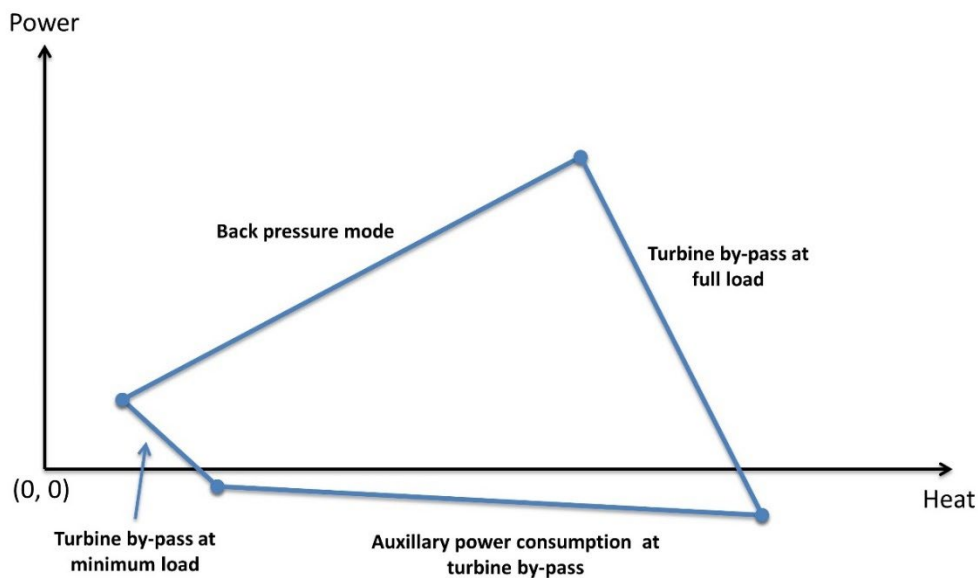

Figure 4 Generic PQ-diagram for backpressure CHP

The backpressure CHP can by-pass the turbine and produce heat only. As indicated in the figure, the net electricity output can also be negative when the turbine is completely disengaged. The electricity consumption at this point is given by the auxiliary power consumption.

The PQ-diagram for an extraction CHP is shown in Figure 5.

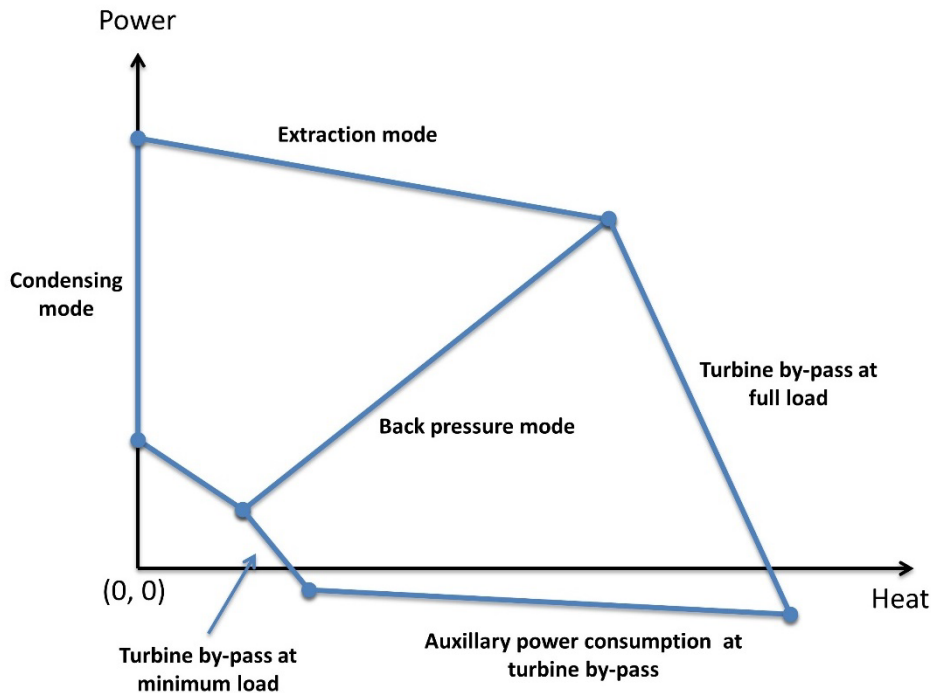

Figure 5 Generic PQ-diagram for extraction CHP

The extraction unit is capable of operating both in backpressure and condensing mode as well as every combination in between. This enables a large degree of freedom in varying the electricity and heat generation. From the point of full production in condensing mode to full production in backpressure mode, the loss of electricity generation per unit of heat generated at fixed fuel input is given by the extraction coefficient ( $C_v$ ).

See [Annex 1](#) for more information about steam extraction turbines.

### Flue gas treatment (FGT)

The flue gas is treated to meet the emission requirements of biomass and waste, respectively. The FGT always includes a particle filter, either an electrostatic precipitator (ESP) or a bag house filter (BHF). Acid gases (HCl,  $SO_2$  and HF) are mitigated in a dry or semi-dry process by injection of hydrated lime, for subsequent capture in a BHF, or in a wet scrubbing system. Using a wet scrubbing system reduces the amount of solid residue compared with the dry process, but effluent water must be treated before discharge to meet stringent emission levels. In WtE dioxin and mercury may be captured by injection of activated carbon.

$NO_x$  is mitigated by the SNCR or SCR process (SNCR and SCR are Selective Reduction of  $NO_x$  by ammonia injection, by the respective Non-Catalytic or Catalytic process). The SNCR process works by injection of ammonia in the furnace at around  $900^\circ C$ . It has limited efficiency, and to meet stringent emission limit values it may be necessary to install the highly efficient catalytic SCR system. With biomass and waste an SCR system would usually be located downstream of the main FGT (tail-end) or at least downstream the particle filter to avoid that certain elements in the flue gas deactivate the catalyst.

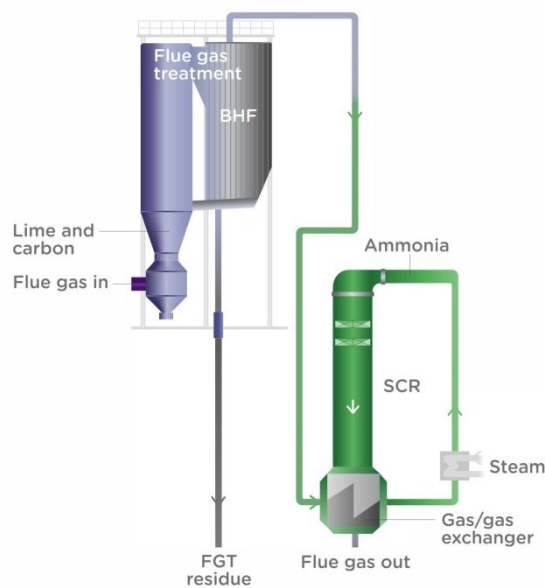

Figure 6 Flue gas treatment system (dry/semi-dry) including reactor with injection of hydrated lime, a bag house filter and an SCR system with gas/gas heat exchanger, steam reheater, ammonia injection and catalyst.

### Handling of solid residues

Solid residues include incombustible matter (ash) and flue gas treatment (FGT) residues. With biomass most of the ash is segregated in the boiler or particle filter and collected in a silo for disposal together with the FGT residue. In case of WtE the ash makes up 15-20% of input waste, and around 90% thereof leaves the facility as bottom ash, segregated from the furnace grate.

### Flue gas condensation system

The flue gas condensation system is installed for increased heat recovery primarily through condensation of the water vapours of the flue gas. The energy efficiency could thereby be increased by more than 20%-point. Flue gas condensation is currently customary in WtE facilities and biomass fired facilities, particularly when using wood chips, waste, and similar relatively wet fuels.

Flue gas condensation may be arranged as a wet scrubbing system (Figure 13) in which the scrubbing liquid is cooled by heat exchange with DH water. The relatively cold DH water cools the scrubber and it is thereby heated. When the cooled scrubbing liquid meets the warmer flue gas that has been saturated with water vapour, the vapour condenses, thereby releasing the heat of condensation. The condenser may also be arranged with flue gas running in vertical tubes exchanging heat with DH water surrounding the tubes or plate heat exchangers in the flue gas path. The flue gas condensation system may be divided into two systems. First stage is direct condensation where heat recovery happens by direct heat exchange with DH water and in the second stage condensation is assisted by heat pumps. The heat recovery by direct condensation is limited by the DH return temperature. The lower the temperature, the higher the heat recovery. The heat pump allows cooling the flue gas and condensation of water vapour to quite low temperature (20-30°C), corresponding to very high energy recovery at the expense of driving energy for the heat pump (typically steam or electricity).



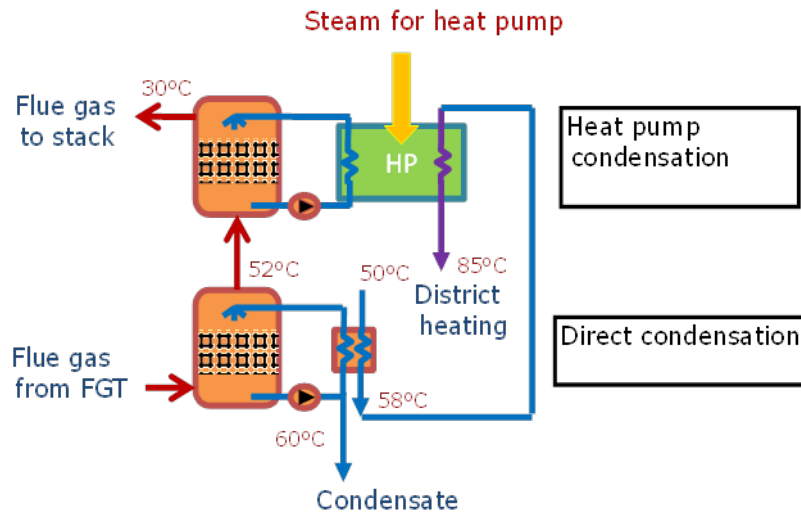

Figure 7 Flue gas condensation, direct and heat pump driven with 50°C DH return temperature, and typical WtE adiabatic scrubber temperature of 60°C.

In the datasheets, only direct condensation is included to the level limited by the DH return temperature of 40°C or 50°C, depending on the case. The heat pump condensation potential is listed separately (“Additional heat potential for heat pump (%)”), and not included in the listed efficiencies. Section *Total energy efficiency determination with flue gas condensation* below describes how to quantify the total efficiency for a biomass or WtE facility with flue gas condensation given a specific fuel and DH temperature.

Running the flue gas through several wet scrubbers of the flue gas condensation system contributes to reaching very low emissions of HCl, SO<sub>2</sub>, dust, heavy metals and ammonia.

### Condensate and wastewater treatment

Process waste water from a wet scrubber (if included) must be treated prior to discharge to the sewage system or the sea. In any case, stringent requirements apply, governed for instance by [7]. Treatment includes neutralisation, precipitation of heavy metal ions and filtering, and generation of a small amount of sludge.

Condensate from flue gas condensation has low content of salts and pollutants when the condensation system is located downstream the FGT-system. Condensate treatment includes reverse osmosis to yield very clean water useful for industrial applications including boiler make-up water and make-up water for the DH network. The net water production may significantly exceed the original fuel moisture content, due to water formed from hydrogen and oxygen during combustion. For relatively wet fuels the excess water may be more than 500 kg per tonne of fuel input.

The excess condensate is clean, virtually salt-free water and may be used for internal purposes such as boiler make-up water, for FGT and cooling of bottom ash, effectively replacing external water supply. It may also be considered a recovered resource to be used externally for covering water losses in the district-heating network and for industrial purposes. If this is not possible, excess cleaned condensate may be discharged to the sea or the local sewage system (at a cost). The amount of excess recovered condensate is listed in the tables and included in the variable operating cost, cf. financial section. Only internal consumption for make-up water supply of steam systems is subtracted in the listed values.

### Combustion air humidification system

Combustion air humidification may to some extent substitute the use of heat pump driven condensation for increased heat production. Combustion air humidification works by adding water vapour to the combustion air, thereby increasing the content of water vapour in the flue gas as it enters the flue gas condensation system, in turn increasing the heat output of the direct flue gas condensation. The energy needed to generate the water vapour input to the combustion

air is recovered from the last stage of the flue gas condensation system, at the temperature level below the DH temperature. This low temperature heat, at e.g. 40°C, is used as heat source for evaporation of water in the combustion air humidification system.

The high-level effect of combustion air humidification is that the flue gas is cooled further than it is possible by heat exchange with the DH water, thereby representing an increase in energy recovery from the fuel. In the data tables it is assumed that combustion air humidification (if included) reduces the flue gas condensation temperature by 5°C and 8°C at DH return temperatures 40°C and 50°C, respectively. Currently no WtE facilities in Denmark are equipped with air humidification, but the system is customary in biomass fired facilities having flue gas condensation.



Figure 8 Combustion air humidifier, where water heated by a low-temperature source is evaporated into the combustion air flow.

### The energy model for the technology datasheets

A new approach has been introduced to generate the data tables for the biomass and waste combined heat and power (CHP) and heat only plants in this version of the datasheets. Due to the technological similarities, a common model has been used to populate the sheets for biomass and waste. This ensures a better consistency of the data spanning many scenarios and feedstocks. It is believed that this will eliminate skewness caused by interpretation of reference data and differences in conditions for the reference plants, such as fuel and DH infrastructures.

The energy efficiency estimates in the datasheets were calculated using a thermodynamic model of flue gas energy recovery to steam and DH, including flue gas condensation [4]. A steam cycle model estimated the steam-to-power efficiency based on the steam parameters and turbine sizes. The same models were used to estimate efficiencies for the datasheets covering heat only and CHP plants for WtE as well as biomass plant types at all size ranges. The different performances are thus a consequence of different plant design data assumed in each case and the fuel properties.

Table 1 shows the basis plant design assumptions made for the “2015” scenarios for different feedstocks. Conservative and optimistic variations of these assumptions were made to produce the future, “Upper” and “Lower” performance data. For example, the electricity efficiency in “Lower” WtE would assume steam at 400°C/40bar and no combustion air humidification, while “Upper 2050” assume 500°C/90bar, which will require advances in the technology. For small-to-medium biomass plants, “Upper” electricity efficiency assumes the relatively low excess air level offered by the Dall boiler already today etc.

| Fuel | Waste | Wood chips | Wood pellets | Straw |
|------|-------|------------|--------------|-------|
|------|-------|------------|--------------|-------|

|  |              |                       |              |              |
|--|--------------|-----------------------|--------------|--------------|
| <b>Firing system</b>   | Grate        | Grate/<br>CFB (large) | Suspension   | Grate        |
| <b>Live steam, CHP</b>   | 425°C/50 bar | 540°C/90 bar          | 560°C/90 bar | 540°C/90 bar |
| <b>Flue gas temperature after steam boiler</b>                     | 160°C        | 130°C                 | 130°C        | 130°C        |
| <b>Excess air ratio</b>  | 1,5          | 1,3                   | 1,3          | 1,3          |
| <b>Boiler losses other than flue gas<br/>(% of LHV)</b>            | 2%           | 2%                    | 2%           | 2%           |
| <b>Turbine losses (gear/generator)<br/>(% of gross power), CHP</b> | 3%           | 3%                    | 3%           | 3%           |
| <b>Flue gas condensation</b>                                       | Yes          | Yes                   | Yes          | Yes          |
| <b>Combustion air humidification</b>                               | No           | Yes                   | Yes          | Yes          |
| <b>Flue gas cleaning type</b>                                      | Wet          | Dry                   | Dry          | Dry          |
| <b>NOx abatement<br/>(small and medium size)</b>                   | SNCR         | SNCR                  | SNCR         | SNCR         |
| <b>NOx abatement<br/>(large facilities)</b>                        | SNCR         | SNCR                  | SCR          | SCR          |

Table 2 Base assumptions for “2015” model CHP plants for energy performance estimation.

The total efficiency of plants with flue gas condensation is calculated assuming “direct condensation”, where the condensation heat is recovered directly with the available DH water without the use of heat pumps.

DH plants share base assumptions with the CHP plants, except that live steam parameters are not applicable, and the losses associated with a steam system and turbine/generator do not exist for these plants.

At some plants, condensation heat recovery is augmented by cooling the flue gas further, typically to 30°C using heat pumps. In the datasheets, the row “Additional heat potential for heat pump (%)” contains the additional heat that a heat pump would recover from the flue gas by cooling it further to 30°C. The so produced additional heat is the sum of this recovered amount of heat and any external driving energy (electricity or steam) supplied to drive the heat pump. The efficiencies listed in the data tables do not include the contribution from heat pump driven condensation, and the heat pump investments are not included in the listed investments.

As an example, the plant Amager Bakke would belong to the “Large WtE” plants with high DH temperature levels of 50/100°C. The 2015 data from the datasheets provide name plate values of 21.3% for power and 75.3% for heat, summing up to 96.6%. The additional heat from heat pumps is given as 10.0%, increasing the sum to 106.6%.

Without heat pumps, the actual design power efficiency of 25% at Amager Bakke is higher than the 21.3% that the tables suggest. This is mainly due to the high steam parameters (440°C/70bar), and the lower forward temperature of the actual DH water (85°C instead of the 100°C assumed in the tables). The total design efficiency is 95% without using heat pumps, which is on level with the 96.6% from the tables.

With heat pumps activated, the total efficiency at Amager Bakke reaches 107%. This is slightly higher than the 105.5 % in the tables, which is due to the flue gas being cooled to 20 °C instead of 30 °C, and some additional component cooling heat recovery is performed by the installed heat pumps as well. The power efficiency is reduced to 22.5% when using

the heat pumps, mainly due to the transfer of driving steam for the heat pumps. The system coefficient of performance (COP) of the heat pump system is estimated at around 5.5, meaning that 5.5 MWh of heat is generated for one MWh reduction of electricity production.

The loss of power production caused by the steam consumption of the heat pumps is system specific and cannot be tabulated here. If electrically driven heat pumps had been used instead, the power production loss would be avoided, but instead the heat pump would consume power themselves. Please refer to the heat pump technology sheets for more information.

### Total energy efficiency determination with flue gas condensation

Flue gas condensation is a technology that can significantly increase the heat efficiency of biomass and WtE plants by recovering the heat of condensation from water vapour in the flue gases. It is now implemented at the majority of the WtE plants (more than 70% of the installed capacity in 2018, [5]) and at most biomass plants in Denmark.

The heat of condensation is not included in the heating value definition of the lower heating value, LHV, which is usually used in Europe as basis for defining the energy input. Thus, total efficiencies based on LHV at plants with flue gas condensation may exceed 100%. Furthermore, the total efficiency of such plants can vary significantly for different fuels with different compositions and moisture contents when using the LHV as the basis.

For flue gas condensation the relevant heating value definition to describe the heat recovery and the total plant efficiency is the higher heating value (HHV), which takes into account the energy recovery potential from condensation. Thus, we will in the specific section below need to make references to the HHV. The rest of the technology data sections as well as all the data tables will refer to the usual LHV only. The total HHV-based efficiency of a given plant with flue gas condensation is almost the same for any fuel, when the flue gasses are cooled, and water vapour condensed to a certain temperature. The total HHV-based efficiency with flue gas condensation depends mainly on the temperature of the DH return water, which is used to recover the low temperature heat through heat exchange.

Figure 15 shows the HHV-based total gross efficiency for typical biomass plants and WtE plants. This curve is generally applicable to such plants, for CHP as well as heat only configurations. Biomass plants with flue gas condensation have slightly higher HHV-based gross efficiencies because they typically operate with lower excess air ratios and have lower ash loss than WtE plants. The dashed boiler efficiency indications in Figure 15 show the no-condensation lower efficiency limit, which is fuel specific. Wood chips were selected for the example to give a low lower limit.

### Total HHV-based efficiency, flue gas condensation

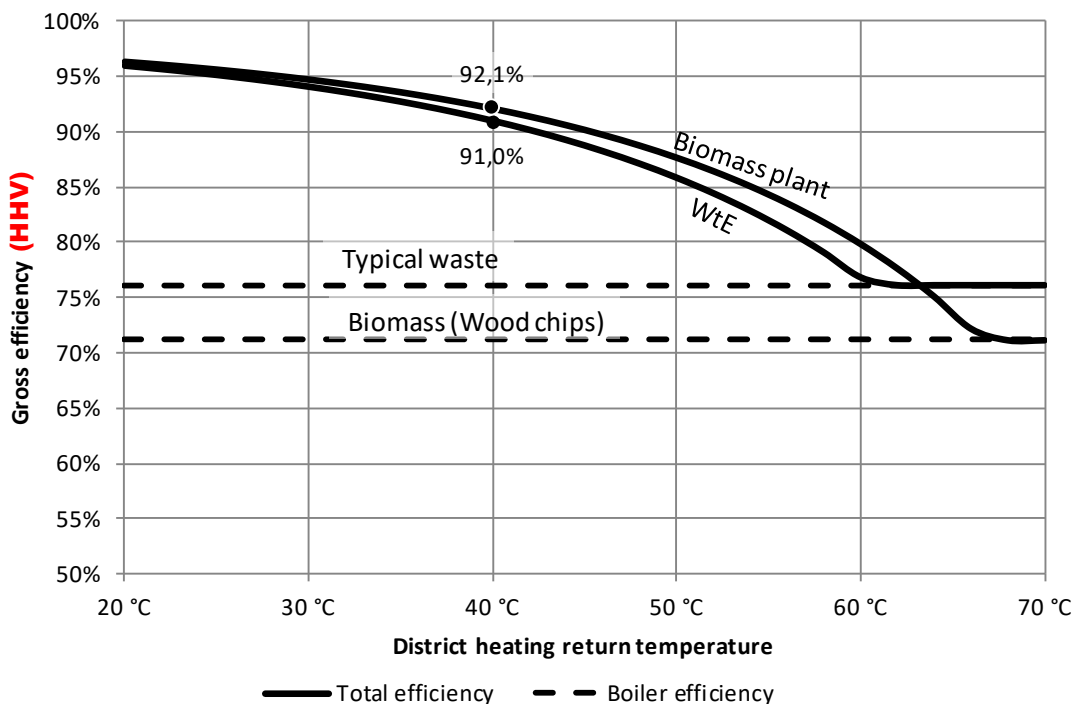

Figure 9. Total HHV-based efficiency estimate for WtE plants<sup>7</sup> and biomass plants<sup>8</sup> given varying DH return temperatures [5] – or temperature of the cold media of a heat pump.

Figure 15 can be used generally with good accuracy to estimate the total efficiency (based on HHV) of a WtE or solid biomass plant equipped with flue gas condensation, based only on the available DH return temperature. The estimate is even valid for marginal efficiencies of single waste fractions such as organic waste, paper, plastics etc. The conversion to the usual LHV-based total efficiency is straight-forward. As an example, typical municipal solid waste with a LHV of 10.6 MJ/kg and a HHV of 12.2 MJ/kg treated at a plant with flue gas condensation fed with 40°C DH water would according to Figure 15 have a total efficiency of 91.0% based on HHV. This can be calculated to the LHV-based gross total energy efficiency as:  $91.0\% \cdot \frac{12.2 \text{ MJ/kg}}{10.6 \text{ MJ/kg}} = 104.7\%$ . For wet organic waste with a HHV of 6.5 MJ/kg and LHV of 4.4 MJ/kg treated at the same plant, gross total energy efficiency would be  $91.0\% \cdot \frac{6.5 \text{ MJ/kg}}{4.4 \text{ MJ/kg}} = 134.9\%$ . Table 2 shows examples of gross total efficiencies calculated the same way for different fuels at WtE and biomass plants connected to DH networks with return temperatures of 50, 40 and 30°C.

| Gross total efficiencies with flue gas condensation | Heating value |             | Total efficiency (LHV) |         |         |
|---|---------------|-------------|------------------------|---------|---------|
|   | LHV [MJ/kg]   | HHV [MJ/kg] | DH 50°C                | DH 40°C | DH 30°C |
| Fuel or fuel fraction                               |               |             |                        |         |         |

<sup>7</sup> Assumptions for WtE: Excess air ratio λ=1.5. Ash content 25% of dry matter. Flue gases cooled to 2°C above the DH return temperature. The efficiencies may not exactly match the ones listed in the data-tables due to slight differences in preconditions.

<sup>8</sup> Assumptions for biomass: Excess air ratio λ=1.3. Wood chips with an ash content of 2% of dry matter. Flue gases cooled to 2°C above the DH return temperature. The efficiencies may not exactly match the ones listed in the data-tables due to slight differences in preconditions.

|   |      |      |        |        |        |
|---|------|------|--------|--------|--------|
| WtE configuration HHV boiler efficiency (from Figure 7)     |      |      | 85.8%  | 91.0%  | 94.1%  |
| Mixed waste 10.6 GJ/t (31% moisture)                        | 10.6 | 12.2 | 98.8%  | 104.7% | 108.3% |
| Organic waste (70% moisture)                                | 4.4  | 6.5  | 127.3% | 134.9% | 139.5% |
| Green waste (50% moisture)                                  | 9.5  | 11.5 | 103.4% | 109.6% | 113.3% |
| Paper   | 11.1 | 12.6 | 97.4%  | 103.3% | 106.8% |
| Plastic   | 35.0 | 37.5 | 91.9%  | 97.5%  | 100.8% |
| Biomass configuration HHV boiler efficiency (from Figure 7) |      |      | 87.7%  | 92.1%  | 94.7%  |
| Wood chips (50% moisture)                                   | 8.1  | 10.0 | 107.7% | 113.1% | 116.3% |
| Wood chips (40% moisture)                                   | 10.3 | 12.0 | 102.5% | 107.7% | 110.8% |
| Wood pellets (5% moisture)                                  | 17.7 | 19.0 | 94.3%  | 99.0%  | 101.9% |
| Straw (11% moisture)  | 15.0 | 16.4 | 95.8%  | 100.6% | 103.5% |

**Table 3 Gross total efficiencies for different fuels at biomass and waste fired plants with access to different DH return temperatures using flue gas condensation.**

At some plants, large heat pumps have been installed to supply condenser cooling water at even lower temperatures than the DH return temperature in order to further increase the heat recovery. In these cases, the total efficiency can still be read from Figure 15 by replacing the DH return temperature on the x-axis by the (lower) chilled water temperature from the heat pump. The use of a heat pump to extend the flue gas condensation is considered an add-on, the feasibility of which is judged as a separate project (cf. technology sheets on heat pumps). The heat pump constitutes most of the necessary additional investment.

Even higher total efficiencies can be achieved by recovering the heat from component cooling at the plant, which is usually lost. This would require the use of heat pumps. Recovery of component cooling energy is being implemented both at the WtE plants Amager Bakke and Fjernvarme Fyn in Odense during 2017, both reaching total net total efficiencies around 105-110 %.

All efficiencies in the main data tables of all ENS technology data sheets are given based on the usual LHV basis for the specifically assumed waste and biomass composition. Given other waste or biomass compositions, the total efficiency at plants with flue gas condensation is much more accurately estimated using the table or procedure described above with the given fuel. The power efficiency should however be taken directly from the technology data sheets, as it is not significantly affected by flue gas condensation.

## Financial data

### Investment

The CAPEX is based on green-field construction and the investment cost includes engineering, procurement and construction, in which a lot-based tendering approach is selected to reach a turn-key plant. This approach is in accordance with the most common practice in Denmark.

The pricing reference and distribution of cost between contract nominal price and project cost is based on tendering in relatively large lots, including a separate civils lot and 3 major M&E lots, e.g. furnace/boiler, flue gas treatment and turbine/generator. There may be some minor lots to make the balance of plant. The typical civils cost is 30% of total construction cost and project cost typically amounts to 15% of total construction cost (total construction cost excluding project cost).

The project cost includes:

- Owner's organisation
- Owner's or consultants' fees related to procurement, and design, construction and commissioning surveillance
- Insurances
- Contingencies
- Hedging of currency exchange rates related to contracts
- Utilities connections etc. (power, water, district-heating)
- Roads, manoeuvring space and parking on site for staff and visitors
- Visitor facilities, basic to accommodate school classes and the like.

Following are not included:

- Land acquisition – and preparation
- Pre-development cost
- Approvals, environmental and others
- Infrastructure outside site (roads, power connections, district-heating piping, sewage)
- Financing cost other than specifically included above
- Interest payments during construction
- Any cost related to operation after take-over
- Financial risk element associated with acquisition of waste (waste is assumed available)
- Financial risk element associated with sale of heat and power (sale opportunity of power is considered available, and 100% sale of heat is considered available in the heating season, 5000-6000 h/y, but there may be limited sale in the summer)
- Demolition of existing constructions on site
- Site preparation such as relocation of infrastructure elements (e.g. gas-, water- and DH-piping, sewage systems, electric cables, etc.)
- Adaptions to a restricted footprint of the available site, e.g. brown-field plants and construction in proximity to cities.
- Particular architectural features and designs.
- Particular visitor facilities other than basic.

For EPC–contracts, i.e. contracts in which the entire plant includes engineering and commissioning is contracted as a turn-key project, the CAPEX is estimated as roughly unchanged or slightly higher. There could be higher cost to allow for the Contractor’s project management and assumed risk compared to a lot-based approach, but particularly at small plants this may be counteracted by savings if the Contractor has experiences with working closely together with sub-suppliers. At larger plants the owner would often prefer to procure the plant in lots to ensure control of the technical specification and execution of major subsystems and the civils works. In such cases using an EPC contract may release some additional cost. The cost also depends on the risk allocation and the details of the technical description of the tender documents.

In summary the additional cost of an EPC contract is estimated as 0-10%. This only relates to a lot-based approach compared with an EPC-contract in the construction of a plant. The plant ownership, the owner’s responsibility for the operation and the other risk elements described above must not be affected by the contracting approach.

Comparing heat-only plants (HOP) with CHP plants will show relatively large difference in investment costs expressed in €/MW input. This is because CAPEX for CHP plants will include a steam boiler with associated high-pressure systems, steam turbine with auxiliary equipment, a generator with step-up transformer, switchyard, control system etc. and a steam turbine/generator building, which a HOP does not require.

Furthermore, when comparing investment costs expressed as €/MW input for the same category, e.g. wood chip fired HOP, this will show a declining trend as unit size increase and the decline will typically be greatest for small plants up to say 30-40 MW fired capacity after which it will even out to an almost constant figure.

The investment costs are also influenced by legislative requirements for emission to air which will shift depending on heat input. For biomass fired plants more stringent requirements come into force when the heat input is 50 MW or higher which will require more sophisticated flue gas cleaning equipment and may also increase O&M costs.

### Operation and Maintenance

O&M-costs are composed of the following components in relation to their dependence on plant production:

#### Variable O&M:

- Consumables (water, lubricants, oils, chemicals, additives, absorbents, etc.)
- Effluent charges for disposal of condensate from flue gas condenser
- Electricity consumption (lighting excluded as this appears as auxiliary electricity consumption)
- Temporary staff
- Other

#### Fixed O&M:

- Administration cost, tests (e.g. R&D, office equipment and utensils, utilities, vehicles, cleaning, etc.)
- Operating staff
- Maintenance staff
- Planned and unplanned maintenance costs (spare and wear parts, tools and scaffolding, external work force, etc.)
- Service agreements
- Property taxes
- Network and system charges
- Insurances
- Other

O&M costs are high-level estimates based on experience rather than detailed analyses of cost elements shown in above lists. As for CAPEX estimates O&M costs for a greenfield, stand-alone plant is envisaged meaning that any resources or facilities potentially shared with other units are not considered. In case of plants established as extension to existing and similar plants, where shared manning, O&M facilities and partly unmanned/remote operation are good opportunities, substantial cost reductions can be obtained, but such cases need to be analysed individually to quantify.



Fixed O&M costs are estimated with the following elements:

- fixed maintenance cost for process plant (M&E) calculated as 2% p.a. of the M&E CAPEX
- fixed maintenance cost for civil structures calculated as 1% p.a. of civil CAPEX,
- other fixed O&M costs estimated individually for all scenarios,
- fixed staff for a stand-alone plant with permanent manning of control room and including staff administrative tasks.

Variable O&M costs are estimated with the following elements:

- consumables used for the specific case,
- estimated costs for disposal of excess recovered condensate from flue gas condenser,
- other variable O&M costs for the specific case covering the rest in above list.

Excess recovered condensate is included in the data tables and included as variable operating cost at a rate of 1 € per tonne of water. The variable cost is very dependent on the opportunities available locally. It may be zero if internal or external use could be the off-taker, or if outlet to the sea (or another recipient) is possible. In case of discharge to the local public sewage system, the unit pricing is locally dependent and dependent on annual volume. It would usually be in the range 1.5-4 € per tonne of water.

### References:

- [1] Dansk Fjernvarme, Input and comments 2015, 2017, not published
- [2] ARC, Kirstine Hansen, Email 2015-05-07.
- [3] Vestforbrænding I/S, Grønt regnskab (Green accounts) of 2013 and 2015, respectively. Available at <http://www.vestfor.dk/Om-Vestforbraending/Nogletal> (last visited 01.08.2018).
- [4] Veronica Martinez-Sanchez, Tore Hulgaard, Claus Hindsgaul, Christian Riber, Bettina Kamuk, Thomas F. Astrup; Estimation of marginal costs at existing waste treatment facilities, Article in Waste Management 50, p 364-375· March 2016.
- [5] Ramboll, internal statistics and calculations. Not published.
- [6] Danish Energy Agency, Second act of project evaluation for district heating, §11. Available at <https://www.retsinformation.dk/Forms/R0710.aspx?id=183229> (last visited 01.08.2018).
- [7] Danish environmental protection agency, Tilslutning af industrispildevand til offentlige spildevandsanlæg, Vejledning fra Miljøstyrelsen Nr. 2 2006 (guideline on connection of industrial wastewater to municipal wastewater treatment facilities, in Danish), <https://www2.mst.dk/udgiv/publikationer/2006/87-7052-055-0/pdf/87-7052-055-0.pdf>.

## 08 WtE CHP and HOP plants

### Contact information:

Danish Energy Agency: Jacob Hjerrild Zeuthen/Filip Gamborg

Author: Claus Hindsgaul, Tore Hulgaard, Rambøll

### Publication date

March 2018

### Amendments after publication date

| Date           | Ref.                 | Description  |
|----------------|----------------------|--|
| February 2023  | 08 WtE CHP and HOP   | Updated info on operation of Amager Bakke power plant  |
| January 2020   | 08 WtE CHP and HOP   | Revised qualitative- and quantitative description. Among adjustments in datasheets are efficiencies, distribution between variable and fixed O&M and notes.<br><br>Addition of 50/100 °C datasheets for large backpressure units |
| September 2018 | 08 Waste CHP and HOP | Updated qualitative description and merging of CHP and HOP descriptions  |

## Qualitative description

### Brief technology description

WtE plants incinerate waste and produce energy. HOP's produce only heat, while CHP's also produce electricity.

Flue gas condensation technology was introduced at WtE plants in Denmark in 2004 and has been installed in every new built WtE line in Denmark since 2007. It recovers the heat of condensation of the flue gas content of water vapour. The heat i.e. recovered as low temperature heat and thereby increases the energy efficiency by additional 10-25%-points for mixed waste.

Common technology description for biomass and WtE is found in Introduction to Waste and Biomass plants. Also, flue gas condensation, combustion air humidification, fuels and an improved energy model for technology data is described there.

### Input

The fuels used in WtE plants include mainly municipal solid waste (MSW) and other combustible non-recyclable wastes. Biomass may be used mainly for starting up and closing down. Some plants in Denmark are feeding green waste from gardens and parks and challenging forest residues such as stubs. In addition, imported Refuse Derived Fuel (RDF) may be used as fuel. Other fuels include gasoil or natural gas for burners used mainly for start-up.

The fuel, waste, is characterised by being heterogeneous having large variation in physical appearance, heating value and chemical composition. The heating value of the waste fed to the furnace is a result of controlled mixing of available waste sources fed to the bunker of the WtE facility. It is usually in the range 7-15 MJ/kg, typically averaging 10-11 MJ/kg, referring to the lower heating value, LHV. For instance, the average heating value was 9.5 MJ/kg varying from 8-11 MJ/kg in 2014 in the WtE facility owned by Amager Resource Center (ARC) in the Copenhagen area. At the time ARC had about 50% waste from trade and industry, which is a high ratio in Denmark [2].

The table below shows the trend of the heating value at Vestforbrænding I/S – the largest MSW plant in Denmark, and also located in the Copenhagen area.

| Year  | 2011  | 2012  | 2013 | 2014 | 2015 |
|-------|-------|-------|------|------|------|
| MJ/kg | 10.32 | 10.30 | 9.80 | 10.0 | 10.4 |

**Table 4 Development of lower heating value at Vestforbrænding, Denmark. [3]**

The heating value of the waste received at the WtE plants may be affected by increased focus on recycling, which on one hand may divert organic waste with relatively low heating value and on the other hand divert plastics, paper and wood with relatively high heating value. Many Danish WtE plants are importing RDF waste with relatively high heating value.

### Output

The products from WtE CHP plants are electricity and heat as steam, hot (> 110°C) or warm (< 110°C) water.

The output from WtE HOP is hot water for district heat or low-pressure steam for industrial purposes. The energy efficiency of the WtE plant has increased over the last decade, driven by focus on combustion control, limiting the flue gas temperature at boiler exit and the excess air level, assisted by the increased use of flue gas condensation [7] and [8]. The total energy efficiency is identical for heat and CHP plants, except that for HOP some minor heat losses in the generator and turbine gearbox of the CHP plant is avoided. The heat production from a HOP is thus identical (or slightly higher) than the sum of produced electricity and heat from an equivalent CHP plant.

In case of flue gas condensation, excess condensate (which represents up to 50% of mass input of waste) may be upgraded to high quality water useful for technical purposes such as boiler water or for covering water losses of the district-heating network.

### Typical capacities

The capacity of a WtE plant is typically in the range 10-35 tonnes of waste per hour, corresponding to a thermal input of approx. 30 - 110 MW. The furnace capacity is limited to around 120 MW thermal input at the current state of development.

WtE HOPs are typically relatively small with a capacity of 5-15 tonnes of waste per hour, corresponding to a thermal input in the range 15-50 MW.

The initial costs for WtE CHP plants are so high that smaller plants (< 5-10 t waste/h) are rarely financially attractive. The typical production line has a capacity of 10-35 t waste/h. More lines are installed if required. In Scandinavia WtE plants are typically located close to larger cities with a district heating system and they are designed to treat the waste amounts produced in the vicinity. During periods where local waste generation is below the treatment capacity, it is possible to supplement with waste from other regions, including imported waste (as RDF). The size of the moving grate defines the upper limit waste mass capacity for each boiler line (approximately 40 t waste/h).

### Regulation ability and other power system services

The CHP plants can be down regulated to about 70 % of the nominal capacity. Below the limit the boiler may not be capable of providing adequate steam quality and compliance with the requirement of high temperature residence time of the flue gas, cf. environmental section. WtE plants are preferably operated as base load due to high initial investments and that longer term storage of some types of waste is problematic and therefore it must be incinerated continuously. This also ensures continuous district-heating supply. In order to be able to maintain a waste treatment capacity (and heat supply) during outages WtE plants are sometimes built as 2 (or more) parallel lines instead of one large unit depending on alternative disposal options of waste.

Most CHP facilities are constructed with fully flexible and fast reacting electricity production meaning that the turbine may be taken in or out of operation through the use of a turbine by-pass, which may also be used partly. When the turbine is out, the output is 100% heat for district-heating, and furnace/boiler operation continues unaffected. Turbine operation can usually be maintained down to around 15% of nameplate load.

### Advantages/disadvantages

A WtE plant is not just an energy producing unit but a multi-purpose facility. Main purpose is the treatment of waste by which the waste is sterilised, and its mass and volume are greatly reduced. Compared to landfilling and anaerobic digestion the WtE prevents emissions of methane, a powerful greenhouse gas, from the waste handling.

Recovery of energy from waste is a main feature for resource recovery as part of the circular economy system for waste. It provides the opportunity of recovering resource from wastes that are not recyclable, e.g. contaminated waste, rejects from recycling operations and wastes that are too demanding to recycle [14].

The energy recovery process also provides the opportunities of recovering secondary raw materials from waste such as metals eventually replacing virgin metals produced from excavated metal ore. Metals (including iron, steel, aluminium and copper) are recovered from the bottom ashes. Metals contained in compound waste products that would otherwise be difficult to recycle may be recycled after the thermal treatment in the WtE facility. The remaining bottom ash is used as aggregate for road construction. Furthermore, clean water may be recovered as a result of flue gas condensation.

The disadvantage is that a polluted, corrosive flue gas is formed, requiring extensive treatment, and that the flue gas treatment generates residues usually classified as hazardous waste. The capital costs are relatively high due to the flue gas treatment system, other environmental requirements, the heterogeneous nature of the fuel and corrosive properties of the flue gas. The corrosive nature of the flue gas also limits the permissible steam data to approximately 40 - 70 bar and 400-440°C [10] and hence the net power efficiency to around 20-30%. Due to the corrosive flue gasses the hottest parts of new boilers are often coated with expensive corrosion resistant alloys (Inconel).

The main advantage of a WtE HOP compared to a WtE CHP plant is lower investment and maintenance costs.

The main disadvantage of a WtE HOP is the lack of electricity sale and thus lower energy sales revenue and higher dependence on the sale of energy at the local heat market.

### Environment

The environmental impact includes emissions to air and water, bottom ash (slag), and residues from flue gas treatment, including fly ash. Bottom ash making up around 15% of the mass input of waste is sorted to recover metals for recycling and production of aggregates for road construction.

Flue gas treatment residues and fly ash (totalling around 2-4% of the mass input of waste) are treated, e.g. through neutralisation with similar acid residues, and stored in a geologically stable underground deposit designed for the purpose. If the flue gas is treated by wet methods, there may also be an output of chloride containing waste water, which is treated at the plant to a purity that fulfils the requirements for discharge to the municipal sewerage system or to the sea. The discharged chloride salt substitutes deposition of a large quantity of solid residue.

On the positive side the recovered energy replaces energy produced from other resources and the emissions from this production, and recovered metals replace metals production from virgin ore.

Excess condensate from flue gas condensation may be considered a secondary raw material recycled for replacing water for technical purposes such as covering losses of district-heating networks to which the energy system is attached. The flue gas condensation system is usually located downstream of the flue gas treatment system, making the condensate low in salts and pollutants when leaving the condenser. The condensate could be treated further by electro deionization (EDI) and reverse osmosis to reach the quality required for its subsequent use or discharge to sensitive water recipients.

The air emissions from energy recovery of waste must comply with the environmental permit setting limit values on a range of pollutants including dust, CO, total organic carbon (TOC), HCl, SO<sub>2</sub>, HF, NO<sub>x</sub>, heavy metals and dioxins/furans. The limit values are based on the EU Industrial Emissions Directive (IED, [15]) of 2010 and the EU reference note on best available techniques for waste incineration (BAT-reference note or BREF [1]) supplemented by assessment of local conditions. Energy recovery also involves the generation of climate-relevant emissions of which mainly CO<sub>2</sub> and N<sub>2</sub>O may be contributors. Methane, CH<sub>4</sub>, is not emitted in any significant amount. It is destroyed in the combustion process and its potential emission included under the restrictive limit value of TOC.

Waste is a mixture of CO<sub>2</sub> neutral biomass and products of fossil origin, which are mostly plastics. The CO<sub>2</sub>-emission from energy recovery of plastics is defined as fossil CO<sub>2</sub> emitted from the WtE-facility. Typically, 32% ±5% of the emitted CO<sub>2</sub> originates from fossil sources [3].

A typical emission factor for fossil CO<sub>2</sub> is 37.0 kg/GJ (LHV-basis) for the waste mixture currently incinerated in Denmark.

The IED includes a residence time requirement of the hot flue gas, meaning that the flue gas must be heated to min. 850°C for at least 2 seconds after the last air injection. This is to ensure conditions for complete burnout of the combustible gases and hence, ensure low emissions of CO, TOC and dioxins. HCl, HF and SO<sub>2</sub> are captured in the course of flue gas treatment and leave the facility in the solid flue gas treatment residue in the case of a dry or semi-dry FGT process. In case HCl, HF and SO<sub>2</sub> are removed by wet processes, the chloride in HCl will instead leave the facility in a chloride containing wastewater stream, which is treated to fulfil the local water emission limit values in addition to the IED limit values.

In general, political and economic framework conditions define the emission limits from WtE. A revised BAT reference note has been published in draft in 2017. The implications in terms of revised environmental requirements in the final version are uncertain.

Decision on pollutant abatement technology and hence, emission levels, are also affected by taxation. Currently (2018) emission tax is imposed on NO<sub>x</sub> and SO<sub>2</sub>.

Technical development in deNO<sub>x</sub>-technology and gradually more stringent emission requirements are expected to lower emissions of NO<sub>x</sub> for new facilities.

The solid residues from treatment of flue gas and wastewater are classified as hazardous wastes and they are usually treated before they are placed in an underground storage for hazardous waste (cf. Council Decision 2003/33) [17].

### Research and development perspectives

The electrical efficiency of WtE CHPs may be increased with higher steam temperature and pressure. However, this may reduce the lifetime of the super-heater, due to corrosion by chloride and other aggressive ingredients in the flue gas, thereby increasing super-heater replacement rates and/or decreasing the operational availability. Simple solutions, which are common in the US, are to replace the super-heater regularly, and to protect the super-heater with a layer of Inconel, a corrosion resistant alloy. Another solution is to use a clean fuel (e.g. natural gas or self-produced gas) for heating an external super-heater, as implemented at MEC Bioheat & Power (formerly 'Måbjergværket'), Holstebro. A novel proposed solution ("Steamboost" being developed by company Babcock & Wilcox Vølund) is to separate a less corrosive part of the flue gas from the last part of the furnace. An additional high temperature superheater installed in this flue gas can increase the steam temperature from the usual 400-440 °C to 480 °C. Operating at a higher temperature the new superheater will increase the electricity efficiency by 3-6 percentage points [12].

Technology with net power efficiency 25% is available now (up to 30% for power-only) but the future development is depending on the price on electrical power, which is currently low in Denmark. New plants are optimised for best net present value over the planning period which currently makes it unattractive to strive for very high power efficiency considering the increased capital cost and risk of corrosion. Optimisation may even question the concept of CHP compared to heat only boilers, depending on forecast of electricity prices and heat market availability and pricing. In

Denmark, Scandinavia and other countries having district heating systems we expect the total energy efficiency to increase in the future due to increased penetration of flue gas condensation possibly augmented by combustion air humidification, and decreasing return temperatures from the district heating (please, refer to Examples of best available technology).

Other energy conversion technologies may find its place such as organic rankine cycle (ORC), the use of which may significantly reduce the capital cost of a plant at the expense of some percent points of power generation efficiency.

Combustion air humidification is a method to increase the energy recovery by flue gas condensation without using a heat pump, as described in the Introduction to Waste and biomass. This technology is in successful use in several biomass plants in particularly Sweden and Finland. Combustion air humidification is expected to be introduced at the first WtE plant in Denmark within a few years.

Similarly, the amount of hazardous waste (fly ash and flue gas cleaning residue) may be reduced by optimisation of the overall process. In addition, treatment of residues may be further developed for recovery of salts and metals Zinc, in particular. Treatment may also render the residue non-hazardous easing the landfilling and possibly over time and development allowing use for construction purposes.

Advances in the metal recovery from the bottom ashes may increase the recycling rate. Dry bottom ash extraction systems are demonstrated at plants in Switzerland and allow increased metal recovery rates as sub-millimetre metal particles can be extracted and mechanically sorted in a non-corroded form. Even for wet extracted bottom ash metals recovery is expected to increase significantly through further development of sorting systems.

### Prediction of performance and cost

When it comes to technological maturity, WtE is under Category 4, *Commercial technologies, with large deployment*. The technology has been used for 50 years, and more than 400 WtE plants are currently in operation in Europe most of which produce electricity and many of which are CHP-facilities, mainly in the Northern Europe [16].

### Examples of market standard technology

Amager Bakke at ARC put in operation in 2017 has a waste capacity of 2 x 35 tonnes/hour, steam data 440°C and 70 bars. It is equipped with flue gas condensation augmented by large heat pumps that cool the flue gas to 22°C. The net power efficiency and total energy efficiency based on a lower heating value of 11.5 MJ/kg depends on the selected operation [11]:

CHP-operation without heat pumps:  $\eta_{el}$ : 25%,  $\eta_{total}$ : 95%

CHP-operation with heat pumps:  $\eta_{el}$ : 22%,  $\eta_{total}$ : 107%

Amager Bakke is expected to be one of the WtE plants with the highest total energy efficiency in the world. Only Fjernvarme Fyn in Odense will achieve a similar total efficiency when heat pump assisted flue gas condensation cooling the flue gas to 24°C is implemented here during 2017.

Since 2017 and up to 2020 based on later knowledge about the operation at Amager Bakke after the first publication of the chapter, the actual total energy efficiency was between 81% - 104%, of which  $\eta_{th}$  was between 64% - 88% and  $\eta_{el}$  between 13 - 18%, which are lower ranges than the initial expectations.

The Afval Energie Bedrijf in Amsterdam is the largest incineration plant in the world (1.5 million tonnes per year). The most recent extension (2007) involved 2 units of 34 tonnes/hour, steam data 440°C and 130 bar and river cooled condensers, which together with steam re-heating results in a net electricity efficiency of 30% when producing power-only [2]. This is the current world record power efficiency for WtE plants.

### Uncertainty

The amount and the heating value of the available waste are dynamic properties, which change with time. Waste sorting (at source and central) and liberalization of commercial waste in DK are factors that might reduce the amount of residual waste and change its properties. In Sweden, relatively high recycling rates have not significantly changed the heating value of waste used in WtE.

Other more exotic processes such as thermal gasification may in a distant future develop and take over specific fractions from WtE.

### Additional remarks

Contrary to other fuels used for energy generation, waste has a negative price and is received at a gate fee. The primary objective of a waste-to-energy plant is the treatment of waste. Produced energy may be considered a useful by-product although with increasing importance for the future Danish energy system with extensive use of district-heating and high power production from wind. The total energy production from a WtE boiler can be varied by varying the fuel feed, although WtE facilities run at full load most of the time if the district-heating demand allows together with additional cooling opportunities. Operation of WtE CHP-unit as power-only may not be financially attractive, and often CHP facilities are constructed so that operation at power-only is not physically possible, as the necessary cooling facilities are not in place. The heat production can be changed also by starting or stopping the flue gas condensation. The electricity production is usually fully flexible from CHP plants because the turbine can be by-passed fully or partly at short notice and the rate of change may be as high as the turbine allows. The heat generation is thus changed corresponding to the change in electricity generation.

A World Bank study projects a 70% global increase in urban solid waste – with developing countries facing the greatest challenges. The projected rise in the amount of waste, from 1.3 billion tonnes per year today to 2.2 billion tonnes per year by 2025, is expected to raise the annual global costs from \$205 billion to \$375 billion [5].

Even in Europe, the potential for WtE is huge. Only 6 countries have reduced the amount of municipal waste landfilled to a minimum: Austria, Belgium, Denmark, Germany, the Netherlands and Sweden landfill only 4% of municipal waste or less. They have all introduced landfill bans of combustible waste and worked towards a complementary waste management system where both recycling and waste-to-energy play a role in diverting waste from landfills (diagram below).

In a Danish perspective this may provide an opportunity of offering waste treatment at high resource efficiency by WtE-facilities from which virtually all energy is used. At the same time waste would replace the import of other fuels in the energy system. And with payment following the waste import, the treatment and energy recovery effectively becomes an export activity with a potentially advantageous business case.

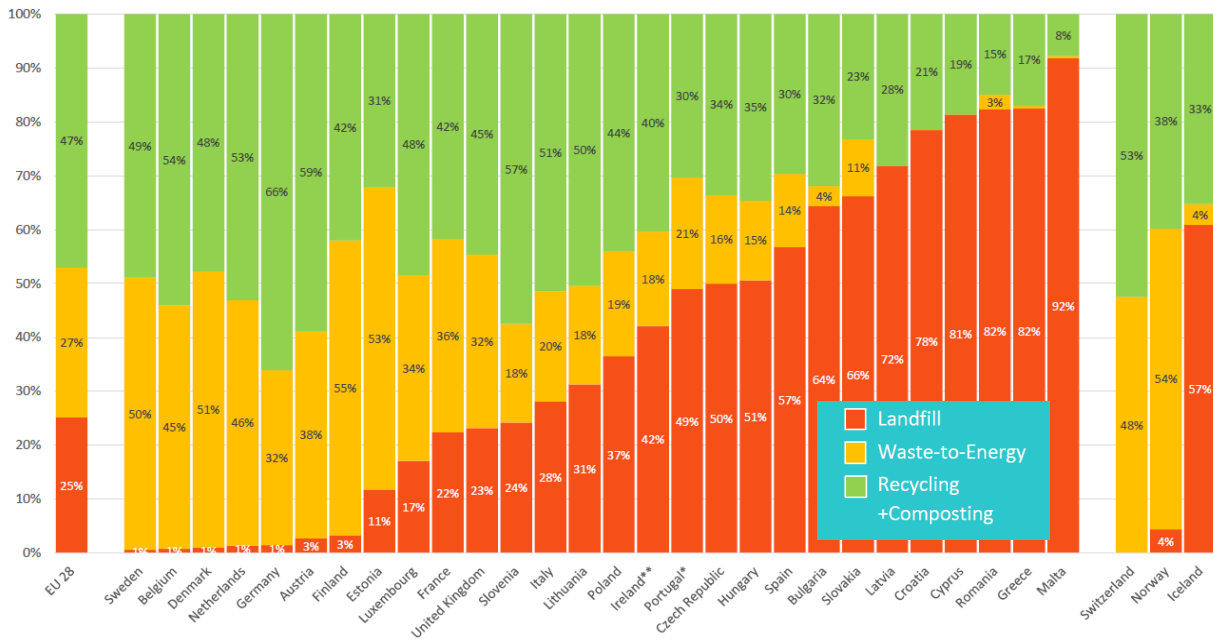

Figure 10 Waste management in Europe in 2016, Graph by CEWEP [4]. Source: EUROSTAT.

More information on development perspectives and future demand are published by various stake holders, plant manufacturers and World Bank, for example:

- [www.cewep.eu](http://www.cewep.eu)
- [www.eswet.eu](http://www.eswet.eu)
- [www.worldbank.org](http://www.worldbank.org)
- [www.iswa.org](http://www.iswa.org)



## References

- [1] Reference Document on the Best Available Techniques for Waste Incineration' (BREF), Europe-an Commission, August 2006, and draft revised edition of May 2017, available from <http://eippcb.jrc.ec.europa.eu/reference/> (last visited 01.08.2018).
- [2] <http://www.aebamsterdam.com/>
- [3] PSO-0213: Biogenic Carbon in Danish Combustible Waste
- [4] <http://www.cewep.eu/wp-content/uploads/2017/07/Graph-3-treatments-2016.pdf>
- [5] <http://www.worldbank.org/en/news/feature/2012/06/06/report-shows-alarming-rise-in-amount-costs-of-garbage> (last visited 01.08.2018).
- [6] ARC, Kirstine Hansen, Email 2015-05-07.
- [7] Vestforbrænding I/S, Grønt regnskab (Green accounts) of 2013 and 2015, respectively. Available at <http://www.vestfor.dk/Om-Vestforbraending/Nogleletal> (last visited 01.08.2018).
- [8] Vestforbrænding I/S, Arne Nielsen, Email 2015-05-11.
- [10] Newsletter, Babcock Wilcox & Vølund, December 2012  
[http://www.volund.dk/News/2014/01/Newsletter/Amager\\_Bakke](http://www.volund.dk/News/2014/01/Newsletter/Amager_Bakke) (last visited 01.08.2018).
- [11] Inger Anette Søndergaard, Tore Hulgaard and Lasse Tobiasen; High Efficient Waste-to-Energy Facilities, in Karl. J. Thomé-Kozmiensky and Stephanie Thiel, Waste Management, vol 4 Waste-to-Energy, TK Verlag 2014.
- [12] Newsletter, Babcock Wilcox & Vølund, December 2016 <http://www.volund.dk/News/2016/12/08/SteamBoost> (last visited 01.08.2018).
- [13] Calculations by Rambøll. Not published.
- [14] Hulgaard, Tore; Circular economy: Energy and fuels, International Solid Waste Association, ISWA 2015, available from <http://www.iswa.org/iswa/iswa-groups/task-forces/> (last visited 01.08.2018).
- [15] Industrial Emissions Directive (IED), Directive 2010/75/EU of the European Parliament and of the Council of 24 November 2010 on industrial emissions (integrated pollution prevention and control).  
<http://ec.europa.eu/environment/industry/stationary/ied/legislation.htm> (last visited 01.08.2018).
- [16] ISWA, Waste-to-Energy, State-of-the-Art-Report, 6th edition, August 2012.
- [17] COUNCIL DECISION of 19 December 2002 establishing criteria and procedures for the acceptance of waste at landfills pursuant to Article 16 of and Annex II to Directive 1999/31/EC (2003/33/EC).

### Data sheets for WtE plants

The total efficiency of plants with flue gas condensation is calculated assuming “direct condensation”, where the condensation heat is recovered directly with the available DH water without the use of heat pumps.

Condensation heat recovery can be augmented by cooling the flue gas further, typically to 30°C using heat pumps. In the datasheets, the row “Additional heat potential for heat pump (%)” contains the additional heat that a heat pump would recover from the flue gas by cooling it further to 30°C. The so produced additional heat is the sum of this recovered amount of heat and any external driving energy (electricity or steam) supplied to drive the heat pump.

For more information see Introduction to Waste and Biomass plants.

Data sheets WtE CHP, small

Notes and references are common to all the datasheets and can be found below the last data sheet.

| Technology   | Small Waste to Energy CHP, Backpressure turbine, 35 MW feed |         |         |         |                    |         |                    |         |         |       |
|--|---|---------|---------|---------|--------------------|---------|--------------------|---------|---------|-------|
|  | 2015  | 2020    | 2030    | 2050    | Uncertainty (2020) |         | Uncertainty (2050) |         | Note    | Ref   |
| <b>Energy/technical data</b>                           |   |         |         |         | Lower              | Upper   | Lower              | Upper   |         |       |
| Generating capacity for one unit (MWe)                 | 8.0   | 8.0     | 8.1     | 8.3     | 7.2                | 8.6     | 7.2                | 9.2     | A, B    |       |
| Electricity efficiency, net (%), name plate            | 22.7  | 22.7    | 23.2    | 23.8    | 20                 | 25      | 20                 | 27      | A, B,C  |       |
| Electricity efficiency, net (%), annual average        | 21.6  | 21.6    | 22.0    | 22.6    | 18                 | 24      | 18                 | 25      | A, B,C  |       |
| Auxiliary electricity consumption (% of thermal input) | 2.9   | 2.9     | 2.9     | 2.9     | 2.1                | 3.2     | 1.7                | 3.3     | A, B    |       |
| Cb coefficient (40°C/80°C)                             | 0.29  | 0.29    | 0.29    | 0.30    | 0.26               | 0.31    | 0.26               | 0.33    | A, B    |       |
| Cv coefficient (40°C/80°C)                             | 1   | 1       | 1       | 1       | 1                  | 1       | 1                  | 1       | A, B, O |       |
| Forced outage (%)                                      | 1   | 1       | 1       | 1       | 1                  | 1       | 1                  | 1       |         | 1     |
| Planned outage (weeks per year)                        | 3.5   | 3.3     | 3.0     | 2.5     | 2.8                | 3.8     | 1.8                | 3.1     | E       | 1     |
| Technical lifetime (years)                             | 25  | 25      | 25      | 25      | 20                 | 35      | 20                 | 35      |         | 1     |
| Construction time (years)                              | 2.5   | 2.5     | 2.5     | 2.5     | 2                  | 3       | 1.5                | 3       |         | 1     |
| Space requirement (1000 m2/MWe)                        | 2.5   | 2.5     | 2.5     | 2.4     | 2.1                | 2.9     | 1.8                | 3.0     |         | 1     |
| <b>Regulation ability</b>                              |   |         |         |         |                    |         |                    |         |         |       |
| Primary regulation (% per 30 seconds)                  | NA  | NA      | NA      | NA      | NA                 | NA      | NA                 | NA      | F       |       |
| Secondary regulation (% per minute)                    | 10  | 10      | 10      | 10      | 10                 | 10      | 10                 | 10      | F, G    |       |
| Minimum load (% of full load)                          | 20  | 20      | 20      | 20      | 20                 | 20      | 20                 | 20      | F, G    |       |
| Warm start-up time (hours)                             | 0.5   | 0.5     | 0.5     | 0.5     | 0.5                | 0.5     | 0.5                | 0.5     | F, G    |       |
| Cold start-up time (hours)                             | 2   | 2       | 2       | 2       | 2                  | 2       | 2                  | 2       | F, G    |       |
| <b>Environment</b>                                     |   |         |         |         |                    |         |                    |         |         |       |
| SO <sub>2</sub> (degree of desulphuring, %)            | 99.8  | 99.8    | 99.8    | 99.8    | 99.0               | 99.9    | 99.5               | 99.9    | H       | 1     |
| NO <sub>x</sub> (g per GJ fuel)                        | 80  | 60      | 40      | 20      | 10                 | 60      | 10                 | 60      | I       | 2;3;5 |
| CH <sub>4</sub> (g per GJ fuel)                        | 0.3   | 0.1     | 0.1     | 0.1     | 0                  | 0.1     | 0                  | 0.1     |         | 2     |
| N <sub>2</sub> O (g per GJ fuel)                       | 1.2   | 1       | 1       | 1       | 1                  | 3       | 0                  | 1       | J       | 2     |
| Particles (g per GJ fuel)                              | 0.3   | 0.3     | 0.3     | 0.3     | 0.1                | 2       | 0.1                | 1       | J       | 2     |
| <b>Financial data</b>                                  |   |         |         |         |                    |         |                    |         |         |       |
| Nominal investment (M€/MWe)                            | 10.7  | 10.4    | 9.9     | 8.8     | 8.8                | 12.2    | 6.4                | 10.9    | N       | 1     |
| - of which equipment                                   | 6.6   | 6.5     | 6.3     | 5.5     | 5.5                | 7.7     | 4.0                | 6.9     | N       | 1     |
| - of which installation                                | 4.0   | 3.9     | 3.7     | 3.2     | 3.3                | 4.5     | 2.4                | 4.0     | M       | 1     |
| Fixed O&M (€/MWe/year)                                 | 425,000   | 411,000 | 382,000 | 328,000 | 349,000            | 478,000 | 242,000            | 408,000 | L       | 1     |
| Variable O&M (€/MWh_e)                                 | 25.9  | 25.9    | 25.4    | 24.7    | 22.0               | 29.8    | 18.6               | 30.9    | K       | 1     |
| <b>Technology specific data</b>                        |   |         |         |         |                    |         |                    |         |         |       |
| Steam reheat   | None  | None    | None    | None    | None               | None    | None               | None    |         |       |
| Flue gas condensation                                  | Yes   | Yes     | Yes     | Yes     | Yes                | Yes     | Yes                | Yes     | D       |       |
| Combustion air humidification                          | No  | No      | No      | No      | No                 | Yes     | No                 | Yes     | D       |       |
| Incineration capacity (Fuel input) (tonnes/h)          | 11.9  | 11.9    | 11.9    | 11.9    | 11.9               | 11.9    | 11.9               | 11.9    | A, B    |       |
| Output of recovered condensate (tonne/MWh_input)       | 0.11  | 0.11    | 0.11    | 0.12    | 0.10               | 0.14    | 0.10               | 0.14    | D, K    |       |
| Nominal investment (M€/MW fuel input)                  | 2.42  | 2.36    | 2.30    | 2.09    | 2.01               | 2.77    | 1.52               | 2.60    | N       | 1     |
| - of which equipment                                   | 1.90  | 1.47    | 1.46    | 1.32    | 1.25               | 1.75    | 0.95               | 1.64    | N       | 1     |

|  |        |        |        |        |        |         |        |        |         |     |
|--|--------|--------|--------|--------|--------|---------|--------|--------|---------|-----|
| - of which installation  | 1.16   | 0.89   | 0.85   | 0.77   | 0.76   | 1.03    | 0.58   | 0.96   | M       | 1   |
| Fixed O&M (€/MW input/year)                                    | 96,500 | 93,400 | 88,600 | 78,100 | 79,400 | 108,500 | 57,700 | 97,300 | L       | 1   |
| Variable O&M (€/MWh input) *                                   | 5.9    | 5.9    | 5.9    | 5.9    | 5.0    | 6.8     | 4.4    | 7.4    | K       | 1   |
| Nominal investment (€/(tonne/year))                            | 890    | 870    | 850    | 770    | 740    | 1,020   | 560    | 960    | N       | 1   |
| Fixed O&M (€/tonne)  | 36     | 34     | 33     | 29     | 29     | 40      | 21     | 36     | L       | 1;4 |
| Variable O&M (€/tonne)   | 17     | 17     | 17     | 17     | 15     | 20      | 13     | 22     | K       | 1;4 |
| Heat efficiency, net (%), name plate                           | 79.2   | 79.2   | 78.9   | 79.3   | 75     | 85      | 72     | 86     | A, B    |     |
| Heat efficiency, net (%), annual average                       | 80.3   | 80.3   | 80.1   | 80.5   | 77     | 86      | 74     | 88     | A, B, C |     |
| Additional heat potential with heat pumps (% of thermal input) | 4.2    | 4.2    | 4.0    | 3.9    | 1      | 6       | 1      | 6      | A, B, D |     |

Data sheets WtE CHP, medium

| Technology   | Medium Waste to Energy CHP, Backpressure turbine, 80 MW feed |         |         |         |                    |              |                    |              |         |       |
|--|--|---------|---------|---------|--------------------|--------------|--------------------|--------------|---------|-------|
|  | 2015   | 2020    | 2030    | 2050    | Uncertainty (2020) |              | Uncertainty (2050) |              | Note    | Ref   |
| <b>Energy/technical data</b>                           |  |         |         |         | <b>Lower</b>       | <b>Upper</b> | <b>Lower</b>       | <b>Upper</b> |         |       |
| Generating capacity for one unit (MWe)                 | 18.6   | 18.6    | 19.0    | 19.7    | 16.9               | 20.2         | 16.9               | 21.7         | A, B    |       |
| Electricity efficiency, net (%), name plate            | 23.3   | 23.3    | 23.8    | 24.6    | 21                 | 26           | 21                 | 28           | A, B,C  |       |
| Electricity efficiency, net (%), annual average        | 22.1   | 22.1    | 22.6    | 23.4    | 19                 | 25           | 19                 | 26           | A, B,C  |       |
| Auxiliary electricity consumption (% of thermal input) | 2.9  | 2.9     | 2.9     | 2.9     | 2.1                | 3.2          | 1.7                | 3.3          | A, B    |       |
| Cb coefficient (40°C/80°C)                             | 0.30   | 0.30    | 0.30    | 0.31    | 0.27               | 0.32         | 0.27               | 0.35         | A, B    |       |
| Cv coefficient (40°C/80°C)                             | 1  | 1       | 1       | 1       | 1                  | 1            | 1                  | 1            | A, B, O |       |
| Forced outage (%)                                      | 1.0  | 1.0     | 1.0     | 1.0     | 1.0                | 1.0          | 1.0                | 1.0          |         | 1     |
| Planned outage (weeks per year)                        | 3.0  | 2.9     | 2.6     | 2.1     | 2.4                | 3.3          | 1.6                | 2.6          | E       | 1     |
| Technical lifetime (years)                             | 25   | 25      | 25      | 25      | 20                 | 35           | 20                 | 35           |         | 1     |
| Construction time (years)                              | 2.5  | 2.5     | 2.5     | 2.5     | 2.0                | 3.0          | 1.5                | 3.0          |         | 1     |
| Space requirement (1000 m2/MWe)                        | 1.6  | 1.6     | 1.6     | 1.5     | 1.4                | 1.9          | 1.1                | 1.9          |         | 1     |
| <b>Regulation ability</b>                              |  |         |         |         |                    |              |                    |              |         |       |
| Primary regulation (% per 30 seconds)                  | 5.0  | 5.0     | 5.0     | 5.0     | 5.0                | 5.0          | 5.0                | 5.0          | F       |       |
| Secondary regulation (% per minute)                    | 10.0   | 10.0    | 10.0    | 10.0    | 10.0               | 10.0         | 10.0               | 10.0         | F, G    |       |
| Minimum load (% of full load)                          | 20.0   | 20.0    | 20.0    | 20.0    | 20.0               | 20.0         | 20.0               | 20.0         | F, G    |       |
| Warm start-up time (hours)                             | 0.5  | 0.5     | 0.5     | 0.5     | 0.5                | 0.5          | 0.5                | 0.5          | F, G    |       |
| Cold start-up time (hours)                             | 2.0  | 2.0     | 2.0     | 2.0     | 2.0                | 2.0          | 2.0                | 2.0          | F, G    |       |
| <b>Environment</b>                                     |  |         |         |         |                    |              |                    |              |         |       |
| SO <sub>2</sub> (degree of desulphuring, %)            | 99.8   | 99.8    | 99.8    | 99.8    | 99.0               | 99.9         | 99.5               | 99.9         | H       | 1     |
| NO <sub>x</sub> (g per GJ fuel)                        | 80   | 60      | 40      | 10      | 10                 | 60           | 10                 | 60           | I       | 2;3;5 |
| CH <sub>4</sub> (g per GJ fuel)                        | 0.3  | 0.1     | 0.1     | 0.1     | 0.0                | 0.1          | 0.0                | 0.1          |         | 2     |
| N <sub>2</sub> O (g per GJ fuel)                       | 1.2  | 1.0     | 1.0     | 1.0     | 1.0                | 3.0          | 0.0                | 1.0          | J       | 2     |
| Particles (g per GJ fuel)                              | 0.3  | 0.3     | 0.3     | 0.3     | 0.1                | 2.0          | 0.1                | 1.0          | J       | 2     |
| <b>Financial data</b>                                  |  |         |         |         |                    |              |                    |              |         |       |
| Nominal investment (M€/MWe)                            | 9.3  | 9.0     | 8.6     | 7.5     | 7.7                | 10.6         | 5.5                | 9.4          | N       | 1     |
| - of which equipment                                   | 5.6  | 5.5     | 5.3     | 4.7     | 4.7                | 6.5          | 3.3                | 5.8          | N       | 1     |
| - of which installation                                | 3.6  | 3.5     | 3.3     | 2.9     | 3.0                | 4.1          | 2.2                | 3.6          | M       | 1     |
| Fixed O&M (€/MWe/year)                                 | 298,000  | 262,000 | 245,000 | 209,000 | 223,000            | 306,000      | 154,000            | 260,000      | L       | 1     |
| Variable O&M (€/MWh_e)                                 | 25.3   | 25.3    | 24.7    | 23.9    | 21.5               | 29.1         | 18.0               | 29.9         | K       | 1     |

| Technology specific data                                       |        |        |        |        |        |        |        |        |         |     |
|--|--------|--------|--------|--------|--------|--------|--------|--------|---------|-----|
| Steam reheat   | None   | None   | None   | None   | None   | None   | None   | None   |         |     |
| Flue gas condensation  | Yes    | Yes    | Yes    | Yes    | Yes    | Yes    | Yes    | Yes    | D       |     |
| Combustion air humidification                                  | No     | No     | No     | No     | No     | Yes    | No     | Yes    | D       |     |
| Incineration capacity (Fuel input) (tonnes/h)                  | 27.2   | 27.2   | 27.2   | 27.2   | 27.2   | 27.2   | 27.2   | 27.2   | A, B    |     |
| Output of recovered condensate (tonne/MWh_input)               | 0.11   | 0.11   | 0.11   | 0.12   | 0.10   | 0.14   | 0.10   | 0.14   | D, K    |     |
| Nominal investment (M€/MW fuel input)                          | 2.15   | 2.10   | 2.05   | 1.86   | 1.78   | 2.46   | 1.35   | 2.31   | N       | 1   |
| - of which equipment   | 1.31   | 1.28   | 1.26   | 1.15   | 1.08   | 1.52   | 0.82   | 1.42   | N       | 1   |
| - of which installation  | 0.84   | 0.82   | 0.78   | 0.71   | 0.70   | 0.95   | 0.53   | 0.88   | M       | 1   |
| Fixed O&M (€/MW input/year)                                    | 69,300 | 61,000 | 58,200 | 51,400 | 51,900 | 71,200 | 37,800 | 64,000 | L       | 1   |
| Variable O&M (€/MWh input) *                                   | 5.9    | 5.9    | 5.9    | 5.9    | 5.0    | 6.8    | 4.4    | 7.4    | K       | 1   |
| Nominal investment (€/tonne/year)                              | 790    | 770    | 750    | 680    | 660    | 910    | 500    | 850    | N       | 1   |
| Fixed O&M (€/tonne)  | 26     | 22     | 21     | 19     | 19     | 26     | 14     | 24     | L       | 1;4 |
| Variable O&M (€/tonne)   | 17     | 17     | 17     | 17     | 15     | 20     | 13     | 22     | K       | 1;4 |
| Heat efficiency, net (%), name plate                           | 78.8   | 78.8   | 78.5   | 78.2   | 74     | 84     | 71     | 86     | A, B    |     |
| Heat efficiency, net (%), annual average                       | 80.0   | 80.0   | 79.7   | 79.4   | 76     | 85     | 73     | 88     | A, B, C |     |
| Additional heat potential with heat pumps (% of thermal input) | 4.2    | 4.2    | 4.0    | 3.7    | 1      | 6      | 1      | 6      | A, B, D |     |

Data sheets WtE CHP, large, 40/80 °C return/forward temperature

| Technology   | Large Waste to Energy CHP, Backpressure turbine, 220 MW feed |         |         |         |                    |         |                    |         |         |       |
|--|--|---------|---------|---------|--------------------|---------|--------------------|---------|---------|-------|
|  | 2015   | 2020    | 2030    | 2050    | Uncertainty (2020) |         | Uncertainty (2050) |         | Note    | Ref   |
| <b>Energy/technical data</b>                                 |  |         |         |         |                    |         |                    |         |         |       |
|  |  |         |         |         | Lower              | Upper   | Lower              | Upper   |         |       |
| Generating capacity for one unit (MWe)                       | 51.8   | 51.8    | 53.0    | 54.9    | 47.0               | 56.4    | 47.0               | 60.7    | A, B    |       |
| Electricity efficiency, net (%), name plate                  | 23.5   | 23.5    | 24.1    | 25.0    | 21                 | 26      | 21                 | 28      | A, B    |       |
| Electricity efficiency, net (%), annual average              | 22.4   | 22.4    | 22.9    | 23.7    | 19                 | 25      | 19                 | 27      | A, B,C  |       |
| Auxiliary electricity consumption (% of thermal input)       | 2.9  | 2.9     | 2.9     | 2.9     | 2.1                | 3.2     | 1.7                | 3.2     | A, B    |       |
| Cb coefficient (40°C/80°C)                                   | 0.30   | 0.30    | 0.31    | 0.32    | 0.27               | 0.32    | 0.27               | 0.35    | A, B    |       |
| Cv coefficient (40°C/80°C)                                   | 1  | 1       | 1       | 1       | 1                  | 1       | 1                  | 1       | A, B, O |       |
| Forced outage (%)  | 1.0  | 1.0     | 1.0     | 1.0     | 1.0                | 1.0     | 1.0                | 1.0     |         | 1     |
| Planned outage (weeks per year)                              | 2.5  | 2.4     | 2.2     | 1.8     | 2.0                | 2.7     | 1.3                | 2.2     | E       | 1     |
| Technical lifetime (years)                                   | 25   | 25      | 25      | 25      | 20                 | 35      | 20                 | 35      |         | 1     |
| Construction time (years)                                    | 3.0  | 3.0     | 3.0     | 3.0     | 2.5                | 3.5     | 2.0                | 3.5     |         | 1     |
| Space requirement (1000 m2/MWe)                              | 0.8  | 0.8     | 0.8     | 0.7     | 0.7                | 0.9     | 0.5                | 0.9     |         | 1     |
| <b>Regulation ability</b>                                    |  |         |         |         |                    |         |                    |         |         |       |
| Primary regulation (% per 30 seconds)                        | 5.0  | 5.0     | 5.0     | 5.0     | 5.0                | 5.0     | 5.0                | 5.0     | F       |       |
| Secondary regulation (% per minute)                          | 10.0   | 10.0    | 10.0    | 10.0    | 10.0               | 10.0    | 10.0               | 10.0    | F, G    |       |
| Minimum load (% of full load)                                | 20.0   | 20.0    | 20.0    | 20.0    | 20.0               | 20.0    | 20.0               | 20.0    | F, G    |       |
| Warm start-up time (hours)                                   | 0.5  | 0.5     | 0.5     | 0.5     | 0.5                | 0.5     | 0.5                | 0.5     | F, G    |       |
| Cold start-up time (hours)                                   | 2.0  | 2.0     | 2.0     | 2.0     | 2.0                | 2.0     | 2.0                | 2.0     | F, G    |       |
| <b>Environment</b>   |  |         |         |         |                    |         |                    |         |         |       |
| SO <sub>2</sub> (degree of desulphuring, %)                  | 99.8   | 99.8    | 99.8    | 99.8    | 99.0               | 99.9    | 99.5               | 99.9    | H       | 1     |
| NO <sub>x</sub> (g per GJ fuel)                              | 80   | 60      | 20      | 10      | 10                 | 60      | 10                 | 60      | I       | 2;3;5 |
| CH <sub>4</sub> (g per GJ fuel)                              | 0.3  | 0.1     | 0.1     | 0.1     | 0.0                | 0.1     | 0.0                | 0.1     |         | 2     |
| N <sub>2</sub> O (g per GJ fuel)                             | 1.2  | 1.0     | 1.0     | 1.0     | 1.0                | 3.0     | 0.0                | 1.0     | J       | 2     |
| Particles (g per GJ fuel)                                    | 0.3  | 0.3     | 0.3     | 0.3     | 0.1                | 2.0     | 0.1                | 1.0     | J       | 2     |
| <b>Financial data</b>  |  |         |         |         |                    |         |                    |         |         |       |
| Nominal investment (M€/MWe)                                  | 8.0  | 7.8     | 7.4     | 6.5     | 6.6                | 9.1     | 4.7                | 8.0     | N       | 1     |
| - of which equipment   | 4.8  | 4.7     | 4.5     | 4.0     | 4.0                | 5.6     | 2.8                | 4.9     | N       | 1     |
| - of which installation                                      | 3.2  | 3.1     | 2.9     | 2.5     | 2.6                | 3.5     | 1.9                | 3.1     | M       | 1     |
| Fixed O&M (€/MWe/year)                                       | 229,000  | 186,000 | 174,000 | 148,000 | 158,000            | 218,000 | 109,000            | 184,000 | L       | 1     |
| Variable O&M (€/MWh <sub>e</sub> )                           | 25.0   | 25.0    | 24.4    | 23.6    | 21.3               | 28.8    | 17.7               | 29.5    | K       | 1     |
| <b>Technology specific data</b>                              |  |         |         |         |                    |         |                    |         |         |       |
| Steam reheat   | None   | None    | None    | None    | None               | None    | None               | None    |         |       |
| Flue gas condensation  | Yes  | Yes     | Yes     | Yes     | Yes                | Yes     | Yes                | Yes     | D       |       |
| Combustion air humidification                                | No   | No      | No      | No      | No                 | Yes     | No                 | Yes     | D       |       |
| Incineration capacity (Fuel input) (tonnes/h)                | 74.7   | 74.7    | 74.7    | 74.7    | 74.7               | 74.7    | 74.7               | 74.7    | A, B    |       |
| Output of recovered condensate (tonne/MWh <sub>input</sub> ) | 0.11   | 0.11    | 0.11    | 0.12    | 0.10               | 0.14    | 0.10               | 0.15    | D, K    |       |
| Nominal investment (M€/MW fuel input)                        | 1.87   | 1.83    | 1.78    | 1.61    | 1.55               | 2.14    | 1.18               | 2.00    | N       | 1     |
| - of which equipment   | 1.13   | 1.10    | 1.09    | 0.99    | 0.94               | 1.31    | 0.71               | 1.22    | N       | 1     |
| - of which installation                                      | 0.74   | 0.72    | 0.69    | 0.62    | 0.62               | 0.83    | 0.47               | 0.78    | M       | 1     |
| Fixed O&M (€/MW input/year)                                  | 54,000   | 43,900  | 41,900  | 37,000  | 37,300             | 51,300  | 27,100             | 46,000  | L       | 1     |

## 08 WtE CHP and HOP plants

---

|  |      |      |      |      |     |     |     |     |         |     |
|--|------|------|------|------|-----|-----|-----|-----|---------|-----|
| Variable O&M (€/MWh input) *                                   | 5.9  | 5.9  | 5.9  | 5.9  | 5.0 | 6.8 | 4.4 | 7.4 | K       | 1   |
| Nominal investment (€/(tonne/year))                            | 690  | 670  | 650  | 590  | 570 | 790 | 430 | 740 | N       | 1   |
| Fixed O&M (€/tonne)  | 20   | 16   | 15   | 14   | 14  | 19  | 10  | 17  | L       | 1;4 |
| Variable O&M (€/tonne)   | 17   | 17   | 17   | 17   | 15  | 20  | 13  | 22  | K       | 1;4 |
| Heat efficiency, net (%), name plate                           | 79.0 | 79.0 | 78.7 | 78.3 | 74  | 84  | 71  | 86  | A, B    |     |
| Heat efficiency, net (%), annual average                       | 80.2 | 80.2 | 79.9 | 79.6 | 76  | 85  | 73  | 87  | A, B, C |     |
| Additional heat potential with heat pumps (% of thermal input) | 4.2  | 4.2  | 4.0  | 3.7  | 1   | 6   | 1   | 6   | A, B, D |     |

Data sheets WtE CHP, large, 50/100 °C return/forward temperature

| Technology   | Large Waste to Energy CHP, Backpressure turbine, 220 MW feed |         |         |         |                    |         |                    |         |         |       |
|--|--|---------|---------|---------|--------------------|---------|--------------------|---------|---------|-------|
|  | 2015   | 2020    | 2030    | 2050    | Uncertainty (2020) |         | Uncertainty (2050) |         | Note    | Ref   |
| <b>Energy/technical data</b>                                 |  |         |         |         |                    |         |                    |         |         |       |
|  |  |         |         |         | Lower              | Upper   | Lower              | Upper   |         |       |
| Generating capacity for one unit (MWe)                       | 46.8   | 46.8    | 48.2    | 50.1    | 42.1               | 51.6    | 42.1               | 55.9    | A, B    |       |
| Electricity efficiency, net (%), name plate                  | 21.3   | 21.3    | 21.9    | 22.8    | 19                 | 24      | 19                 | 26      | A, B    |       |
| Electricity efficiency, net (%), annual average              | 20.2   | 20.2    | 20.8    | 21.7    | 17                 | 23      | 17                 | 25      | A, B,C  |       |
| Auxiliary electricity consumption (% of thermal input)       | 3.0  | 3.0     | 3.0     | 3.0     | 2.2                | 3.2     | 1.7                | 3.3     | A, B    |       |
| Cb coefficient (50°C/100°C)                                  | 0.28   | 0.28    | 0.29    | 0.30    | 0.25               | 0.31    | 0.25               | 0.34    | A, B    |       |
| Cv coefficient (50°C/100°C)                                  | 1  | 1       | 1       | 1       | 1                  | 1       | 1                  | 1       | A, B, O |       |
| Forced outage (%)  | 1.0  | 1.0     | 1.0     | 1.0     | 1.0                | 1.0     | 1.0                | 1.0     |         | 1     |
| Planned outage (weeks per year)                              | 2.5  | 2.4     | 2.2     | 1.8     | 2.0                | 2.7     | 1.3                | 2.2     | E       | 1     |
| Technical lifetime (years)                                   | 25   | 25      | 25      | 25      | 20                 | 35      | 20                 | 35      |         | 1     |
| Construction time (years)                                    | 3.0  | 3.0     | 3.0     | 3.0     | 2.5                | 3.5     | 2.0                | 3.5     |         | 1     |
| Space requirement (1000 m2/MWe)                              | 0.9  | 0.9     | 0.8     | 0.8     | 0.7                | 1.0     | 0.6                | 1.0     |         | 1     |
| <b>Regulation ability</b>                                    |  |         |         |         |                    |         |                    |         |         |       |
| Primary regulation (% per 30 seconds)                        | 5.0  | 5.0     | 5.0     | 5.0     | 5.0                | 5.0     | 5.0                | 5.0     | F       |       |
| Secondary regulation (% per minute)                          | 10.0   | 10.0    | 10.0    | 10.0    | 10.0               | 10.0    | 10.0               | 10.0    | F, G    |       |
| Minimum load (% of full load)                                | 20.0   | 20.0    | 20.0    | 20.0    | 20.0               | 20.0    | 20.0               | 20.0    | F, G    |       |
| Warm start-up time (hours)                                   | 0.5  | 0.5     | 0.5     | 0.5     | 0.5                | 0.5     | 0.5                | 0.5     | F, G    |       |
| Cold start-up time (hours)                                   | 2.0  | 2.0     | 2.0     | 2.0     | 2.0                | 2.0     | 2.0                | 2.0     | F, G    |       |
| <b>Environment</b>   |  |         |         |         |                    |         |                    |         |         |       |
| SO <sub>2</sub> (degree of desulphuring, %)                  | 99.8   | 99.8    | 99.8    | 99.8    | 99.0               | 99.9    | 99.5               | 99.9    | H       | 1     |
| NO <sub>x</sub> (g per GJ fuel)                              | 80   | 60      | 20      | 10      | 10                 | 60      | 10                 | 60      | I       | 2;3;5 |
| CH <sub>4</sub> (g per GJ fuel)                              | 0.3  | 0.1     | 0.1     | 0.1     | 0.0                | 0.1     | 0.0                | 0.1     |         | 2     |
| N <sub>2</sub> O (g per GJ fuel)                             | 1.2  | 1.0     | 1.0     | 1.0     | 1.0                | 3.0     | 0.0                | 1.0     | J       | 2     |
| Particles (g per GJ fuel)                                    | 0.3  | 0.3     | 0.3     | 0.3     | 0.1                | 2.0     | 0.1                | 1.0     | J       | 2     |
| <b>Financial data</b>  |  |         |         |         |                    |         |                    |         |         |       |
| Nominal investment (M€/MWe)                                  | 8.8  | 8.6     | 8.1     | 7.1     | 7.3                | 10.1    | 5.2                | 8.8     | N       | 1     |
| - of which equipment   | 5.3  | 5.2     | 5.0     | 4.3     | 4.4                | 6.1     | 3.1                | 5.4     | N       | 1     |
| - of which installation                                      | 3.5  | 3.4     | 3.1     | 2.7     | 2.9                | 3.9     | 2.1                | 3.4     | M       | 1     |
| Fixed O&M (€/MWe/year)                                       | 254,000  | 206,000 | 191,000 | 162,000 | 175,000            | 241,000 | 119,000            | 202,000 | L       | 1     |
| Variable O&M (€/MWh <sub>e</sub> )                           | 27.3   | 27.3    | 26.5    | 25.5    | 23.1               | 31.7    | 19.0               | 32.2    | K       | 1     |
| <b>Technology specific data</b>                              |  |         |         |         |                    |         |                    |         |         |       |
| Steam reheat   | None   | None    | None    | None    | None               | None    | None               | None    |         |       |
| Flue gas condensation  | Yes  | Yes     | Yes     | Yes     | Yes                | Yes     | Yes                | Yes     | D       |       |
| Combustion air humidification                                | No   | No      | No      | No      | No                 | Yes     | No                 | Yes     | D       |       |
| Incineration capacity (Fuel input) (tonnes/h)                | 74.7   | 74.7    | 74.7    | 74.7    | 74.7               | 74.7    | 74.7               | 74.7    | A, B    |       |
| Output of recovered condensate (tonne/MWh <sub>input</sub> ) | 0.03   | 0.03    | 0.04    | 0.05    | 0.01               | 0.11    | 0.01               | 0.11    | D, K    |       |
| Nominal investment (M€/MW fuel input)                        | 1.87   | 1.83    | 1.78    | 1.61    | 1.55               | 2.14    | 1.18               | 2.00    | N       | 1     |
| - of which equipment   | 1.13   | 1.10    | 1.09    | 0.99    | 0.94               | 1.31    | 0.71               | 1.22    | N       | 1     |
| - of which installation                                      | 0.74   | 0.72    | 0.69    | 0.62    | 0.62               | 0.83    | 0.47               | 0.78    | M       | 1     |
| Fixed O&M (€/MW input/year)                                  | 54,000   | 43,900  | 41,900  | 37,000  | 37,300             | 51,300  | 27,100             | 46,000  | L       | 1     |
| Variable O&M (€/MWh input) *                                 | 5.8  | 5.8     | 5.8     | 5.8     | 4.9                | 6.7     | 4.3                | 7.3     | K       | 1     |



|  |      |      |      |      |     |     |     |     |         |     |
|--|------|------|------|------|-----|-----|-----|-----|---------|-----|
| Nominal investment (€/tonne/year)                              | 690  | 670  | 650  | 590  | 570 | 790 | 430 | 740 | N       | 1   |
| Fixed O&M (€/tonne)  | 20   | 16   | 15   | 14   | 14  | 19  | 10  | 17  | L       | 1;4 |
| Variable O&M (€/tonne)   | 17   | 17   | 17   | 17   | 14  | 20  | 13  | 22  | K       | 1;4 |
| Heat efficiency, net (%), name plate                           | 75.3 | 75.3 | 75.1 | 75.1 | 70  | 84  | 68  | 85  | A, B    |     |
| Heat efficiency, net (%), annual average                       | 76.3 | 76.3 | 76.2 | 76.3 | 72  | 85  | 70  | 86  | A, B, C |     |
| Additional heat potential with heat pumps (% of thermal input) | 10.0 | 10.0 | 9.7  | 9.0  | 4   | 12  | 4   | 12  | A, B, D |     |

## Notes:

### Notes common for all the waste CHP data sheets

- A Assumed lower heating value 10.6 MJ/kg, waste input at the listed incineration capacity, which is divided in two, equally sized furnace/boiler units in case of CHP large. One turbine/generator set is foreseen. Live steam pressure in base case 50 bara, temperature 425 °C of 2015 and 2020, increasing to 440 °C and 450 °C, in 2030 and 2050, respectively. Efficiencies refer to lower heating value.
- B With flue gas condensation (condensation through heat exchange with DH-water, only) and a backpressure turbine/condenser system optimised for DH return temperature 40°C and flow 80°C, except the CHP large case with temperature set 50/100°C.
- C Annual average heat output is higher than nameplate because the total efficiency is constant, and the annual average electricity generation is lower than nameplate electricity output. The parasitic electricity consumption has been subtracted in the listed electricity efficiencies.
- D Additional heat potential for heat pump is the flue gas condensation potential remaining after the direct condensation stage (condensation by heat exchange with DH-water). Direct condensation is included in all cases, and combustion air humidification is included in lower/upper ranges of 2020 and 2050.
- E Focus on availability and ambitions of 2 years' continuous operation is expected to gradually reduce planned outage.
- F Regulation and start-up refer to electricity generation controlled by the turbine operation. The WtE facility would usually be operating at 100% thermal input, and the electricity output is controlled to the desired level by use of turbine by-pass, by which excess steam is used to produce DH-energy. Warm start-up time refers to 2 days down-time of the turbine.
- G The combustion process and boiler may be regulated approx. 1% per minute considering extensive use of inconell (in stead of refractory, which may limit rate of change to 0.5% per minute). Minimum load is typically 70% of thermal input under which limit it may be difficult to comply with the requirement of min. 2 sec residence time of the flue gas at min. 850 °C after the last air injection. Below this limit it may also be a challenge to ensure sufficient superheating of the steam. Warm start-up of the combustion process is typically 8 hours and cold start-up is 8 hours.
- H Assumed low SO<sub>2</sub>-emission 1 g/GJ in 2015 considering the use of flue gas condensation by wet scrubbing down-stream the flue gas treatment system. Sulphur content in fuel 270 g/GJ.
- I Increased focus on NO<sub>x</sub> reduction is expected in the future, requiring use of SNCR technology to its utmost potential by 2030 (at 60 g/GJ) and use of the more effective catalytic SCR-technology by 2050. The SCR-technology entails additional investment.
- J N<sub>2</sub>O is expected to be related primarily to the use of SNCR using urea injection. This is why little N<sub>2</sub>O is expected when the SCR-deNO<sub>x</sub> technology is used (indicated by very low NO<sub>x</sub>-level).
- K Variable O&M cost includes consumables (for FGT etc.), disposal of residues, small share of staff-cost and maintenance cost. Cost for disposal of recovered flue gas condensate is included at a rate of 1.0 €/tonne of condensate. Electricity consumption is not included for CHP, and revenues from sale of electricity and heat are not included. Taxes are not included.
- L Fixed O&M include amongst other things the major part of staffing and maintenance, analyses, research and development, accounting, insurances, fees, memberships, office. Not included are finance cost, depreciation and amortisation.

M Installation includes civils works (including waste bunker) and project cost considering LOT-based tendering.

N Assuming LOT-based tendering of electromechanical equipment. EPC contracting is expected at unchanged or slightly higher cost (0-10%), provided only construction is included in the EPC contract.

## References

### References common for all the waste CHP data sheet

- 1 Rambøll present work, range of WtE-projects
- 2 Emission factors of 2006: 102 g/GJ NO<sub>x</sub>, <8,3 g/GJ for SO<sub>2</sub>, <0,34 g/GJ for CH<sub>4</sub>, 1,2 g/GJ for N<sub>2</sub>O, cf. Nielsen, M., Nielsen, O.-K. & Thomsen, M. 2010: Emissions from decentralised CHP plants 2007 - Energinet.dk Environmental project no. 07/1882. Project report 5 – Emission factors and emission inventory for decentralised CHP production. National Environmental Research Institute, Aarhus University. 113 pp. – NERI Technical report No. 786.  
<http://www.dmu.dk/Pub/FR786.pdf>
- 3 Environmental permit of a new WtE-facility includes NO<sub>x</sub> limit value of 180 mg/Nm<sup>3</sup> =100 g/GJ. Operation is expected well below limit value. Cf. Miljøstyrelsen, "Tillæg til miljøgodkendelse, Ny ovnlinje 5 på Nordforbrænding, Juni 2013,"  
<http://mst.dk/media/mst/Attachments/Tillgtilmiljogodkendelseovn5Juni2013.pdf>
- 4 Two scenarios for adaptation of the waste incineration capacity in Denmark (in Danish: To scenarier for tilpasning af affaldsforbrændingskapaciteten i Danmark.) EA Energianalyse 2014.
- 5 Best Available Techniques (BAT), Reference Document for Waste Incineration. Frederik Neuwahl, Gianluca Cusano, Jorge Gómez Benavides, Simon Holbrook,  
Serge Roudier; Best Available Techniques (BAT) Reference Document for Waste Incineration; EUR 29971 EN; doi:10.2760/761437, DEC 2019  
[https://eippcb.jrc.ec.europa.eu/reference/BREF/WI/JRC118637\\_WI\\_Bref\\_2019\\_published.pdf](https://eippcb.jrc.ec.europa.eu/reference/BREF/WI/JRC118637_WI_Bref_2019_published.pdf)

Data sheets: Waste, HOP

| Technology   | Waste to Energy, DH only, 35 MW feed |        |        |        |                    |        |                    |        |         |       |
|--|--------------------------------------|--------|--------|--------|--------------------|--------|--------------------|--------|---------|-------|
|  | 2015                                 | 2020   | 2030   | 2050   | Uncertainty (2020) |        | Uncertainty (2050) |        | Note    | Ref   |
| <b>Energy/technical data</b>                             |                                      |        |        |        |                    |        |                    |        |         |       |
|  |                                      |        |        |        | Lower              | Upper  | Lower              | Upper  |         |       |
| Heat generation capacity for one unit (MW)               | 36.9                                 | 36.9   | 37.0   | 37.2   | 36.3               | 37.9   | 36.3               | 38.1   | A, B    |       |
| Total heat efficiency, net (%), ref. LHV, name plate     | 105.6                                | 105.6  | 105.8  | 106.3  | 103                | 109    | 103                | 109    | A, B, C |       |
| Total heat efficiency, net (%), ref. LHV, annual average | 105.6                                | 105.6  | 105.8  | 106.3  | 103                | 109    | 103                | 109    | A, B, C |       |
| Auxiliary electricity consumption (% of heat gen)        | 2.6                                  | 2.6    | 2.6    | 2.5    | 1.9                | 2.8    | 1.5                | 2.8    | A, B, C |       |
| Forced outage (%)  | 1                                    | 1      | 1      | 1      | 1                  | 1      | 1                  | 1      |         | 1     |
| Planned outage (weeks per year)                          | 3.0                                  | 2.9    | 2.6    | 2.1    | 2.4                | 3.3    | 1.6                | 2.6    | E       | 1     |
| Technical lifetime (years)                               | 25                                   | 25     | 25     | 25     | 20                 | 35     | 20                 | 35     |         | 1     |
| Construction time (years)                                | 2                                    | 2      | 2      | 2      | 1.5                | 2.5    | 1.5                | 2.5    |         | 1     |
| Space requirement (1000 m2/MWth heat output)             | 0.54                                 | 0.54   | 0.54   | 0.54   | 0.46               | 0.62   | 0.40               | 0.67   |         | 1     |
| <b>Regulation ability</b>                                |                                      |        |        |        |                    |        |                    |        |         |       |
| Primary regulation (% per 30 seconds)                    | NA                                   | NA     | NA     | NA     | NA                 | NA     | NA                 | NA     |         |       |
| Secondary regulation (% per minute)                      | 1                                    | 1      | 1      | 1      | 1                  | 1      | 1                  | 1      | G       |       |
| Minimum load (% of full load)                            | 70                                   | 70     | 70     | 70     | 70                 | 70     | 70                 | 70     | G       |       |
| Warm start-up time (hours)                               | 8                                    | 8      | 8      | 8      | 8                  | 8      | 8                  | 8      | G       |       |
| Cold start-up time (hours)                               | 12                                   | 12     | 12     | 12     | 12                 | 12     | 12                 | 12     | G       |       |
| <b>Environment</b>                                       |                                      |        |        |        |                    |        |                    |        |         |       |
| SO <sub>2</sub> (degree of desulphuring, %)              | 99.8                                 | 99.8   | 99.8   | 99.8   | 99.0               | 99.9   | 99.5               | 99.9   | H       | 1     |
| NO <sub>x</sub> (g per GJ fuel)                          | 80                                   | 60     | 40     | 20     | 10                 | 60     | 10                 | 60     | I       | 2;3;5 |
| CH <sub>4</sub> (g per GJ fuel)                          | 0.3                                  | 0.1    | 0.1    | 0.1    | 0                  | 0.1    | 0                  | 0.1    |         | 2     |
| N <sub>2</sub> O (g per GJ fuel)                         | 1                                    | 1      | 1      | 1      | 1                  | 3      | 0                  | 1      | J       | 2     |
| Particles (g per GJ fuel)                                | 0.3                                  | 0.3    | 0.3    | 0.3    | 0.1                | 2      | 0.1                | 1      | J       | 2     |
| <b>Financial data</b>                                    |                                      |        |        |        |                    |        |                    |        |         |       |
| Nominal investment (M€/MWth - heat output)               | 1.78                                 | 1.74   | 1.71   | 1.54   | 1.52               | 2.11   | 1.23               | 2.11   | P       |       |
| - of which equipment                                     | 1.02                                 | 1.00   | 1.00   | 0.91   | 0.87               | 1.23   | 0.71               | 1.23   | P       |       |
| - of which installation                                  | 0.76                                 | 0.74   | 0.70   | 0.63   | 0.65               | 0.87   | 0.53               | 0.88   | P       |       |
| Fixed O&M (€/MWth/year), heat output                     | 80,700                               | 78,000 | 73,900 | 64,700 | 66,800             | 91,500 | 49,400             | 83,500 | P       |       |
| Variable O&M (€/MWh) heat output                         | 7.2                                  | 7.4    | 8.2    | 8.5    | 6.3                | 8.4    | 6.9                | 10.2   | K, P    |       |
| - of which is electricity costs (€/MWh-heat)             | 1.6                                  | 1.8    | 2.6    | 2.9    | 1.7                | 1.8    | 2.8                | 3.1    | K, P    |       |
| - of which is other O&M costs (€/MWh-heat)               | 5.6                                  | 5.6    | 5.6    | 5.6    | 4.6                | 6.6    | 4.1                | 7.1    | K, P    |       |
| <b>Technology specific data</b>                          |                                      |        |        |        |                    |        |                    |        |         |       |
| Flue gas condensation                                    | Yes                                  | Yes    | Yes    | Yes    | Yes                | Yes    | Yes                | Yes    | D       |       |
| Combustion air humidification                            | No                                   | No     | No     | No     | No                 | Yes    | No                 | Yes    | D       |       |
| Output of recovered condensate (tonne/MWh_input)         | 0.13                                 | 0.13   | 0.14   | 0.14   | 0.12               | 0.17   | 0.12               | 0.17   | D, K    |       |
| Incineration capacity (Fuel input) (tonnes/h)            | 11.9                                 | 11.9   | 11.9   | 11.9   | 11.9               | 11.9   | 11.9               | 11.9   | A, B    |       |
| Nominal investment (M€/MW fuel input)                    | 1.88                                 | 1.84   | 1.81   | 1.64   | 1.60               | 2.22   | 1.31               | 2.24   | N       | 1     |
| - of which equipment                                     | 1.08                                 | 1.05   | 1.06   | 0.97   | 0.92               | 1.30   | 0.75               | 1.31   | N       | 1     |
| - of which installation                                  | 0.80                                 | 0.78   | 0.74   | 0.67   | 0.68               | 0.92   | 0.56               | 0.93   | M       | 1     |
| Fixed O&M (€/MW input/year)                              | 85,200                               | 82,300 | 78,200 | 68,800 | 70,500             | 96,600 | 52,600             | 88,800 | L       | 1     |
| Variable O&M including electricity (€/MWh input)         | 7.6                                  | 7.8    | 8.6    | 9.0    | 6.8                | 8.7    | 7.5                | 10.6   | K       | 1     |
| Nominal investment (€/(tonne/year))                      | 690                                  | 680    | 660    | 600    | 590                | 820    | 480                | 830    | N       | 1     |

## 08 WtE CHP and HOP plants

---

|  |      |      |      |      |      |      |      |      |         |     |
|--|------|------|------|------|------|------|------|------|---------|-----|
| Fixed O&M (€/tonne)  | 31   | 30   | 29   | 25   | 26   | 36   | 19   | 33   | L       | 1;4 |
| Variable O&M (€/tonne)   | 22.5 | 22.9 | 25.4 | 26.5 | 20.2 | 25.6 | 22.0 | 31.2 | K       | 1;4 |
| - of which electricity costs (€/tonne)                         | 5.1  | 5.5  | 8.0  | 9.1  | 5.3  | 5.5  | 8.9  | 9.4  | K       | 1;4 |
| - of which other O&M costs (€/tonne)                           | 17.4 | 17.4 | 17.4 | 17.4 | 14.8 | 20.0 | 13.1 | 21.8 | K       | 1;4 |
| Additional heat potential with heat pumps (% of thermal input) | 4.2  | 4.2  | 4.0  | 3.7  | 1    | 6    | 1    | 6    | A, B, D |     |

**Notes:**

- A Assumed lower heating value 10.6 MJ/kg, waste input 11.9 tph = tonnes per hour (incineration capacity), corresponding to thermal input of 35 MW. Efficiencies refer to lower heating value.
- B With flue gas condensation (condensation through heat exchange with DH-water, only), DH return temperature 40°C and flow 80°C
- C The stated total efficiency does NOT consider auxiliary electricity consumption. It describes the total net amount of heat produced at the plant. This is contrary to CHP where the auxiliary electricity is subtracted from the production to yield the net electricity efficiency. Instead the cost of auxiliary electricity consumption is included in variable O&M.
- D Additional heat potential for heat pump is the flue gas condensation potential remaining after the direct condensation stage (condensation by heat exchange with DH-water). Direct condensation is included in all cases, and combustion air humidification is included in lower/upper ranges of 2020 and 2050.
- E Focus on availability and ambitions of 2 years' continuous operation is expected to gradually reduce planned outage.
- F Deleted.
- G The combustion process and boiler may be regulated approx. 1% per minute considering extensive use of inconell (instead of refractory, which may limit rate of change to 0.5% per minute). Minimum load is typically 70% of thermal input under which limit it may be difficult to comply with the requirement of min. 2 sec residence time of the flue gas at min. 850 °C after the last air injection. Below this limit it may also be a challenge to ensure sufficient superheating of the steam. Warm start-up of the combustion process is typically 8 hours and cold start-up is 8 hours.
- H Assumed low SO<sub>2</sub>-emission 1 g/GJ in 2015 considering the use of flue gas condensation by wet scrubbing down-stream the flue gas treatment system. Sulphur content in fuel 270 g/GJ
- I Increased focus on NO<sub>x</sub> reduction is expected in the future, requiring use of SNCR technology to its utmost potential by 2030 (at 60 g/GJ) and use of the more effective catalytic SCR-technology by 2050. The SCR-technology entails additional investment.
- J N<sub>2</sub>O is expected to be related primarily to the use of SNCR using urea injection. This is why little N<sub>2</sub>O is expected when the SCR-deNO<sub>x</sub> technology is used (indicated by very low NO<sub>x</sub>-level).
- K Variable O&M cost includes consumables (for FGT etc.), disposal of residues, small share of staff-cost and maintenance cost. Electricity consumption is included for DH and associated cost listed separately, in addition. Cost for disposal of recovered flue gas condensate is included at a rate of 1.0 €/tonne of condensate. Revenues from sale of heat are not included. Taxes are not included. The cost of auxiliary electricity consumption is calculated using the following electricity prices in €/MWh: 2015: 63, 2020: 69, 2030: 101, 2050: 117. These prices include production costs and transport tariffs, but not any taxes or subsidies for renewable energy.
- L Fixed O&M include amongst other things the major part of staffing and maintenance, analyses, research and development, accounting, insurances, fees, memberships, office. Not included are finance cost, depreciation and amortisation.
- M Installation includes civils works (including waste bunker) and project cost considering LOT-based tendering
- N Assuming LOT-based tendering of electromechanic equipment
- P Reference to heat output because of the lack of electricity production

**References**

- 1 Rambøll present work, range of WtE-projects
- 2 Emission factors of 2006: 102 g/GJ NO<sub>x</sub>, <8,3 g/GJ for SO<sub>2</sub>, <0,34 g/GJ for CH<sub>4</sub>, 1,2 g/GJ for N<sub>2</sub>O, cf. Nielsen, M., Nielsen, O.-K. & Thomsen, M. 2010: Emissions from decentralised CHP plants 2007 - Energinet.dk Environmental project no. 07/1882. Project report 5 – Emission factors and emission inventory for decentralised CHP production. National Environmental Research Institute, Aarhus University. 113 pp. – NERI Technical report No. 786.  
<http://www.dmu.dk/Pub/FR786.pdf>.
- 3 Environmental permit of a new WtE-facility includes NO<sub>x</sub> limit value of 180 mg/Nm<sup>3</sup> =100 g/GJ. Operation is expected well below limit value. Cf. Miljøstyrelsen, "Tillæg til miljøgodkendelse, Ny ovnlinje 5 på Nordforbrænding, Juni 2013,"

<http://mst.dk/media/mst/Attachments/Tilgtilmiljogodkendelseovn5Juni2013.pdf>

- 4 Two scenarios for adaptation of the waste incineration capacity in Denmark (in Danish: To scenarier for tilpasning af affaldsforbrændingskapaciteten i Danmark.) EA Energianalyse 2014.
- 5 Best Available Techniques (BAT), Reference Document for Waste Incineration. Frederik Neuwahl, Gianluca Cusano, Jorge Gómez Benavides, Simon Holbrook,

Serge Roudier; Best Available Techniques (BAT) Reference Document for Waste Incineration; EUR 29971 EN; doi:10.2760/761437, DEC 2019

[https://eippcb.jrc.ec.europa.eu/reference/BREF/WI/JRC118637\\_WI\\_Bref\\_2019\\_published.pdf](https://eippcb.jrc.ec.europa.eu/reference/BREF/WI/JRC118637_WI_Bref_2019_published.pdf)

## 09 Biomass CHP and HOP plants

### Contact information

Danish Energy Agency: Jacob Hjerrild Zeuthen/Filip Gamborg

Author: Rambøll: Tore Hulgaard, Claus Hindsgaul, Niels Houbak, Søren Hallberg Olsen

### Publication date

March 2018

### Amendments after publication date

| Date           | Ref.                   | Description  |
|----------------|------------------------|--|
| March 2020     | 09 Biomass section     | Medium and Large scale wood chips boilers added.<br>Text revised to incorporate new larger boilers.<br>Revision of ash-content and lower heating value for wood chips.   |
| January 2020   | 09 Biomass CHP and HOP | Revised qualitative- and quantitative description. Among adjustments in datasheets are efficiencies, distribution between variable and fixed O&M and notes<br><br>Addition of 50/100 °C datasheets for large backpressure units<br><br>Addition of extraction units in qualitative- and quantitative description |
| March 19       | 09 Biomass CHP and HOP | Datasheets added for large WtE and biomass backpressure CHP's with a temperature set of 50 °C/100 °C in addition to existing datasheets for 40 °C/80 °C<br><br>Sheets for extraction plants are incorporated   |
| September 2018 | 09 Biomass CHP and HOP | Updated qualitative description and merging of CHP and HOP descriptions  |

## Qualitative description

### Brief technology description

Energy conversion in CHP or HOP (Heat Only Plant) of biomass is the combustion of wood-chips from forestry and/or from wood industry, wood pellets or straw. The main technical differences between the two are the electricity production, which is produced in a CHP but not a HOP, and the resulting necessary operating temperatures.

CHP production from biomass has been used in an increasing scale for many years in Denmark utilizing different technologies. The typical implementation is combustion in a biomass boiler feeding a steam turbine. The energy output from the boiler is either hot water to be used directly for district heating or it could be (high pressure) steam to be expanded through a turbine. The turbine is either a backpressure – or an extraction turbine. In the backpressure turbine, the expansion ends in the district heat condensers at a pressure at app. 0.4 bara, in the extraction unit the expansion is extended to the lowest possible pressure app. 0.025 bara, which is provided by a water-cooled condenser. The extraction unit is capable of running both in backpressure and condensing mode as well as every combination in between.

Application of flue gas condensation for further energy recovery is customary at biomass fired boilers using feedstock with high moisture content, e.g. wood chip, except at small plants below 1 - 2 MW<sub>th input</sub> due to the additional capital and O&M costs. Plants without flue gas condensation are typically designed for other biomass fuels with less than 30% moisture content.

Flue gas condensation is however available also for straw firing. The flue gas condensation may raise the efficiency with around 10%-points according to model calculations (at 40°C DH return temperature), representing advances in condensation efficiency and return temperature compared with previous indications of 5-10%. Currently in Denmark only a few straw-fired plants are equipped with flue gas condensation.

Straw-fired boilers are normally equipped with a bag filter for flue gas cleaning. Electro filters do not work as efficiently with straw firing as they do with wood firing due to deposits formed by salts in the straw.

Straw fired plants should be equipped with heat accumulation tanks due to their disability to produce at less than 40% of full load, as described under the section "Regulation ability".

### ORC plant

An alternative type of plant is the organic Rankine cycle plants (ORC plants). In this the (biomass-) boiler is used for heating (no evaporation) thermal oil to slightly above 300°C. This heated oil transfers the heat to an ORC plant which is similar to a steam cycle but it uses a refrigerant instead of water as working media.

The reason for an interest in ORC plants is that such equipment is delivered in standardized complete modules at an attractive price and in combination with 'a boiler' that only is used for heating oil, the investment is relatively modest.

The ORC technology is a waste heat recovery technology developed for low temperature and low-pressure power generation. The ORC unit is a factory assembled module – this makes them less flexible but cheap. This may make it financially attractive to build small scale CHP facilities. The 'Rankine' part indicates that it is a technology with similarities to water-steam (Rankine) based systems. The main difference being the use of a media i.e. a refrigerant or silicone oil (an organic compound that can burn but does not explode) with thermodynamic properties that makes it more adequate than water for low temperature power generation.

Common technology description for biomass and WtE is found in chapter "*Introduction to Waste and Biomass Plants*". Also, flue gas condensation, combustion air humidification, fuels and an improved energy model for technology data are described there.

### **Input**

The fuel input to biomass plants can in general be described as biomass; e.g. residues from wood industries, wood chips (from forestry), straw and energy crops. Combustion can in general be applied for biomass feedstock with average moisture contents up to 60% for wood chips and up to 25% for straw dependent on combustion technology. The three types of biomass feedstock considered here are: Wood chips, wood pellets (white pellets), and straw. They are in several ways very different (humidity, granularity, ash content and composition, grindability, and density).

Sometimes it is possible to change fuel at a plant from one type of biomass to another, but it should be explicitly guaranteed by the supplier of the plant. Below is a broad description of biomass fuels.

Wood (particularly in the form of chips) is usually the most favourable biomass for combustion due to its low content of ash, nitrogen and alkaline metals, however typically with 45 % moisture for chips and below 10% for pellets. Herbaceous biomass like straw, miscanthus and other annual/fast growing crops have higher contents of K, N, Cl, S etc. that lead to higher primary emissions of NO<sub>x</sub> and particulates, increased ash generation, corrosion rates and slag deposits.



The amount of biomass available for energy production varies over time. From 2006 to 2014, the Danish straw production varied between 5.2 and 6.3 million tonnes per year (avg. 5.6 mil. t.), while the amount used for energy varied between 1.4 and 2 million tonnes (avg. 1.6 mil. t.).

Other exotic biomasses as empty fruit bunch pellets (EFB) and palm kernel shells (PKS) are available in the market; however, operating experience seems to be limited.

Forest residues are typically delivered as wood chips. Forest residues may also be delivered as pellets. During pellet production the fuel is dried to moisture content below 10%. As of today, the use of forest biomass for energy purposes accounts for only a small percentage of the total forest biomass production for, say, timber, paper, and other industrial purposes; thus, typically biomass for energy purposes is (and must be) a residual product. This is also reflected by the fact that the current price per GJ for wood products for energy purposes is much lower than the price for industrial applications of wood. Further to this there seems to be a growing interest for utilizing other types of surplus biomass from industrial productions like Vinery, olive oil production, sugar production, and more.

Wood chips are wood pieces of 5-50 mm in the fibre direction, longer twigs (slivers), and a fine fraction (fines). The quality description is based on three types of wood chips: Fine, coarse, and extra coarse. The names refer to the size distribution only, not to the quality. Fine particles as well as thin, long fibres may cause problems (in case the boiler is using grate firing). In the table below can be seen some typical (commercial) requirements for wood chips.

Typical sizes in a sample (refer also to EN ISO 17225-1):

| Name         | Withhold on sieve | Share w%       |
|--------------|-------------------|----------------|
| Fines        | <3 mm             | <12            |
| Small        | 3 < X < 8 mm      | <25            |
| Coarse       | 8 < X < 16 mm     | No requirement |
| Extra coarse | 16 < X < 45 mm    | No requirement |
| Over size    | 45 < X < 63 mm    | < 3            |
| Over long 10 | > 63 mm           | < 6            |
| Over long 20 | 100-200 mm long   | < 1.5          |

**Table 5** General terms and commercial requirements for wood chips

Ash concentrations must not exceed 2% on dry basis.

Existing CHP and HOP boilers in Denmark can burn wood-chips with up to 45-63% moisture content, depending on technology. In 2014-2015, the actual moisture content was 40% in average, varying between 25 and 55% [1]. Wood chips with high moisture content will often be mixed with dry wood chips. Smaller units use grate firing technology when firing wood chips, while some larger units uses a Circulating Fluidized Bed (CFB) or Bubbling Fluidized Bed (BFB) boiler technology.

Other possible fuels are chipped energy crops (e.g. willow and poplar) and chipped park and garden waste. The fuel quality must be in focus. Small particles must be avoided as well as long thin pieces. High moisture content of e.g. willow will increase the level of CO and PAH, so either the willow must be low in moisture content or it must be mixed with other fuels. Willow is known to take up Cadmium from the soil and thus increasing the concentrations in ash. The amount of cadmium up take is depending on where the willow is grown. Poplar has been found to give problems in the boiler like "popcorn" in a combustion test. Chipped Park and garden waste must be of a good quality with low content

of non-combustible materials, because of risks of blocking the grate [1]. Impurities as plastic can classify the fuel as waste resulting in taxation of all the fuel. Difficult biomass residues are therefore often utilized in WtE facilities having available capacity.

Wood pellets are made from wood chips, sawdust, wood shavings and other residues from sawmills and other wood manufacturers. Pellets are produced in several types and grades as fuels for electric power plants and DH (low grade), and homes (high grade). Pellets are extremely dense (up to the double of the density of the basic material) and can be produced with a low humidity content (below 5% for high grade products) that allows easy handling (incl. long-term storage) and to be burned with high combustion efficiencies. When humidified, pellets are prone to auto-ignition. When exposed to mechanical treatment like conveyer transportation the pellets may break (or disintegrate) and release dust; this dust is highly explosive and therefore constitute a serious hazard. Danish plants using wood pellets or –chips must ensure the sustainability of the fuel. Both the disintegration of wood chips in hammer mills and the subsequent drying require energy and this must come from non-fossil sources (e.g. the wood itself). Wood pellets are fired in larger CHP's with modified coal burners and mills. Coal ash is generally cofired with wood pellets by adding an amount of around 5% of the feed in order to absorb alkali metals and sulfur from the flue gas. Coal ash has a good effect on minimising the slagging and fouling tendency as well as on the SCR catalyst efficiency and lifetime.

Straw is a by-product from the growing of commercial crops, in North Europe primarily cereal grain, rape and other seed-producing crops. Straw is often delivered as big rectangular bales (Hesston bales), typically approx. 500-750 kg each, or MIDI bales (400-800 kg each) from storages at the farms to the DH plants etc. during the year pursuant to concluded straw delivery contracts. MIDI bales are smaller, so transportation can be with 3 layers. However, the density is higher. Not all plants have a system to handle these bales.

### Output

The products from biomass CHP plants are electricity and heat as steam, hot (> 110°C) or warm (< 110°C) water as district heat.

The output from biomass HOP is hot water for district heat or low-pressure steam for industrial purposes. The total energy efficiency is identical for heat and CHP plants, except that some minor heat losses in the generator and turbine gearbox of the CHP plant are avoided. The heat production from a HOP is thus identical (or slightly higher) than the sum of produced electricity and heat from an equivalent CHP plant.

In case of flue gas condensation, excess condensate may be upgraded to high quality water useful for technical purposes such as boiler water or for covering water losses of the district-heating network.

### Typical capacities

|                   |  |
|-------------------|--|
| Large scale CHP:  | > 100 MW <sub>th input</sub> (~>25 MW <sub>e</sub> )     |
| Medium scale CHP: | 25 - 100 MW <sub>th input</sub> (~6-25 MW <sub>e</sub> ) |
| Small scale CHP:  | 1 – 25 MW <sub>th input</sub> (~0.1-6 MW <sub>e</sub> )  |

The size classification for CHP's has been changed from previous editions of the catalogue. The boundary between small and medium-sized plants of 25 MW<sub>th input</sub> is selected based on the suppliers' experience<sup>9</sup>. Large scale CHP may be constructed up to around 1000 MW<sub>th input</sub>, and possibly even larger.

<sup>9</sup> This classification does not correspond to the classification according to EU's IE-Directive which operates with medium size (1-50 MW<sub>th input</sub>) and large size (≥50 MW<sub>th input</sub>) combustion plants

The capacities of CHP's supplying heat to district heating systems are primarily determined by the heat demands. Most plants are equipped with a facility to by-pass the turbine temporarily to increase the heat production at the expense of losing the electricity production; the by-pass is in use more often than it was 10-20 years ago.

For biomass HOP's the typical capacities are 1 - 50 MW<sub>th input</sub>. The majority of district heating plants are below 15 MW<sub>th input</sub> with an average size of 5-6 MW<sub>th input</sub> dependent of the fuel [11].

### Regulation ability and other power system services

The CHP's can operate in a large range (20% to 100% for once-through suspension fired boilers). Biomass plants with drum type boilers (typical for grate fired boilers) can be operated in the range from 40-100% load. The lower end of the range is defined by the ability to generate super-heated steam at the required temperature to operate the turbine and obtain reasonable electricity efficiency. For heat production only, the boiler could go to lower load. The CHP-range is likely to broaden slightly in the future, but the technology appears to have limitations.

Large plants may be designed for optional operation in pure electrical mode (condensing mode) with slightly higher electrical efficiency but without heat production. The condensing ability is mainly seen in large plants over 130 MW<sub>th input</sub> and primarily used today for large Pulverized Fuel (PF) plants.

CHP's, with and without extraction, are capable of supplying both primary and secondary load support. Though somewhat slower than coalfired PF plants of comparable sizes.

Typical wood fired HOP's are regulated 25-100% of full capacity, without violating emission standards. The best technologies can be regulated 10-120% with fuel not exceeding 35% moisture content.

Straw fired HOP's should not be operated below approx. 40% of full load due to emission standards. Straw fired plants should accordingly be equipped with a heat accumulating tank allowing for optimal operational conditions.

### Advantages/disadvantages

Extraction units have the possibility to optimize the power-production when the market calls for it i.e. when the power prize is high. Additional power can be produced, especially in the warmer periods when the need for heat is low.

Some biomass resources, in particular straw, contain highly corrosive components such as chlorine which together with potassium forms deposits that are both corrosive and limits heat uptake. In order to avoid or reduce the risk of slagging and corrosion, boiler manufacturers have traditionally abstained from using similar steam pressure/temperatures in biomass-fired plants as in coal-fired plants. However, advances in materials and boiler design have enabled the newest plants to deliver fairly high steam data and power efficiencies. Straw fired boilers can be operated up to 540°C and wood fired boilers up to slightly above 560°C. In most cases the technical limits are somewhat above what is economically feasible. The availability of suited steam turbines might limit the steam temperature for smaller sized plants.

### Space requirements

Generally, in this chapter, all the investigated biomass plants are designed and priced with a small fuel storage facility. Typically, it is sized to last for two days of full load operation. The size of the storage has for some fuels a major impact on the totally required space (area) and it also can have a serious impact on the total CAPEX; to avoid this influence the store is kept small. In order to calculate CAPEX for a different size of the store, the tables contain an entry called 'Fuel storage specific cost in excess of 2 days (M€/MW<sub>th input</sub>/storage day) for biomass fuels.

The area to be used for the buildings containing the process equipment is estimated in various ways. Very little additional area is added, say for administration, canteen, garages, work shop, etc. independent of the size of the plant. Further to this, some additional area to be used for other fuel handling, manoeuvring and weighing of trucks, parking of vehicles, roads and other free area. In total, it is ensured to have a reasonable percentage of area usage.

The largest plants (wood chips and pellets) are so large that a harbour facility is most appropriate, which is a significant cost addition. This element is not included neither in space requirements nor in cost in the data tables. Other infrastructure facilities like a railroad for fuel transport are not considered.

Extraction units will, compared to backpressure units, require additional space for extra heaters, condenser and cooling-water channels and/or pipes.

### Environment

The main ecological footprints from biomass combustion are persistent toxicity, climate change (GHG potential), and acidification. However, the footprints are considered small [1]. It is, however, an area of both major concern and discussion. Further to this is also added a concern on the sustainability of using in particular wood-like biomasses for power production. It is not the intent of this catalogue to initiate such a discussion but merely to mention that biomass fuelled plants can reduce GHG emissions considerably compared to fossil fuel fired plants, but it is still discussed if it resource-wise globally is a viable long term solution.

Modern flue gas cleaning systems will typically include the following processes: DeNO<sub>x</sub> - ammonia injection (SNCR) or catalytic (SCR), SO<sub>2</sub> capture by injection of lime or the use of another SO<sub>2</sub> absorbing system, dust abatement by bag house filters.

NO<sub>x</sub> emissions may be reduced, by about 60-70%, by selective non-catalytic reduction (SNCR) on wood chips fired boilers and 30-40% on straw fired boilers. NO<sub>x</sub> emission may be reduced by 80-90% by selective catalyst (SCR). SNCR is a relatively low-cost solution but it is not necessarily applicable for a boiler subject to large load variations and constructed with high cooling rates and super heaters in the area most suitable for ammonia injection. The SCR solution requires installation of a catalyst which can be either a high temperature location near or in the boiler (downstream a particle filter) or it could be a much more expensive tail-end solution requiring re-heat of the flue gas. For fuels with high alkali-metal concentrations (mainly potassium) tail end solution is preferred to avoid poisoning of the catalyst that could quickly reduce its activity, however some plants with high-dust SCR can utilize these fuels provided they are mixed with other fuels with low alkali metal content.

Due to the cost of the catalyst SCR is used mainly at large facilities. NO<sub>x</sub> emission limit values are also lower for large facilities, giving further incentive to use SCR. SCR is rarely used in HOP because of their relatively small size, and their ability to reach below the NO<sub>x</sub> emission limit values without using SCR.

The limit values for NO<sub>x</sub> emissions are expected to be gradually tightened over time in the future. The technology in terms of combustion control, boiler design and improvements in the SNCR technology may relieve the need of SCR, but the application of SCR is nonetheless expected to increase in the future.

This is reflected in the datasheets by adding the cost of a tail-end DeNO<sub>x</sub> to the medium (and larger) plants at a certain point in the future. Application of SCR in the respective scenarios appears from the notes.

Desulfurization is not a big issue for wood firing because of the low sulfur content in the fuel. A typical sulfur content in wood is 0.04 g/GJ (dry basis) which has been used in the tables, and the generated SO<sub>2</sub> is to a large extent taken together with the ash and other pollutants (e.g. HCl and mercury) by particle filters in combination with flue gas condensation. On that basis we expect most plants to yield a very low SO<sub>2</sub> emission of up to 2 g/GJ. Plants will be built without wet-scrubbers which have the sole purpose of cleaning the flue gas, because they are not needed for fulfilling environmental requirements. In addition, the scrubbers would barely generate any gypsum due to the low sulfur content. If the plant does not include a flue gas condenser, the sulfur dioxide is expected to be captured in the bag filter, in a dry process, when injecting a small amount of hydrated lime. In a plant with a flue gas condenser the majority of sulfur dioxide will be captured here. The flue gas condenser can act as a wet scrubber when adding lime or sodium hydroxide to the circulating water.

Future plants above a certain capacity are required to have monitoring of air emissions of mercury, Hg. Generally, Hg is not a problem in straw fired units since Hg is oxidized by the chlorine in fuel and captured in the bag filter. Wood fired units might have a challenge with Hg if fired with woodchips from certain regions and only cleaning the flue gases with an electrostatic precipitator, ESP.

The EU Industrial Emission Directive (IED) [4], the directive on medium combustion plants [6], the BAT reference note on large combustion plants [5], the Danish guideline (Luftvejledning), [7], and air dispersion modelling make up the basis for determining the emission limits for a specific plant in Denmark. It is expected that new, lower emission limits will be introduced with the future legislation initiated by the EU.

The emissions in the Data Sheets from 2020 and in the following years are based on proposed limits in the coming Best Available Technologies Air Emission Levels (BAT AELs) introduced by the EU BREF document (BAT reference documents) for Large Combustion Plants [5] that is expected to come into force as of 2020. For small and medium scale plants, similar EU legislation is expected to come into force in the same timeframe, [6]. It is noted that emission limit values (ELV) for biomass plants are linked to the thermal input to the boiler in MW. More stringent requirements are valid for plants above 50 MW<sub>th input</sub> according to the EU IED [4] and air emission levels of the EU reference note on best available technology of large combustion plants, LCP BREF AEL [5].

Biomass units produce four sorts of residues: Flue gas, fly ash, bottom ash and possibly condensate from flue gas condensation.

All bottom ash and most fly ash from straw firing is recycled to farmland as a fertilizer.

Often ash from wood firing is deposited in landfills and some bottom ash is used as fertilizer. Research is ongoing on how to meet environmental acceptance limits for recycling the ash to forests. Bottom ash with relatively high content of cadmium cannot be used as fertilizer. Coal ash, if used as an additive, will make it impossible to use the ash as fertilizer, but opens the possibility to be used as coal ash in cement and concrete production.

The condensate water from wood firing is usually treated to remove heavy metals, particularly cadmium, so that its content reaches 3 milligrams per m<sup>3</sup>, or the level required for its discharge, which is usually the local municipal sewage system. The treatment may involve pH-adjustment, addition of polymers and flocculants and the use of belt filters for separation of the generated sludge. The treatment residue (sludge) must be deposited in a safe landfill. As described in the Introduction, condensate treatment may include electro deionization (EDI) and reverse osmosis to produce water that is virtually free of salts and pollutants. Hereby, it may be discharged to recipient or used for industrial purposes, such as topping up the water losses of the DH network. The condensate treatment is facilitated if an efficient particle separator is installed in the flue gas path upstream the flue gas condensation stage.

Condensate from straw-firing may be clean enough to be expelled without cleaning, since almost all cadmium is withheld with the fly ash in the bag filter.

### Research and development perspectives

Research is ongoing in many areas relevant for bio mass units, e.g.:

#### Both CHP, extraction and HOP:

- Reduce the cost of fuel, by improved collection and pre-treatment, better characterization and measurement methods.
- Improved combustion process for reduction of CO (that will also affect other unburned components e.g. PAH), NO<sub>x</sub>, particles and SO<sub>2</sub>
- Further development of secondary techniques for reduction of emissions of particles, aerosols, cadmium, NO<sub>x</sub> and SO<sub>2</sub>

- Improve boiler design and control of ammonia injection to allow efficient use of SNCR for DeNO<sub>x</sub> as an alternative to tail end SCR.
- Environmentally safe recycling of ashes to forestry; e.g. by pellets to ensure slow release of nutrients, alternatively recovery of potassium for generation of potassium fertilizer
- Cleaning condensate for reuse and discharge to recipient

### CHP and extraction:

- Improve control ability against fuel variations
- Reduce corrosion, in particular high-temperature corrosion
- Reduce slagging
- Improve steam cycle by introduction of steam reheat (>75 MW<sub>th input</sub>)
- Optimize the use of ORC systems in a Danish environment, including collection of operating experiences

### HOP – Heat Only Plants:

- Handling and combustion of new types of fuels, such as energy crops and garden/park waste

### New technology:

Instead of implementing the combustion process in the boiler vessel, an alternative Danish solution has been developed and demonstrated in three plants until now. The Energy Biomass Furnace combines updraft gasification and gas combustion. Hereby several advantages are achieved: The plant becomes simpler and possibly less expensive, the reactor is fuel flexible, the primary emissions are reduced and the furnace can regulate between 10-100 % according to the supplier.

The Biomass Furnace delivers hot flue gas to a commercial boiler. This concept is promising and has already drawn attention in the energy sector.

The plant in Sindal (2018) includes an ORC unit and a flue gas condenser, produces 800 kW electric power and 5 MW thermal heat.

### **Prediction of performance and cost**

Both biomass CHPs and HOPs represent today well-known technologies that has been erected in reasonably large numbers. Improvements can still be expected, but only at an incremental level. Therefore, the technology belongs to Category 4: Commercial technologies, with large deployment.

Development within this area is driven by possible prospects for being able to earn money and therefore also by the expected future prices on heat and power. Twenty years ago electric power was a valuable product and thus it was beneficial to aim at as high an electrical efficiency that could possibly be achieved. Today, power prices are in periods below prices of heat and this has a big impact on investment decisions; it is no longer certain that the electrical efficiency should be as high as possible. In years to come the difference between the units with highest electricity efficiency commercially available and the electricity efficiency of solutions actually bought will increase.

In the low capacity range (less than 25-30 MW<sub>th input</sub>) the scale of economics effect is quite considerable and there is a very significant economical difference between steam (and thereby electricity) producing boilers and hot water (DH

only) producing boilers. In particular boilers for the latter type can be series produced and are thus much cheaper than a boiler for producing super-heated steam for power production of similar size.

Wood chips heat only boilers (hot water) up to 20 MW thermal input have become very popular; they are produced in a more or less serial production and this lower both capital and O&M cost.

### Uncertainty

Biomass plants are fully commercial (Category 4) with small uncertainties for performances and costs. The trend of the recent years towards building large plants (>110 MW<sub>th input</sub> for CHPs and >25 MW<sub>th input</sub> for HOPs) including steam reheat (CHP only), absorption heat pumps for enhanced flue gas condensation, humidification of combustion air, more advanced flue gas cleaning etc., introduces a moderate increase of uncertainty. These advanced solutions are expected to be in Category 4 within a few years.

The real cost uncertainty is related to what extent the emission limits will be tightened. Further tightening of emissions requires development of more efficient combustions processes in the boiler and secondary flue gas cleaning systems. This will increase the capital costs and O&M cost.

### Examples of market standard available technology

#### CHPs:

- Fyn Power Plant (DK), Unit 8; commissioned in 2009; 120 MW<sub>th input</sub>, 35 MW<sub>e</sub> ; 84 MW district heat. 170,000 tonnes of straw per year. Equipped with flue gas condenser. Retrofitted with SCR tail end.
- Sleaford (UK) commissioned 2014, 115 MW<sub>th input</sub> (straw/wood chips), 38.5 MW<sub>e</sub>, net electrical efficiency 33%. 240,000 tonnes of straw per year.
- Lisbjerg (DK) commissioned 2016, 110 MW<sub>th input</sub>. Energy efficiency 103% at CHP mode. Equipped with tail end SCR, combustion air humidification and flue gas condenser.
- Snetterton (UK), commission year 2017, 130 MW<sub>th input</sub> (straw/wood chips), 44 MWe, net electrical efficiency 34%. 270,000 tonnes of straw per year.
- Avedøre Power Plant (DK) Unit 2 is a multi-fuel CHP extraction power plant that can operate on wood pellets, straw, oil (HFO), and natural gas. It was commissioned in 2002. It has a 100 MW<sub>th input</sub> separate biomass-fired boiler (ultra-super critical steam data – 290 bar, 540°C) supplying steam in parallel with the main boiler; 170,000 tonnes of straw per year. When the plant is running 100% on wood pellets in the main boiler and 100% straw, it is producing 425 MW<sub>e</sub> in condensing mode, and 355 MW<sub>e</sub> and 485 MW<sub>th</sub> heat output in backpressure CHP mode.
- In Denmark the two extraction plants Studstrup 3 and Avedøre 1 have recently been converted from coal firing into wood pellets firing. In Skærbæk a gas fired unit is converted into firing wood chips by installing 2 new grate fired boilers supplying steam to the existing turbine. In Herning a coal fired suspension boiler is equipped with grate thus enabling both wood chips and wood pellets combustion up to 90% load. The remaining 10% is natural gas.
- There are a few new large CHP plants expected to be built in the coming years. The currently known projects are Amager 4 and Asnæs 6.
- Sindal, commissioned 2018, combined updraft biomass gasification and combustion chamber with ORC, heat output 5 MW<sub>th</sub>, electricity generation 800 kW<sub>e</sub>.

#### HOPs:

- Hobro district heating (DK) commissioned 2017, 11.3 MW<sub>th input</sub> (wood chips) and 13 MW<sub>th output</sub>
- Hasle district heating (DK) commissioned 2017, 12 MW<sub>th input</sub> (wood chips) and 15 MW<sub>th output</sub>



- Lemvig district heating (DK) commissioned 2016, 8 MW<sub>th</sub> input (wood chips) and 10.4 MW<sub>th</sub> output
- Sønderborg district heating (DK) commissioned 2015, combined updraft biomass gasification and combustion chamber (various biomass), 9 MW<sub>th</sub> input and 9 MW<sub>th</sub> output.
- Bogense utility company (DK) commissioned 2011, combined updraft biomass gasification and combustion chamber (varied biomass), 8 MW<sub>th</sub> input and 8 MW<sub>th</sub> output.
- Hvidebæk district heating (DK) commissioned 2017, 7 MW<sub>th</sub> input (straw) and 7 MW<sub>th</sub> output
- Ørnhøj Grønbjerg district heating (DK) commissioned 2017, 1.7 4 MW<sub>th</sub> input (straw) and 1.5 MW<sub>th</sub> output
- Nexø halmvarmeværk (DK) commissioned 2016, with flue gas condensation and heatpump, 12 MW<sub>th</sub> input (straw) and 15 MW<sub>th</sub> output

### Additional remarks

Despite the observation that straw is a much more difficult fuel than wood (chips/pellets) the electricity efficiencies of CHP's are almost equal. This reflects the fact that the development of straw-fired CHP's for many years was driven by power utilities focusing on high electricity efficiencies.

The deployment of small and medium-sized biomass fired CHP plants in DK was largely inactive for some years after 2000, but changed conditions for DH is changing the situation. There are several trends in the area of new biomass CHP plants:

1. They are being built in large sizes, mainly because of a better plant economy, but also to accommodate for an increase in the DH market.
2. The electrical efficiency is not in focus due to low electricity prices.

Additional explanation of extraction contra backpressure units can be found in chapter *01 Supercritical Pulverized Fuel Power Plant*.

### References

- [1] "Life cycle assessment of Danish electricity and cogeneration", Energinet.dk, DONG Energy and Vattenfall, April 2010.
- [2] "Energy Technology Perspectives", IEA report, 2012
- [3] Input and comments by Burmeister & Wain Energy, 2015
- [4] Industrial Emissions Directive (IED), Directive 2010/75/EU of the European Parliament and of the Council of 24 November 2010 on industrial emissions (integrated pollution prevention and control). Available at <http://ec.europa.eu/environment/industry/stationary/ied/legislation.htm> (last visited 01.08.2018).
- [5] [Joint Research Centre, Institute for Prospective Technological Studies, Sustainable Production and Consumption Unit, European IPPC Bureau, Best Available Techniques \(BAT\) Reference Document for Large Combustion Plants, 2017. \(LCP BREF\)](#)
- [6] EU MCP Directive, DIRECTIVE (EU) 2015/2193 OF THE EUROPEAN PARLIAMENT AND OF THE COUNCIL of 25 November 2015 on the limitation of emissions of certain pollutants into the air from medium combustion plants, <https://eur-lex.europa.eu/legal-content/EN/TXT/PDF/?uri=CELEX:32015L2193&from=EN>.
- [7] Danish environmental protection agency, Luftvejledningen, Begrænsning af luftforurening fra virksomheder, Vejledning fra miljøstyrelsen Nr. 2 2001, <https://www2.mst.dk/udgiv/publikationer/2001/87-7944-625-6/pdf/87-7944-625-6.pdf> (air guideline, in Danish)
- [8] Dansk Fjernvarme, Input and comments 2015, 2017, not published



[9] Videncenter for Halm og Flis-fyring. Træ til energiformål, 1999.

[10] Danish Environmental Protection Agency, "En opdateret analyse af Danmarks muligheder for at reducere emissionerne af NO<sub>x</sub>" (Updated analysis of Denmark's options to reduce NO<sub>x</sub> emissions; in Danish), 2009.

[11] Danish Energy Agency, Energiproducenttællingen 2016.

## Data sheets for biomass plants

Data for biomass plants is presented in the following. First, data for the CHP's is presented.

Large backpressure units are shown with two different temperature sets (return- and forward temperature of the district heating network):

- 40/80 °C – corresponding to a plant connected to the distribution network
- 50/100 °C – corresponding to a plant connected to the transmission network

Furthermore, data for large extraction plants fuelled by wood chips and wood pellets is presented. Lastly, data for HOP plants is shown.

The total efficiency of plants with flue gas condensation is calculated assuming “direct condensation”, where the condensation heat is recovered directly with the available DH water without the use of heat pumps.

Condensation heat recovery can be augmented by cooling the flue gas further, typically to 30°C using heat pumps. In the datasheets, the row “Additional heat potential for heat pump (%)” contains the additional heat that a heat pump would recover from the flue gas by cooling it further to 30°C. The so produced additional heat is the sum of this recovered amount of heat and any external driving energy (electricity or steam) supplied to drive the heat pump.

For more information see Introduction to Waste and Biomass plants.

Data sheets Wood Chips CHP, small

| Technology   | Small Wood Chips CHP, 20 MW feed |         |         |         |                    |         |                    |         |         |     |
|--|----------------------------------|---------|---------|---------|--------------------|---------|--------------------|---------|---------|-----|
|  | 2015                             | 2020    | 2030    | 2050    | Uncertainty (2020) |         | Uncertainty (2050) |         | Note    | Ref |
| <b>Energy/technical data</b>                                 |                                  |         |         |         | Lower              | Upper   | Lower              | Upper   |         |     |
| Generating capacity for one unit (MWe)                       | 2.9                              | 2.9     | 2.9     | 2.9     | 2.8                | 3.0     | 2.8                | 3.0     | A       |     |
| Electricity efficiency, net (%), name plate                  | 14.7                             | 14.7    | 14.7    | 14.4    | 14                 | 15      | 13                 | 15      | A, H    | 1   |
| Electricity efficiency, net (%), annual average              | 13.9                             | 13.9    | 14.0    | 13.7    | 12                 | 15      | 12                 | 15      | A, H    | 1   |
| Auxiliary electricity consumption (% of thermal input)       | 2.7                              | 2.7     | 2.7     | 2.7     | 2                  | 3       | 2                  | 3       |         | 1   |
| Cb coefficient (40°C/80°C)                                   | 0.15                             | 0.15    | 0.15    | 0.15    | 0.15               | 0.15    | 0.14               | 0.15    |         |     |
| Cv coefficient (40°C/80°C)                                   | 1                                | 1       | 1       | 1       | 1                  | 1       | 1                  | 1       | I       |     |
| Forced outage (%)  | 3                                | 3       | 3       | 3       | 3                  | 3       | 3                  | 3       |         |     |
| Planned outage (weeks per year)                              | 3.0                              | 3.0     | 3.0     | 3.0     | 2.6                | 3.5     | 2.3                | 3.8     |         |     |
| Technical lifetime (years)                                   | 25                               | 25      | 25      | 25      | 20                 | 35      | 20                 | 35      |         | 1   |
| Construction time (years)                                    | 1                                | 1       | 1       | 1       | 0.5                | 1.5     | 0.5                | 1.5     |         | 1   |
| Space requirement (1000 m2/MWe)                              | 0.7                              | 0.7     | 0.7     | 0.7     | 0.6                | 0.8     | 0.5                | 0.9     |         |     |
| <b>Regulation ability</b>                                    |                                  |         |         |         |                    |         |                    |         |         |     |
| Primary regulation (% per 30 seconds)                        | NA                               | NA      | NA      | NA      | NA                 | NA      | NA                 | NA      |         |     |
| Secondary regulation (% per minute)                          | 10                               | 10      | 10      | 10      | 10                 | 10      | 10                 | 10      | D       | 1   |
| Minimum load (% of full load)                                | 20                               | 20      | 20      | 20      | 20                 | 20      | 20                 | 20      | D       | 1   |
| Warm start-up time (hours)                                   | 0.25                             | 0.25    | 0.25    | 0.25    | 0.25               | 0.25    | 0.25               | 0.25    | G       | 1   |
| Cold start-up time (hours)                                   | 0.5                              | 0.5     | 0.5     | 0.5     | 0.5                | 0.5     | 0.5                | 0.5     |         | 1   |
| <b>Environment</b>   |                                  |         |         |         |                    |         |                    |         |         |     |
| SO <sub>2</sub> (degree of desulphuring, %)                  | 98.0                             | 98.0    | 98.0    | 98.0    | 94.9               | 99.0    | 98.0               | 99.0    | F       | 1,2 |
| NO <sub>x</sub> (g per GJ fuel)                              | 90                               | 60      | 40      | 30      | 40                 | 80      | 20                 | 40      | F       | 1,2 |
| CH <sub>4</sub> (g per GJ fuel)                              | 20                               | 10      | 8       | 4       | 4                  | 16      | 2                  | 16      | F       | 1,2 |
| N <sub>2</sub> O (g per GJ fuel)                             | 1                                | 1       | 1       | 1       | 1                  | 3       | 0                  | 1       | F       | 1,2 |
| Particles (g per GJ fuel)                                    | 2.0                              | 0.3     | 0.3     | 0.3     | 0.1                | 2.0     | 0.1                | 1.0     | F       | 1,2 |
| <b>Financial data</b>  |                                  |         |         |         |                    |         |                    |         |         |     |
| Nominal investment (M€/MWe)                                  | 6.5                              | 6.3     | 6.0     | 5.8     | 5.5                | 7.4     | 4.6                | 7.9     | E, J, K | 1   |
| - of which equipment   | 4.0                              | 3.9     | 3.7     | 3.7     | 3.4                | 4.6     | 2.8                | 5.0     | K       |     |
| - of which installation                                      | 2.5                              | 2.4     | 2.3     | 2.1     | 2.1                | 2.8     | 1.7                | 2.9     | K       |     |
| Fixed O&M (€/MWe/year)                                       | 285,000                          | 281,000 | 273,000 | 270,000 | 241,000            | 326,000 | 205,000            | 347,000 |         |     |
| Variable O&M (€/MWh <sub>e</sub> )                           | 9.3                              | 9.3     | 9.2     | 9.4     | 6.4                | 10.4    | 5.8                | 11.4    | L       |     |
| <b>Technology specific data</b>                              |                                  |         |         |         |                    |         |                    |         |         |     |
| Steam reheat   | None                             | None    | None    | None    | None               | None    | None               | None    |         |     |
| Flue gas condensation  | Yes                              | Yes     | Yes     | Yes     | No                 | Yes     | No                 | Yes     | C       |     |
| Combustion air humidification                                | Yes                              | Yes     | Yes     | Yes     | No                 | Yes     | No                 | Yes     | C       |     |
| Output of recovered condensate (tonne/MWh <sub>input</sub> ) | 0.28                             | 0.28    | 0.28    | 0.28    | 0.00               | 0.28    | 0.00               | 0.28    | C, L    |     |

|  |        |        |        |        |        |        |        |        |      |   |
|--|--------|--------|--------|--------|--------|--------|--------|--------|------|---|
| Nominal investment (M€/MW fuel input)                                    | 0.95   | 0.93   | 0.88   | 0.84   | 0.81   | 1.09   | 0.66   | 1.14   | J, K | 1 |
| - of which equipment   | 0.59   | 0.58   | 0.55   | 0.53   | 0.50   | 0.68   | 0.41   | 0.72   | K    |   |
| - of which installation  | 0.36   | 0.35   | 0.33   | 0.30   | 0.31   | 0.41   | 0.25   | 0.42   | K    |   |
| Fixed O&M (€/MW input/year)  | 41,800 | 41,200 | 40,200 | 39,000 | 35,300 | 47,800 | 29,600 | 50,100 |      |   |
| Variable O&M (€/MWh input)   | 1.4    | 1.4    | 1.4    | 1.4    | 0.9    | 1.6    | 0.8    | 1.7    | L    |   |
| Fuel storage specific cost in excess of 2 days (M€/MW_input/storage day) | 0.020  | 0.020  | 0.019  | 0.017  | 0.017  | 0.023  | 0.014  | 0.023  | K    |   |
| Heat efficiency, net (%), name plate                                     | 96.6   | 96.6   | 96.5   | 96.8   | 71     | 98     | 69     | 98     | B, H | 1 |
| Heat efficiency, net (%), annual average                                 | 97.3   | 97.3   | 97.3   | 97.5   | 73     | 98     | 70     | 98     | B, H | 1 |
| Additional heat potential with heat pumps (% of thermal input)           | 1.9    | 1.9    | 1.9    | 1.9    | 1      | 26     | 1      | 28     | C    | 1 |

**Notes:**

- A The plant is directly producing hot water for District Heating by burning fuel on a grate. The electric power is produced by an ORC module (Organic Rankine Cycle; Waste Heat Recovery - WHR). Refer for instance to the following link for further information about technology and suppliers: [http://www.enova.no/upload\\_images/36AC689098414B05A7112FA2EE985BDA.pdf](http://www.enova.no/upload_images/36AC689098414B05A7112FA2EE985BDA.pdf) This is low temperature and low efficiency electric power but at an affordable price.
- The system is optimised at DH return temperature 40°C and flow 80°C.
- B Boilers up to 20 MW fuel input for hot water production are more or less standardized products with a high degree of fuel flexibility (type of biomass, humidity etc.)
- C Additional heat potential for heat pump is the flue gas condensation potential remaining after the direct condensation stage (condensation by heat exchange with DH-water). Direct condensation and combustion air humidification are included in all cases except in lower/upper range of 2020 and 2050.
- D Secondary regulation normally relates to power production; for this type of plant it may not be of importance. Though, the load control of the heat production is important, and most units will perform better than the figure shown. Also, minimum load could be substantially lower.
- E Since electricity generation is only a secondary objective for minor heat producers, it may make more sense to relate the total investment only to the heat production capacity.
- F Emissions shall comply with the order of the Danish EPA no 1535 of 2019 (Bekendtgørelse om miljøkrav for mellemstore fyringsanlæg), implementing the Medium Combustion Directive, Directive (EU) 2015/2193 of the European Parliament and of the Council of 25 November 2015 on the limitation of emissions of certain pollutants into the air from medium combustion plants..  
It is anticipated that for the smaller units the supplier has an SNCR solution to reduce NOx emissions sufficiently. However, to reach NOx-levels below 40 g/GJ SCR is assumed.
- G Warm start is starting with a glowing fuel layer on the grate.
- H The total efficiency is the sum of electricity efficiency and heat efficiency, applicable for "name plate" and "annual average", respectively. The "annual average" electricity efficiency is lower than "name plate" due to turbine outages and other incidents. The resulting lost power production is recovered as heat. This is why "annual average" heat efficiency is higher than "name plate" heat. Efficiencies refer to lower heating value. The parasitic electricity consumption has been subtracted in the listed electricity efficiencies.
- I Through a turbine by-pass all the produced steam energy can be used for District Heat production. It can be assumed that all electricity production is converted into heat production in by-pass.
- J Investment applies to a standard plant. There could be cost related to the actual project or site that adds to the total investment, e.g. additional fuel storage, facilities for chipping of logs, conditions for foundation and harbour facilities.  
Financial data and Technological specific data are essentially the total cost either divided by the electric net capacity, i.e. corresponding to the indicated name plate efficiencies, or by the thermal input. This is to indicate that new plants may not fully take advantage of the technical capabilities for full electricity production capacity. The two cost for electricity and thermal input, respectively, are not to be added up!

- K Note that investments include only two days fuel storage, and more may be optimal, depending on fuel supply opportunities and heat supply obligations, amongst other things.  
The additional investment is listed in the bottom row.
- L Variable O&M cost includes consumables (for FGT etc.), disposal of residues and maintenance cost. Cost for disposal of recovered flue gas condensate is included at a rate of 1.0 €/tonne of condensate. Electricity consumption is not included for CHP, and revenues from sale of electricity and heat are not included. Taxes are not included.

### References

- 1 Rambøll Danmark, internal model and evaluation based on either existing projects, supplier offers, or pre-project studies.
- 2 Estimated from emission factors of 2006: 81 g/GJ NO<sub>x</sub>, 1.9 g/GJ for SO<sub>2</sub>, <1 g/GJ for CH<sub>4</sub>, 0.8 g/GJ for N<sub>2</sub>O, 10 g/GJ for Particles; cf. Nielsen, M., Nielsen, O.-K. & Thomsen, M. 2010: Emissions from decentralised CHP plants 2007 - Energinet.dk Environmental project no. 07/1882. Project report 5 – Emission factors and emission inventory for decentralised CHP production. National Environmental Research Institute, Aarhus University. 113 pp. – NERI Technical report No. 786. <http://www.dmu.dk/Pub/FR786.pdf>.

## Data sheets Wood Chips CHP, medium

| Technology   | Medium Wood Chips CHP, 80 MW feed |      |      |      |                    |       |                    |       |         |       |
|--|-----------------------------------|------|------|------|--------------------|-------|--------------------|-------|---------|-------|
|  | 2015                              | 2020 | 2030 | 2050 | Uncertainty (2020) |       | Uncertainty (2050) |       | Note    | Ref   |
| <b>Energy/technical data</b>                           |                                   |      |      |      | Lower              | Upper | Lower              | Upper |         |       |
| Generating capacity for one unit (MWe)                 | 23.8                              | 23.8 | 23.9 | 23.4 | 22.2               | 31.8  | 22.7               | 32.7  | A       |       |
| Electricity efficiency, net (%), name plate            | 29.7                              | 29.7 | 29.8 | 29.3 | 27                 | 40    | 28                 | 41    | A, H, F | 1     |
| Electricity efficiency, net (%), annual average        | 28.2                              | 28.2 | 28.3 | 27.8 | 24                 | 38    | 25                 | 39    | A, H, F | 1     |
| Auxiliary electricity consumption (% of thermal input) | 3.0                               | 3.0  | 3.0  | 3.0  | 2                  | 3     | 2                  | 3     |         | 1     |
| Cb coefficient (40°C/80°C)                             | 0.37                              | 0.37 | 0.37 | 0.36 | 0.34               | 0.49  | 0.35               | 0.50  |         |       |
| Cv coefficient (40°C/80°C)                             | 1                                 | 1    | 1    | 1    | 1                  | 1     | 1                  | 1     | B, I    |       |
| Forced outage (%)                                      | 3                                 | 3    | 3    | 3    | 3                  | 3     | 3                  | 3     |         |       |
| Planned outage (weeks per year)                        | 3.0                               | 3.0  | 3.0  | 3.0  | 2.6                | 3.5   | 2.3                | 3.8   |         |       |
| Technical lifetime (years)                             | 25                                | 25   | 25   | 25   | 20                 | 35    | 20                 | 35    |         | 1     |
| Construction time (years)                              | 2.5                               | 2.5  | 2.5  | 2.5  | 2                  | 3     | 1.5                | 3     |         | 1     |
| Space requirement (1000 m <sup>2</sup> /MWe)           | 0.21                              | 0.21 | 0.21 | 0.21 | 0.18               | 0.24  | 0.16               | 0.27  |         |       |
| <b>Regulation ability</b>                              |                                   |      |      |      |                    |       |                    |       |         |       |
| Primary regulation (% per 30 seconds)                  | NA                                | NA   | NA   | NA   | NA                 | NA    | NA                 | NA    |         |       |
| Secondary regulation (% per minute)                    | 4                                 | 4    | 4    | 4    | 4                  | 4     | 4                  | 4     | D       | 1     |
| Minimum load (% of full load)                          | 20                                | 20   | 20   | 20   | 20                 | 20    | 20                 | 20    |         |       |
| Warm start-up time (hours)                             | 2                                 | 2    | 2    | 2    | 2                  | 2     | 2                  | 2     | E+G     | 1     |
| Cold start-up time (hours)                             | 8                                 | 8    | 8    | 8    | 8                  | 8     | 8                  | 8     |         | 1     |
| <b>Environment</b>                                     |                                   |      |      |      |                    |       |                    |       |         |       |
| SO <sub>2</sub> (degree of desulphuring, %)            | 98.0                              | 98.0 | 98.0 | 98.0 | 94.9               | 99.0  | 98.0               | 99.0  | F       | 1,2,3 |
| NO <sub>x</sub> (g per GJ fuel)                        | 90                                | 60   | 40   | 20   | 40                 | 60    | 20                 | 40    | F       | 1,2,3 |
| CH <sub>4</sub> (g per GJ fuel)                        | 3                                 | 2    | 2    | 1    | 1                  | 3     | 0                  | 3     | F       | 1,2,3 |
| N <sub>2</sub> O (g per GJ fuel)                       | 1                                 | 1    | 1    | 1    | 1                  | 3     | 0                  | 1     | F       | 1,2,3 |
| Particles (g per GJ fuel)                              | 2.0                               | 0.3  | 0.3  | 0.3  | 0.1                | 2.0   | 0.1                | 1.0   | F       | 1,2,3 |
| <b>Financial data</b>                                  |                                   |      |      |      |                    |       |                    |       |         |       |
| Nominal investment (M€/MWe)                            | 3.6                               | 3.5  | 3.4  | 3.2  | 3.0                | 4.2   | 2.5                | 4.4   | J, K    | 1     |
| - of which equipment                                   | 2.4                               | 2.4  | 2.2  | 2.2  | 1.9                | 2.8   | 1.6                | 3.0   | K       |       |

|  |         |         |         |         |         |         |        |         |      |   |
|--|---------|---------|---------|---------|---------|---------|--------|---------|------|---|
| - of which installation  | 1.2     | 1.2     | 1.1     | 1.0     | 1.0     | 1.4     | 0.8    | 1.4     | K    |   |
| Fixed O&M (€/MWe/year)   | 154,000 | 149,000 | 140,000 | 129,000 | 126,000 | 173,000 | 97,000 | 167,000 |      |   |
| Variable O&M (€/MWh_e)   | 4.5     | 4.5     | 4.5     | 4.6     | 3.2     | 5.1     | 2.8    | 5.5     | L    |   |
| <b>Technology specific data</b>  |         |         |         |         |         |         |        |         |      |   |
| Steam reheat   | None    | None    | None    | None    | None    | Yes     | None   | Yes     |      |   |
| Flue gas condensation  | Yes     | Yes     | Yes     | Yes     | No      | Yes     | No     | Yes     | C    |   |
| Combustion air humidification  | Yes     | Yes     | Yes     | Yes     | No      | Yes     | No     | Yes     | C    |   |
| Output of recovered condensate (tonne/MWh_input)                         | 0.25    | 0.25    | 0.25    | 0.25    | 0.00    | 0.26    | 0.00   | 0.26    | C, L |   |
| Nominal investment (M€/MW fuel input)                                    | 1.08    | 1.05    | 1.00    | 0.94    | 0.88    | 1.24    | 0.72   | 1.28    | J, K | 1 |
| - of which equipment   | 0.72    | 0.71    | 0.67    | 0.64    | 0.58    | 0.83    | 0.47   | 0.87    | K    |   |
| - of which installation  | 0.36    | 0.35    | 0.33    | 0.30    | 0.30    | 0.41    | 0.25   | 0.41    | K    |   |
| Fixed O&M (€/MW input/year)  | 45,800  | 44,400  | 41,800  | 37,800  | 37,300  | 51,500  | 28,300 | 48,800  |      |   |
| Variable O&M (€/MWh input)   | 1.4     | 1.4     | 1.4     | 1.4     | 0.9     | 1.5     | 0.8    | 1.6     | L    |   |
| Fuel storage specific cost in excess of 2 days (M€/MW_input/storage day) | 0.015   | 0.015   | 0.014   | 0.013   | 0.013   | 0.017   | 0.010  | 0.017   | K    |   |
| Heat efficiency, net (%), name plate                                     | 81.2    | 81.2    | 81.1    | 81.7    | 46      | 84      | 43     | 83      | B, H | 1 |
| Heat efficiency, net (%), annual average                                 | 82.7    | 82.7    | 82.6    | 83.1    | 49      | 86      | 46     | 85      | B, H | 1 |
| Additional heat potential with heat pumps (% of thermal input)           | 1.9     | 1.9     | 1.9     | 1.9     | 1       | 26      | 1      | 28      | C    | 1 |

**Notes:**

- A The boiler in the plant is a grate fired boiler producing steam to be used in a subsequent backpressure steam turbine. Though a grate is reasonable flexible with respect to combusting different fuels the fuel feed system will be dependent on the type of fuel. It is to be expected that it is necessary with a specific DeNOx plant (SNCR might not be sufficient).
- The system is optimised at DH return temperature 40°C and flow 80°C.
- B Through a turbine by-pass all the produced steam energy can be used for District Heat production. It can be assumed that all electricity production is converted into heat production in by-pass.
- C Additional heat potential for heat pump is the flue gas condensation potential remaining after the direct condensation stage (condensation by heat exchange with DH-water). Direct condensation and combustion air humidification are included in all cases except in lower/upper range of 2020 and 2050.
- D Secondary regulation normally relates to power production; for this type of plant it may not be of importance since load will normally follow heat consumption.

- E A limiting factor for the hot and cold start-up times is the size of the hot water tank (deaerator).
- F It is to be expected that necessary DeNO<sub>x</sub> can be accomplished using SNCR, except where anticipated emission levels are below 40 g/GJ in which case SCR is used with slight adverse effect on electricity efficiency. From 2017 NO<sub>x</sub> (and other emissions) must fulfil the BAT\_AEL values of the LCP BREF note.
- G Warm start is starting with a glowing fuel layer on the grate and a warm deaerator.
- H The total efficiency is the sum of electricity efficiency and heat efficiency, applicable for "name plate" and "annual average", respectively. The "annual average" electricity efficiency is lower than "name plate" due to turbine outages and other incidents. The resulting lost power production is recovered as heat. This is why "annual average" heat efficiency is higher than "name plate" heat. Efficiencies refer to lower heating value. The parasitic electricity consumption has been subtracted in the listed electricity efficiencies.
- I The Cv value does not exist for plants with a backpressure turbine or an ORC turbine
- J Investment applies to a standard plant. There could be cost related to the actual project or site that adds to the total investment, e.g. additional fuel storage, facilities for chipping of logs, conditions for foundation and harbour facilities.  
Financial data and Technological specific data are essentially the total cost either divided by the electric net capacity, i.e. corresponding to the indicated name plate efficiencies, or by the thermal input. This is to indicate that new plants may not fully take advantage of the technical capabilities for full electricity production capacity. The two cost for electricity and thermal input, respectively, are not to be added up!
- K Note that investments include only two days fuel storage, and more may be optimal, depending on fuel supply opportunities and heat supply obligations, amongst other things.  
The additional investment is listed in the bottom row.
- L Variable O&M cost includes consumables (for FGT etc.), disposal of residues and maintenance cost. Cost for disposal of recovered flue gas condensate is included at a rate of 1.0 €/tonne of condensate. Electricity consumption is not included for CHP, and revenues from sale of electricity and heat are not included. Taxes are not included.

### References

- 1 Rambøll Danmark, internal evaluation based on either existing projects, supplier offers, or pre-project studies.
- 2 EU-commission, LCP BREF note. Thierry Lecomte, José Félix Ferrería de la Fuente, Frederik Neuwahl, Michele Canova, Antoine Pinasseau, Ivan Jankov, Thomas Brinkmann, Serge Roudier, Luis Delgado Sancho; Best Available Techniques (BAT) Reference Document for Large Combustion Plants; EUR 28836 EN; doi:10.2760/949
- 3 Estimated from emission factors of 2006: 81 g/GJ NO<sub>x</sub>, 1.9 g/GJ for SO<sub>2</sub>, <1 g/GJ for CH<sub>4</sub>, 0.8 g/GJ for N<sub>2</sub>O, 10 g/GJ for Particles; cf. Nielsen, M., Nielsen, O.-K. & Thomsen, M. 2010: Emissions from decentralised CHP plants 2007 - Energinet.dk Environmental project no. 07/1882. Project report 5 – Emission factors and emission inventory for decentralised CHP production. National Environmental Research Institute, Aarhus University. 113 pp. – NERI Technical report No. 786. <http://www.dmu.dk/Pub/FR786.pdf>.



## Data sheets Wood Chips CHP, large, 40/80 °C return/forward temperature

| Technology   | Large Wood Chips CHP, 600 MW feed |        |        |        |                    |         |                    |         |      |     |
|--|-----------------------------------|--------|--------|--------|--------------------|---------|--------------------|---------|------|-----|
|  | 2015                              | 2020   | 2030   | 2050   | Uncertainty (2020) |         | Uncertainty (2050) |         | Note | Ref |
| <b>Energy/technical data</b>                           |                                   |        |        |        | Lower              | Upper   | Lower              | Upper   |      |     |
| Generating capacity for one unit (MWe)                 | 182.2                             | 182.6  | 183.3  | 180.1  | 166.3              | 242.9   | 174.4              | 251.0   | A    |     |
| Electricity efficiency, net (%), name plate            | 30.4                              | 30.4   | 30.5   | 30.0   | 27                 | 41      | 29                 | 42      | A, H | 1   |
| Electricity efficiency, net (%), annual average        | 28.9                              | 28.9   | 29.0   | 28.5   | 24                 | 39      | 26                 | 40      | A, H | 1   |
| Auxiliary electricity consumption (% of thermal input) | 3.0                               | 2.9    | 2.9    | 2.9    | 2                  | 3       | 2                  | 3       |      | 1   |
| Cb coefficient (40°C/80°C)                             | 0.37                              | 0.37   | 0.38   | 0.37   | 0.34               | 0.50    | 0.35               | 0.51    |      |     |
| Cv coefficient (40°C/80°C)                             | 1                                 | 1      | 1      | 1      | 1                  | 1       | 1                  | 1       | B, I |     |
| Forced outage (%)                                      | 3                                 | 3      | 3      | 3      | 3                  | 3       | 3                  | 3       |      |     |
| Planned outage (weeks per year)                        | 3.0                               | 3.0    | 3.0    | 3.0    | 2.6                | 3.5     | 2.3                | 3.8     |      |     |
| Technical lifetime (years)                             | 25                                | 25     | 25     | 25     | 20                 | 35      | 20                 | 35      |      | 1   |
| Construction time (years)                              | 5                                 | 5      | 5      | 5      | 4.5                | 5.5     | 4                  | 5.5     |      | 1   |
| Space requirement (1000 m <sup>2</sup> /MWe)           | 0.08                              | 0.08   | 0.08   | 0.08   | 0.07               | 0.09    | 0.06               | 0.10    |      | 1   |
| <b>Regulation ability</b>                              |                                   |        |        |        |                    |         |                    |         |      |     |
| Primary regulation (% per 30 seconds)                  | 2                                 | 2      | 2      | 2      | 2                  | 2       | 2                  | 2       |      |     |
| Secondary regulation (% per minute)                    | 4                                 | 4      | 4      | 4      | 4                  | 4       | 4                  | 4       | D    | 1   |
| Minimum load (% of full load)                          | 45                                | 45     | 45     | 45     | 45                 | 45      | 45                 | 45      |      |     |
| Warm start-up time (hours)                             | 2                                 | 2      | 2      | 2      | 2                  | 2       | 2                  | 2       | E+G  | 1   |
| Cold start-up time (hours)                             | 12                                | 12     | 12     | 12     | 12                 | 12      | 12                 | 12      |      | 1   |
| <b>Environment</b>                                     |                                   |        |        |        |                    |         |                    |         |      |     |
| SO <sub>2</sub> (degree of desulphuring, %)            | 98.0                              | 98.0   | 98.0   | 98.0   | 94.9               | 99.0    | 98.0               | 99.0    | F    | 1,2 |
| NO <sub>x</sub> (g per GJ fuel)                        | 30                                | 20     | 20     | 10     | 10                 | 30      | 10                 | 20      | F    | 1,2 |
| CH <sub>4</sub> (g per GJ fuel)                        | 3                                 | 2      | 2      | 1      | 1                  | 3       | 0                  | 3       | F    | 1,2 |
| N <sub>2</sub> O (g per GJ fuel)                       | 10                                | 8      | 6      | 5      | 5                  | 10      | 3                  | 10      | F    | 1,2 |
| Particles (g per GJ fuel)                              | 0.3                               | 0.3    | 0.3    | 0.3    | 0.1                | 2.0     | 0.1                | 1.0     | F    | 1,2 |
| <b>Financial data</b>                                  |                                   |        |        |        |                    |         |                    |         |      |     |
| Nominal investment (M€/MWe)                            | 3.4                               | 3.3    | 3.1    | 2.9    | 2.8                | 3.9     | 2.3                | 4.0     | J, K | 1   |
| - of which equipment                                   | 2.2                               | 2.1    | 2.0    | 1.9    | 1.8                | 2.6     | 1.5                | 2.6     | K    |     |
| - of which installation                                | 1.2                               | 1.2    | 1.1    | 1.0    | 1.0                | 1.4     | 0.8                | 1.4     | K    |     |
| Fixed O&M (€/MWe/year)                                 | 97,000                            | 95,000 | 89,000 | 84,000 | 80,000             | 111,000 | 64,000             | 110,000 |      |     |
| Variable O&M (€/MWh <sub>e</sub> )                     | 4.4                               | 4.4    | 4.4    | 4.5    | 3.1                | 4.9     | 2.8                | 5.4     | L    |     |
| <b>Technology specific data</b>                        |                                   |        |        |        |                    |         |                    |         |      |     |

|  |        |        |        |        |        |        |        |        |      |   |
|--|--------|--------|--------|--------|--------|--------|--------|--------|------|---|
| Steam reheat   | None   | None   | None   | None   | None   | Yes    | None   | Yes    |      |   |
| Flue gas condensation  | Yes    | Yes    | Yes    | Yes    | No     | Yes    | No     | Yes    | C    |   |
| Combustion air humidification  | Yes    | Yes    | Yes    | Yes    | No     | Yes    | No     | Yes    | C    |   |
| Output of recovered condensate (tonne/MWh_input)                         | 0.25   | 0.25   | 0.25   | 0.25   | 0.00   | 0.26   | 0.00   | 0.26   | C, L |   |
| Nominal investment (M€/MW fuel input)                                    | 1.03   | 1.00   | 0.95   | 0.88   | 0.85   | 1.20   | 0.70   | 1.21   | J, K | 1 |
| - of which equipment   | 0.66   | 0.65   | 0.62   | 0.58   | 0.54   | 0.78   | 0.44   | 0.79   | K    |   |
| - of which installation  | 0.36   | 0.35   | 0.34   | 0.30   | 0.31   | 0.42   | 0.25   | 0.42   | K    |   |
| Fixed O&M (€/MW input/year)  | 29,500 | 28,800 | 27,300 | 25,100 | 24,300 | 33,900 | 19,100 | 32,900 |      |   |
| Variable O&M (€/MWh input)   | 1.4    | 1.4    | 1.4    | 1.4    | 0.9    | 1.5    | 0.8    | 1.6    | L    |   |
| Fuel storage specific cost in excess of 2 days (M€/MW_input/storage day) | 0.010  | 0.010  | 0.009  | 0.008  | 0.009  | 0.012  | 0.007  | 0.012  | K    |   |
| Heat efficiency, net (%), name plate                                     | 81.4   | 81.5   | 81.4   | 82.0   | 44     | 85     | 43     | 83     | B, H | 1 |
| Heat efficiency, net (%), annual average                                 | 82.9   | 83.1   | 83.0   | 83.5   | 47     | 87     | 46     | 85     | B, H | 1 |
| Additional heat potential with heat pumps (% of thermal input)           | 1.9    | 1.9    | 1.9    | 1.9    | 1      | 28     | 1      | 28     | C    | 1 |

**Notes:**

- A The boiler in the plant is a circulating fluid bed boiler (CFB) producing steam to be used in a subsequent back-pressure steam turbine without steam re-heat. The system is optimised at DH return temperature 40°C and flow 80°C.
- B Through a turbine by-pass all the produced steam energy can be used for District Heat production. It can be assumed that all electricity production is converted into heat production in by-pass.
- C Additional heat potential for heat pump is the flue gas condensation potential remaining after the direct condensation stage (condensation by heat exchange with DH-water). Direct condensation and combustion air humidification are included in all cases except in lower/upper range of 2020 and 2050.
- D Secondary regulation normally relates to power production; for this type of plant it may not be of importance since load will normally follow heat consumption.
- E A limiting factor for the hot and cold start-up times is the size of the hot water tank (deaerator). Warm start-up time is particularly low for fluid bed types of plants.
- F It is to be expected that the NOx level is low from the CFB, and that the necessary DeNOx can be accomplished using SNCR, except where anticipated emission levels are below 20 g/GJ, in which case SCR is used. From 2017 NOx (and other emissions) must fulfil the BAT\_AEL values of the LCP BREF note.
- G Warm start is starting with a glowing bed and a warm deaerator.
- H The total efficiency is the sum of electricity efficiency and heat efficiency, applicable for "name plate" and "annual average", respectively. The "annual average" electricity efficiency is lower than "name plate" due to turbine outages and other incidents. The resulting lost power production is recovered as heat. This is why "annual average" heat efficiency is higher than "name plate" heat. Efficiencies refer to lower heating value. The parasitic electricity consumption has been subtracted in the listed electricity efficiencies.

- I The Cv value does not exist for plants with a backpressure turbine or an ORC turbine
- J Investment applies to a standard plant. There could be cost related to the actual project or site that adds to the total investment, e.g. additional fuel storage, facilities for chipping of logs, conditions for foundation and harbour facilities.  
Financial data and Technological specific data are essentially the total cost either divided by the electric net capacity, i.e. corresponding to the indicated name plate efficiencies, or by the thermal input. This is to indicate that new plants may not fully take advantage of the technical capabilities for full electricity production capacity. The two cost for electricity and thermal input, respectively, are not to be added up!
- K Note that investments include only two days fuel storage, and more may be optimal, depending on fuel supply opportunities and heat supply obligations, amongst other things.  
The additional investment is listed in the bottom row.
- L Variable O&M cost includes consumables (for FGT etc.), disposal of residues and maintenance cost. Cost for disposal of recovered flue gas condensate is included at a rate of 1.0 €/tonne of condensate. Electricity consumption is not included for CHP, and revenues from sale of electricity and heat are not included. Taxes are not included.

### References

- 1 Rambøll Danmark, internal evaluation based on either existing projects, supplier offers, or pre-project studies.
- 2 EU-commission, LCP BREF note. Thierry Lecomte, José Félix Ferrería de la Fuente, Frederik Neuwahl, Michele Canova, Antoine Pinasseau, Ivan Jankov, Thomas Brinkmann, Serge Roudier, Luis Delgado Sancho; Best Available Techniques (BAT) Reference Document for Large Combustion Plants; EUR 28836 EN; doi:10.2760/949
- 3 Estimated from emission factors of 2006: 81 g/GJ NO<sub>x</sub>, 1.9 g/GJ for SO<sub>2</sub>, <1 g/GJ for CH<sub>4</sub>, 0.8 g/GJ for N<sub>2</sub>O, 10 g/GJ for Particles; cf. Nielsen, M., Nielsen, O.-K. & Thomsen, M. 2010: Emissions from decentralised CHP plants 2007 - Energinet.dk Environmental project no. 07/1882. Project report 5 – Emission factors and emission inventory for decentralised CHP production. National Environmental Research Institute, Aarhus University. 113 pp. – NERI Technical report No. 786. <http://www.dmu.dk/Pub/FR786.pdf>.

## Data sheets Wood Chips CHP, large, 50/100 °C return/forward temperature

| Technology   | Large Wood Chips CHP, 600 MW feed |       |       |       |                    |       |                    |       | Note | Ref   |
|--|-----------------------------------|-------|-------|-------|--------------------|-------|--------------------|-------|------|-------|
|  | 2015                              | 2020  | 2030  | 2050  | Uncertainty (2020) |       | Uncertainty (2050) |       |      |       |
| Energy/technical data                                  | Lower                             |       | Upper |       | Lower              |       | Upper              |       |      |       |
| Generating capacity for one unit (MWe)                 | 169.5                             | 169.8 | 170.5 | 167.5 | 153.7              | 230.2 | 162.2              | 238.7 | A    |       |
| Electricity efficiency, net (%), name plate            | 28.3                              | 28.3  | 28.4  | 27.9  | 25                 | 39    | 27                 | 40    | A, H | 1     |
| Electricity efficiency, net (%), annual average        | 26.8                              | 26.9  | 27.0  | 26.5  | 23                 | 37    | 24                 | 38    | A, H | 1     |
| Auxiliary electricity consumption (% of thermal input) | 3.0                               | 3.0   | 3.0   | 3.0   | 2                  | 3     | 2                  | 3     |      | 1     |
| Cb coefficient (50°C/100°C)                            | 0.35                              | 0.35  | 0.35  | 0.34  | 0.32               | 0.47  | 0.33               | 0.49  |      |       |
| Cv coefficient (50°C/100°C)                            | 1                                 | 1     | 1     | 1     | 1                  | 1     | 1                  | 1     | I    |       |
| Forced outage (%)                                      | 3                                 | 3     | 3     | 3     | 3                  | 3     | 3                  | 3     |      |       |
| Planned outage (weeks per year)                        | 3.0                               | 3.0   | 3.0   | 3.0   | 2.6                | 3.5   | 2.3                | 3.8   |      |       |
| Technical lifetime (years)                             | 25                                | 25    | 25    | 25    | 20                 | 35    | 20                 | 35    |      | 1     |
| Construction time (years)                              | 5                                 | 5     | 5     | 5     | 4.5                | 5.5   | 4                  | 5.5   |      | 1     |
| Space requirement (1000 m <sup>2</sup> /MWe)           | 0.09                              | 0.09  | 0.09  | 0.09  | 0.08               | 0.10  | 0.07               | 0.11  |      | 1     |
| <b>Regulation ability</b>                              |                                   |       |       |       |                    |       |                    |       |      |       |
| Primary regulation (% per 30 seconds)                  | 2                                 | 2     | 2     | 2     | 2                  | 2     | 2                  | 2     |      |       |
| Secondary regulation (% per minute)                    | 4                                 | 4     | 4     | 4     | 4                  | 4     | 4                  | 4     | D    | 1     |
| Minimum load (% of full load)                          | 45                                | 45    | 45    | 45    | 45                 | 45    | 45                 | 45    |      |       |
| Warm start-up time (hours)                             | 2                                 | 2     | 2     | 2     | 2                  | 2     | 2                  | 2     | E+G  | 1     |
| Cold start-up time (hours)                             | 12                                | 12    | 12    | 12    | 12                 | 12    | 12                 | 12    |      | 1     |
| <b>Environment</b>                                     |                                   |       |       |       |                    |       |                    |       |      |       |
| SO <sub>2</sub> (degree of desulphuring, %)            | 98.0                              | 98.0  | 98.0  | 98.0  | 94.9               | 99.0  | 98.0               | 99.0  | F    | 1,2,3 |
| NO <sub>x</sub> (g per GJ fuel)                        | 30                                | 20    | 20    | 10    | 10                 | 30    | 10                 | 20    | F    | 1,2,3 |
| CH <sub>4</sub> (g per GJ fuel)                        | 3                                 | 2     | 2     | 1     | 1                  | 3     | 0                  | 3     | F    | 1,2,3 |
| N <sub>2</sub> O (g per GJ fuel)                       | 10                                | 8     | 6     | 5     | 5                  | 10    | 3                  | 10    | F    | 1,2,3 |
| Particles (g per GJ fuel)                              | 0.3                               | 0.3   | 0.3   | 0.3   | 0.1                | 2.0   | 0.1                | 1.0   | F    | 1,2,3 |
| <b>Financial data</b>                                  |                                   |       |       |       |                    |       |                    |       |      |       |
| Nominal investment (M€/MWe)                            | 3.6                               | 3.5   | 3.3   | 3.2   | 3.0                | 4.2   | 2.5                | 4.3   | J, K | 1     |
| - of which equipment                                   | 2.4                               | 2.3   | 2.2   | 2.1   | 1.9                | 2.8   | 1.6                | 2.8   | K    |       |

|  |         |         |        |        |        |         |        |         |      |   |
|--|---------|---------|--------|--------|--------|---------|--------|---------|------|---|
| - of which installation  | 1.3     | 1.2     | 1.2    | 1.1    | 1.1    | 1.5     | 0.9    | 1.5     | K    |   |
| Fixed O&M (€/MWe/year)   | 105,000 | 102,000 | 96,000 | 90,000 | 86,000 | 120,000 | 69,000 | 118,000 |      |   |
| Variable O&M (€/MWh_e)   | 4.6     | 4.6     | 4.6    | 4.7    | 3.3    | 5.2     | 3.0    | 5.7     | L    |   |
| <b>Technology specific data</b>  |         |         |        |        |        |         |        |         |      |   |
| Steam reheat   | None    | None    | None   | None   | None   | Yes     | None   | Yes     |      |   |
| Flue gas condensation  | Yes     | Yes     | Yes    | Yes    | No     | Yes     | No     | Yes     | C    |   |
| Combustion air humidification  | Yes     | Yes     | Yes    | Yes    | No     | Yes     | No     | Yes     | C    |   |
| Output of recovered condensate (tonne/MWh_input)                         | 0.19    | 0.19    | 0.19   | 0.19   | 0.00   | 0.19    | 0.00   | 0.19    | C, L |   |
| Nominal investment (M€/MW fuel input)                                    | 1.03    | 1.00    | 0.95   | 0.88   | 0.85   | 1.20    | 0.70   | 1.21    | J, K | 1 |
| - of which equipment   | 0.66    | 0.65    | 0.62   | 0.58   | 0.54   | 0.78    | 0.44   | 0.79    | K    |   |
| - of which installation  | 0.36    | 0.35    | 0.34   | 0.30   | 0.31   | 0.42    | 0.25   | 0.42    | K    |   |
| Fixed O&M (€/MW input/year)  | 29,500  | 28,800  | 27,300 | 25,100 | 24,300 | 33,900  | 19,100 | 32,900  |      |   |
| Variable O&M (€/MWh input)   | 1.3     | 1.3     | 1.3    | 1.3    | 1.0    | 1.5     | 0.8    | 1.6     | L    |   |
| Fuel storage specific cost in excess of 2 days (M€/MW_input/storage day) | 0.010   | 0.010   | 0.009  | 0.008  | 0.009  | 0.012   | 0.007  | 0.012   | K    |   |
| Heat efficiency, net (%), name plate                                     | 80.9    | 81.1    | 81.0   | 81.5   | 46     | 84      | 45     | 83      | B, H | 1 |
| Heat efficiency, net (%), annual average                                 | 82.3    | 82.6    | 82.5   | 82.9   | 48     | 86      | 48     | 85      | B, H | 1 |
| Additional heat potential with heat pumps (% of thermal input)           | 4.6     | 4.5     | 4.5    | 4.5    | 4      | 28      | 4      | 28      | C    | 1 |

**Notes:**

- A The boiler in the plant is a circulating fluid bed boiler (CFB) producing steam to be used in a subsequent backpressure steam turbine without steam re-heat. The system is optimised at DH return temperature 50°C and flow 100°C.
- B Through a turbine by-pass all the produced steam energy can be used for District Heat production. It can be assumed that all electricity production is converted into heat production in by-pass.
- C Additional heat potential for heat pump is the flue gas condensation potential remaining after the direct condensation stage (condensation by heat exchange with DH-water). Direct condensation and combustion air humidification are included in all cases except in lower/upper range of 2020 and 2050.
- D Secondary regulation normally relates to power production; for this type of plant it may not be of importance since load will normally follow heat consumption.
- E A limiting factor for the hot and cold start-up times is the size of the hot water tank (deaerator). Warm start-up time is particularly low for fluid bed types of plants.
- F It is to be expected that the NOx level is low from the CFB, and that the necessary DeNOx can be accomplished using SNCR, except where anticipated emission levels are below 20 g/GJ, in which case SCR is used. From 2017 NOx (and other emissions) must fulfill the BAT\_AEL values of the LCP BREF note.

- G Warm start is starting with a glowing bed and a warm deaerator.
- H The total efficiency is the sum of electricity efficiency and heat efficiency, applicable for "name plate" and "annual average", respectively. The "annual average" electricity efficiency is lower than "name plate" due to turbine outages and other incidents. The resulting lost power production is recovered as heat. This is why "annual average" heat efficiency is higher than "name plate" heat. Efficiencies refer to lower heating value. The parasitic electricity consumption has been subtracted in the listed electricity efficiencies.
- I The Cv value does not exist for plants with a backpressure turbine or an ORC turbine
- J Investment applies to a standard plant. There could be cost related to the actual project or site that adds to the total investment, e.g. additional fuel storage, facilities for chipping of logs, conditions for foundation and harbour facilities.  
Financial data and Technological specific data are essentially the total cost either divided by the electric net capacity, i.e. corresponding to the indicated name plate efficiencies, or by the thermal input. This is to indicate that new plants may not fully take advantage of the technical capabilities for full electricity production capacity. The two cost for electricity and thermal input, respectively, are not to be added up!
- K Note that investments include only two days fuel storage, and more may be optimal, depending on fuel supply opportunities and heat supply obligations, amongst other things.  
The additional investment is listed in the bottom row.
- L Variable O&M cost includes consumables (for FGT etc.), disposal of residues and maintenance cost. Cost for disposal of recovered flue gas condensate is included at a rate of 1.0 €/tonne of condensate. Electricity consumption is not included for CHP, and revenues from sale of electricity and heat are not included. Taxes are not included.

### References

- 1 Rambøll Danmark, internal evaluation based on either existing projects, supplier offers, or pre-project studies.
- 2 EU-commission, LCP BREF note. Thierry Lecomte, José Félix Ferrería de la Fuente, Frederik Neuwahl, Michele Canova, Antoine Pinasseau, Ivan Jankov, Thomas Brinkmann, Serge Roudier, Luis Delgado Sancho; Best Available Techniques (BAT) Reference Document for Large Combustion Plants; EUR 28836 EN; doi:10.2760/949
- 3 Estimated from emission factors of 2006: 81 g/GJ NO<sub>x</sub>, 1.9 g/GJ for SO<sub>2</sub>, <1 g/GJ for CH<sub>4</sub>, 0.8 g/GJ for N<sub>2</sub>O, 10 g/GJ for Particles; cf. Nielsen, M., Nielsen, O.-K. & Thomsen, M. 2010: Emissions from decentralised CHP plants 2007 - Energinet.dk Environmental project no. 07/1882. Project report 5 – Emission factors and emission inventory for decentralised CHP production. National Environmental Research Institute, Aarhus University. 113 pp. – NERI Technical report No. 786. <http://www.dmu.dk/Pub/FR786.pdf>.

## Data sheets Wood Chips CHP, large, extraction

| Technology                                      | Large Wood Chips CHP, 600 MW feed, Extraction |        |        |        |        |                       |        |                       |        |      |        |
|---|---|--------|--------|--------|--------|-----------------------|--------|-----------------------|--------|------|--------|
|   | 2015<br>(No FGC)                              | 2015   | 2020   | 2030   | 2050   | Uncertainty<br>(2020) |        | Uncertainty<br>(2050) |        | Note | Ref    |
| Energy/technical data                           |   |        |        |        |        | Lower                 | Upper  | Lower                 | Upper  |      |        |
| Generating capacity for one unit (MWe)          | 258.2   | 257.7  | 258.2  | 259.7  | 248.6  | 238.8                 | 258.6  | 242.6                 | 261.3  | A    |        |
| Electricity efficiency, net (%), name plate     | 43  | 43     | 43     | 43.2   | 41.4   | 39.8                  | 43.1   | 40.4                  | 43.6   | A, H | 1      |
| Electricity efficiency, net (%), annual average | 40.9  | 40.8   | 40.9   | 41     | 39.4   | 37.8                  | 41     | 38.5                  | 41.4   | A, H | 1      |
| Cb coefficient (50°C/100°C)                     | 0.59  | 0.44   | 0.45   | 0.42   | 0.4    | 0.42                  | 0.41   | 0.43                  | 0.44   |      |        |
| Cv coefficient (50°C/100°C)                     | 0.18  | 0.14   | 0.14   | 0.14   | 0.13   | 0.13                  | 0.13   | 0.13                  | 0.14   |      |        |
| Forced outage (%)                               | 3   | 3      | 3      | 3      | 3      | 3                     | 3      | 3                     | 3      |      |        |
| Planned outage (weeks per year)                 | 3   | 3      | 3      | 3      | 3      | 2.6                   | 3.5    | 2.3                   | 3.8    |      |        |
| Technical lifetime (years)                      | 25  | 25     | 25     | 25     | 25     | 25                    | 25     | 25                    | 25     |      | 1      |
| Construction time (years)                       | 5   | 5      | 5      | 5      | 5      | 5                     | 5      | 5                     | 5      |      | 1      |
| Space requirement (1000 m2/MWe)                 | 0.06  | 0.06   | 0.06   | 0.06   | 0.06   | 0.06                  | 0.06   | 0.06                  | 0.06   |      | 1      |
| <b>Regulation ability</b>                       |   |        |        |        |        |                       |        |                       |        |      |        |
| Primary regulation (% per 30 seconds)           | 2   | 2      | 2      | 2      | 2      | 2                     | 2      | 2                     | 2      |      |        |
| Secondary regulation (% per minute)             | 4   | 4      | 4      | 4      | 4      | 4                     | 4      | 4                     | 4      | D    | 1      |
| Minimum load (% of full load)                   | 45  | 45     | 45     | 45     | 45     | 45                    | 45     | 45                    | 45     |      |        |
| Warm start-up time (hours)                      | 2   | 2      | 2      | 2      | 2      | 2                     | 2      | 2                     | 2      | E+G  | 1      |
| Cold start-up time (hours)                      | 12  | 12     | 12     | 12     | 12     | 12                    | 12     | 12                    | 12     |      | 1      |
| <b>Environment</b>                              |   |        |        |        |        |                       |        |                       |        |      |        |
| SO2 (degree of desulphuring, %)                 | 97.5  | 97.5   | 97.5   | 97.5   | 97.5   | 97.5                  | 97.5   | 97.5                  | 97.5   | F    | 1, 2,3 |
| NOX (g per GJ fuel)                             | 30  | 30     | 20     | 20     | 10     | 10                    | 30     | 10                    | 20     | F    | 1, 2,3 |
| CH4 (g per GJ fuel)                             | 3   | 3      | 2      | 2      | 1      | 1                     | 3      | 0                     | 3      | F    | 1, 2,3 |
| N2O (g per GJ fuel)                             | 10  | 10     | 8      | 6      | 5      | 5                     | 10     | 3                     | 10     | F    | 1, 2,3 |
| Particles (g per GJ fuel)                       | 0.3   | 0.3    | 0.3    | 0.3    | 0.3    | 0.1                   | 2      | 0.1                   | 1      | F    | 1, 2,3 |
| <b>Financial data</b>                           |   |        |        |        |        |                       |        |                       |        |      |        |
| Nominal investment (M€/MWe)                     | 2.5   | 2.6    | 2.5    | 2.4    | 2.3    | 2.4                   | 3.1    | 2.2                   | 3.3    | J, K | 1      |
| - of which equipment                            | 1.6   | 1.6    | 1.6    | 1.5    | 1.4    | 1.5                   | 1.9    | 1.4                   | 2.1    | K    |        |
| - of which installation                         | 0.9   | 1      | 0.9    | 0.9    | 0.8    | 0.8                   | 1.1    | 0.8                   | 1.2    | K    |        |
| Fixed O&M (€/MWe/year)                          | 69 000  | 70 000 | 69 000 | 64 000 | 62 000 | 66 000                | 80 000 | 57 000                | 79 000 |      |        |
| Variable O&M (€/MWeh)                           | 2.6   | 2.6    | 2.6    | 2.6    | 2.7    | 2.8                   | 2.6    | 2.7                   | 2.5    | L    |        |
| <b>Technology specific data</b>                 |   |        |        |        |        |                       |        |                       |        |      |        |

|  |           |           |           |           |           |           |           |           |           |      |   |
|--|-----------|-----------|-----------|-----------|-----------|-----------|-----------|-----------|-----------|------|---|
| Steam reheat   | Yes       | Yes       | Yes       | Yes       | Yes       | Yes       | Yes       | Yes       | Yes       |      |   |
| Flue gas condensation  | No        | Yes       | Yes       | Yes       | Yes       | Yes       | Yes       | Yes       | Yes       |      |   |
| Combustion air humidification                                      | No        | No        | No        | No        | No        | No        | Yes       | No        | Yes       |      |   |
| Additional heat potential with heat pumps (%of thermal input)      | -         | 4.1       | 4.1       | 4.1       | 4.1       | 4.1       | 4.1       | 4.1       | 4.1       | C    | 1 |
| Nominal investment (M€/MWth) (fuel input)                          | 1.09      | 1.1       | 1.08      | 1.02      | 0.94      | 0.94      | 1.32      | 0.88      | 1.44      | J, K | 1 |
| - of which equipment   | 0.69      | 0.69      | 0.67      | 0.63      | 0.59      | 0.59      | 0.84      | 0.55      | 0.92      | K    |   |
| - of which installation  | 0.4       | 0.42      | 0.41      | 0.4       | 0.36      | 0.35      | 0.48      | 0.33      | 0.52      | K    |   |
| Fixed O&M (€/MW input/year)  | 30<br>200 | 30<br>200 | 29<br>500 | 27<br>900 | 25<br>500 | 26<br>400 | 34<br>400 | 23<br>200 | 34<br>200 |      |   |
| Variable O&M (€/MWh input)   | 1.11      | 1.11      | 1.11      | 1.11      | 1.11      | 1.11      | 1.11      | 1.11      | 1.11      | L    |   |
| Fuel storage specific cost in excess of 2 days (M€/MW/storage day) | 0.02      | 0.02      | 0.02      | 0.02      | 0.02      | 0.02      | 0.02      | 0.02      | 0.02      | K    |   |

### References:

- 1 Rambøll Danmark, internal evaluation based on either existing projects, supplier offers, or pre-project studies.
- 2 EU-commission, LCP BREF note. Thierry Lecomte, José Félix Ferrería de la Fuente, Frederik Neuwahl, Michele Canova, Antoine Pinasseau, Ivan Jankov, Thomas Brinkmann, Serge Roudier, Luis Delgado Sancho; Best Available Techniques (BAT) Reference Document for Large Combustion Plants; EUR 28836 EN; doi:10.2760/949
- 3 Estimated from emission factors of 2006: 81 g/GJ NO<sub>x</sub>, 1.9 g/GJ for SO<sub>2</sub>, <1 g/GJ for CH<sub>4</sub>, 0.8 g/GJ for N<sub>2</sub>O, 10 g/GJ for Particles; cf. Nielsen, M., Nielsen, O.-K. & Thomsen, M. 2010: Emissions from decentralised CHP plants 2007 - Energinet.dk Environmental project no. 07/1882. Project report 5 – Emission factors and emission inventory for decentralised CHP production. National Environmental Research Institute, Aarhus University. 113 pp. – NERI Technical report No. 786. <http://www.dmu.dk/Pub/FR786.pdf>.

### Notes:

- A The boiler in the plant is a circulating fluid bed boiler (CFB) producing steam to be used in a subsequent extraction steam turbine with steam re-heat.
- B -
- C Additional heat potential for heat pump is the flue gas condensation potential remaining after the direct condensation stage (condensation by heat exchange with DH-water). This comes in addition to direct condensation that may yield 22% (of thermal input) when operated with combustion air humidification and assuming 50 °C DH return temperature. DH water may be heated in two (or more) stages, first stage being direct condensation (at hardly any drop in electricity output), second stage extraction steam with drop in electricity output, cf. the Cv-value.
- D Secondary regulation normally relates to power production.
- E A limiting factor for the hot and cold start-up times is the size of the hot water tank (deaerator). Warm start-up time is particularly low for fluid bed types of plants.
- F It is to be expected that the NO<sub>x</sub> level is low from the CFB, and that the necessary DeNO<sub>x</sub> can be accomplished using SNCR, except where anticipated emission levels are below 20 g/GJ, in which case SCR is used. From 2017 NO<sub>x</sub> (and other emissions) must fulfil the BAT\_AEL values of the LCP BREF note.
- G Warm start is starting with a glowing bed and a warm deaerator.
- H The electricity efficiency is applicable for "name plate" and "annual average", respectively. The "annual average" electricity efficiency is lower than "name plate" due to the effects of load variations, turbine outages and other incidents. Efficiencies refer to thermal input by lower heating value. The parasitic electricity consumption has been subtracted in the listed electricity efficiencies.



I -

J Investment applies to a standard plant. There could be cost related to the actual project or site that adds to the total investment, e.g. additional fuel storage, facilities for chipping of logs, conditions for foundation and harbour facilities.

Financial data and Technological specific data are essentially the total cost either divided by the electric net capacity, i.e. corresponding to the indicated name plate efficiencies, or by the thermal input. This is to indicate that new plants may not fully take advantage of the technical capabilities for full electricity production capacity. The two cost for electricity and thermal input, respectively, are not to be added up!

K Note that investments include only two days fuel storage, and more may be optimal, depending on fuel supply opportunities and energy supply obligations, amongst other things. The additional investment is listed in the bottom row.

L Variable O&M cost includes consumables (for FGT etc.), disposal of residues and maintenance cost. Cost for disposal of recovered flue gas condensate, if applicable, is not included. Electricity consumption is not included as a cost for CHP, and revenues from sale of electricity and heat are not included. Taxes are not included.

## Data sheets Wood Pellets CHP, small

| Technology   | Small Wood Pellets CHP, 20 MW feed |         |         |         |                    |         |                    |         |       |     |
|--|------------------------------------|---------|---------|---------|--------------------|---------|--------------------|---------|-------|-----|
|  | 2015                               | 2020    | 2030    | 2050    | Uncertainty (2020) |         | Uncertainty (2050) |         | Note  | Ref |
| <b>Energy/technical data</b>                                 |                                    |         |         |         | Lower              | Upper   | Lower              | Upper   |       |     |
| Generating capacity for one unit (MWe)                       | 3.1                                | 3.1     | 3.1     | 3.0     | 3.0                | 3.1     | 3.0                | 3.1     | A     |     |
| Electricity efficiency, net (%), name plate                  | 15.4                               | 15.4    | 15.4    | 15.2    | 14                 | 16      | 14                 | 16      | A, H  | 1   |
| Electricity efficiency, net (%), annual average              | 14.6                               | 14.6    | 14.7    | 14.4    | 13                 | 15      | 13                 | 15      | A, H  | 1   |
| Auxiliary electricity consumption (% of thermal input)       | 2.3                                | 2.3     | 2.3     | 2.3     | 1.8                | 2.5     | 1.4                | 2.5     |       | 1   |
| Cb coefficient (40°C/80°C)                                   | 0.18                               | 0.18    | 0.18    | 0.18    | 0.18               | 0.19    | 0.18               | 0.19    |       |     |
| Cv coefficient (40°C/80°C)                                   | 1                                  | 1       | 1       | 1       | 1                  | 1       | 1                  | 1       | I, M  |     |
| Forced outage (%)  | 3                                  | 3       | 3       | 3       | 3                  | 3       | 3                  | 3       |       |     |
| Planned outage (weeks per year)                              | 3.0                                | 3.0     | 3.0     | 3.0     | 2.6                | 3.5     | 2.3                | 3.8     |       |     |
| Technical lifetime (years)                                   | 25                                 | 25      | 25      | 25      | 20                 | 35      | 20                 | 35      |       | 1   |
| Construction time (years)                                    | 1                                  | 1       | 1       | 1       | 0.5                | 1.5     | 0.5                | 1.5     |       | 1   |
| Space requirement (1000 m <sup>2</sup> /MWe)                 | 0.5                                | 0.5     | 0.5     | 0.5     | 0.4                | 0.6     | 0.4                | 0.6     |       |     |
| <b>Regulation ability</b>                                    |                                    |         |         |         |                    |         |                    |         |       |     |
| Primary regulation (% per 30 seconds)                        | NA                                 | NA      | NA      | NA      | NA                 | NA      | NA                 | NA      |       |     |
| Secondary regulation (% per minute)                          | 10                                 | 10      | 10      | 10      | 10                 | 10      | 10                 | 10      | D     | 1   |
| Minimum load (% of full load)                                | 20                                 | 20      | 20      | 20      | 20                 | 20      | 20                 | 20      | D     | 1   |
| Warm start-up time (hours)                                   | 0.25                               | 0.25    | 0.25    | 0.25    | 0.25               | 0.25    | 0.25               | 0.25    | G     | 1   |
| Cold start-up time (hours)                                   | 0.5                                | 0.5     | 0.5     | 0.5     | 0.5                | 0.5     | 0.5                | 0.5     |       | 1   |
| <b>Environment</b>   |                                    |         |         |         |                    |         |                    |         |       |     |
| SO <sub>2</sub> (degree of desulphuring, %)                  | 98.3                               | 98.3    | 98.3    | 98.3    | 95.6               | 99.1    | 98.3               | 99.1    | F     | 1   |
| NO <sub>x</sub> (g per GJ fuel)                              | 90                                 | 50      | 40      | 30      | 40                 | 70      | 20                 | 40      | F     | 1   |
| CH <sub>4</sub> (g per GJ fuel)                              | 0                                  | 0       | 0       | 0       | 0                  | 0       | 0                  | 0       | F     | 1   |
| N <sub>2</sub> O (g per GJ fuel)                             | 1                                  | 1       | 1       | 1       | 1                  | 3       | 0                  | 1       | F     | 1   |
| Particles (g per GJ fuel)                                    | 2.0                                | 0.3     | 0.3     | 0.3     | 0.1                | 2.0     | 0.1                | 1.0     | F     | 1   |
| <b>Financial data</b>  |                                    |         |         |         |                    |         |                    |         |       |     |
| Nominal investment (M€/MWe)                                  | 6.2                                | 6.1     | 5.7     | 5.5     | 5.3                | 7.1     | 4.4                | 7.6     | E,J,K | 1   |
| - of which equipment   | 4.1                                | 4.0     | 3.8     | 3.7     | 3.4                | 4.7     | 2.9                | 5.0     | K     |     |
| - of which installation                                      | 2.2                                | 2.1     | 2.0     | 1.8     | 1.8                | 2.5     | 1.5                | 2.5     | K     |     |
| Fixed O&M (€/MWe/year)                                       | 275,000                            | 271,000 | 261,000 | 253,000 | 232,000            | 314,000 | 192,000            | 325,000 |       |     |
| Variable O&M (€/MWh <sub>e</sub> )                           | 3.9                                | 3.9     | 3.9     | 3.9     | 3.0                | 4.4     | 2.7                | 4.8     | L     |     |
| <b>Technology specific data</b>                              |                                    |         |         |         |                    |         |                    |         |       |     |
| Steam reheat   | None                               | None    | None    | None    | None               | None    | None               | None    |       |     |
| Flue gas condensation  | Yes                                | Yes     | Yes     | Yes     | No                 | Yes     | No                 | Yes     | C     |     |
| Combustion air humidification                                | Yes                                | Yes     | Yes     | Yes     | No                 | Yes     | No                 | Yes     | C     |     |
| Output of recovered condensate (tonne/MWh <sub>input</sub> ) | 0.06                               | 0.06    | 0.06    | 0.06    | 0.00               | 0.06    | 0.00               | 0.06    | C,L   |     |
| Nominal investment (M€/MW fuel input)                        | 0.96                               | 0.93    | 0.89    | 0.84    | 0.81               | 1.10    | 0.67               | 1.15    | E,J,K | 1   |
| - of which equipment   | 0.63                               | 0.61    | 0.58    | 0.56    | 0.53               | 0.72    | 0.43               | 0.76    | K     |     |

|  |        |        |        |        |        |        |        |        |      |   |
|--|--------|--------|--------|--------|--------|--------|--------|--------|------|---|
| - of which installation  | 0.33   | 0.32   | 0.31   | 0.28   | 0.28   | 0.38   | 0.23   | 0.39   | K    |   |
| Fixed O&M (€/MW input/year)  | 42,500 | 41,700 | 40,300 | 38,500 | 35,700 | 48,400 | 29,200 | 49,500 |      |   |
| Variable O&M (€/MWh input)   | 0.60   | 0.60   | 0.60   | 0.60   | 0.46   | 0.68   | 0.41   | 0.74   | L    |   |
| Fuel storage specific cost in excess of 2 days (M€/MW_input/storage day) | 0.004  | 0.004  | 0.004  | 0.003  | 0.003  | 0.005  | 0.003  | 0.005  | K    |   |
| Heat efficiency, net (%), name plate                                     | 83.4   | 83.4   | 83.4   | 83.6   | 72     | 85     | 71     | 85     | B, H | 1 |
| Heat efficiency, net (%), annual average                                 | 84.2   | 84.2   | 84.2   | 84.4   | 74     | 86     | 72     | 86     | B, H | 1 |
| Additional heat potential with heat pumps (% of thermal input)           | 1.7    | 1.7    | 1.7    | 1.7    | 1      | 11     | 1      | 13     | C    | 1 |

**Notes:**

- A The plant is directly producing hot water for District Heating by burning fuel on a grate. The electric power is produced by an ORC module (Organic Rankine Cycle; Waste Heat Recovery - WHR). Refer for instance to the following link for further information about technology and suppliers: [http://www.enova.no/upload\\_images/36AC689098414B05A7112FA2EE985BDA.pdf](http://www.enova.no/upload_images/36AC689098414B05A7112FA2EE985BDA.pdf) This is low temperature and low efficiency electric power but at an affordable price.
- The system is optimised at DH return temperature 40°C and flow 80°C.
- B Boilers up to 20 MW fuel input for hot water production are more or less standardized products with a high degree of fuel flexibility (type of biomass, humidity etc.)
- C Since wood pellets are relatively dry there is often only a minor efficiency advantage in using flue gas condensation. There is though an environmental advantage in having a scrubber in the flue gas stream. Direct condensation and combustion air humidification are included in all cases except in lower/upper range of 2020 and 2050.
- D Since wood pellets are relatively dry there is often only a minor efficiency advantage in using flue gas condensation. There is though an environmental advantage in having a scrubber in the flue gas stream. Direct condensation and combustion air humidification are included in all cases except in lower/upper ranges of 2020 and 2050.
- E Since electricity generation is only a secondary objective for minor heat producers, it may make more sense to relate the total investment only to the thermal input.
- F Emissions shall comply with the order of the Danish EPA no 1535 of 2019 (Bekendtgørelse om miljøkrav for mellemstore fyringsanlæg), implementing the Medium Combustion Directive, Directive (EU) 2015/2193 of the European Parliament and of the Council of 25 November 2015 on the limitation of emissions of certain pollutants into the air from medium combustion plants..  
It is anticipated that for the smaller units the supplier has an SNCR solution to reduce NOx emissions sufficiently. However, to reach NOx-levels below 40 g/GJ SCR is assumed.
- G Warm start is starting with a glowing fuel layer on the grate.
- H The total efficiency is the sum of electricity efficiency and heat efficiency, applicable for "name plate" and "annual average", respectively. The "annual average" electricity efficiency is lower than "name plate" due to turbine outages and other incidents. The resulting lost power production is recovered as heat. This is why "annual average" heat efficiency is higher than "name plate" heat. Efficiencies refer to lower heating value. The parasitic electricity consumption has been subtracted in the listed electricity efficiencies.
- I The Cv value does not exist for plants with a back-pressure turbine or an ORC turbine
- J Investment applies to a standard plant. There could be cost related to the actual project or site that adds to the total investment, e.g. additional fuel storage, facilities for chipping of logs, conditions for foundation and harbour facilities.  
Financial data and Technological specific data are essentially the total cost either divided by the electric net capacity, i.e. corresponding to the indicated name plate efficiencies, or by the thermal input. This is to indicate that new plants may not fully take advantage of the technical capabilities for full electricity production capacity. The two cost for electricity and thermal input, respectively, are not to be added up!
- K Note that investments include only two days fuel storage, and more may be optimal, depending on fuel supply opportunities and heat supply obligations, amongst other things.  
The additional investment is listed in the bottom row.
- L Variable O&M cost includes consumables (for FGT etc.), disposal of residues and maintenance cost. Cost for disposal of recovered flue gas condensate is included at a rate of 1.0 €/tonne of condensate. Electricity consumption is not included for CHP, and revenues from sale of electricity and heat are not included. Taxes are not included.

Through a turbine by-pass all the produced steam energy can be used for District Heat production. It can be assumed that all electricity production is converted into heat production in by-pass.

### References

- 1 Rambøll Denmark, internal evaluation based on either existing projects, supplier offers, or pre-project studies.

## Data sheets Wood Pellets CHP, medium

| Technology   | Medium Wood Pellets CHP, 80 MW feed |         |         |         |                    |         |                    |         | Note    | Ref |
|--|-------------------------------------|---------|---------|---------|--------------------|---------|--------------------|---------|---------|-----|
|  | 2015                                | 2020    | 2030    | 2050    | Uncertainty (2020) |         | Uncertainty (2050) |         |         |     |
| Energy/technical data  |                                     |         |         |         | Lower              | Upper   | Lower              | Upper   |         |     |
| Generating capacity for one unit (MWe)                       | 24.7                                | 24.7    | 24.7    | 24.4    | 23.8               | 33.4    | 23.8               | 34.0    | A       |     |
| Electricity efficiency, net (%), name plate                  | 30.8                                | 30.8    | 30.9    | 30.5    | 29                 | 42      | 29                 | 43      | A, H, F | 1   |
| Electricity efficiency, net (%), annual average              | 29.3                                | 29.3    | 29.4    | 29.0    | 26                 | 40      | 26                 | 41      | A, H, F | 1   |
| Auxiliary electricity consumption (% of thermal input)       | 2.5                                 | 2.5     | 2.5     | 2.5     | 1.9                | 2.9     | 1.5                | 3.1     |         | 1   |
| Cb coefficient (40°C/80°C)                                   | 0.46                                | 0.46    | 0.46    | 0.45    | 0.44               | 0.62    | 0.44               | 0.63    |         |     |
| Cv coefficient (40°C/80°C)                                   | 1                                   | 1       | 1       | 1       | 1                  | 1       | 1                  | 1       | I       |     |
| Forced outage (%)  | 3                                   | 3       | 3       | 3       | 3                  | 3       | 3                  | 3       |         |     |
| Planned outage (weeks per year)                              | 3.0                                 | 3.0     | 3.0     | 3.0     | 2.6                | 3.5     | 2.3                | 3.8     |         |     |
| Technical lifetime (years)                                   | 25                                  | 25      | 25      | 25      | 20                 | 35      | 20                 | 35      |         | 1   |
| Construction time (years)                                    | 2.5                                 | 2.5     | 2.5     | 2.5     | 2                  | 3       | 1.5                | 3       |         | 1   |
| Space requirement (1000 m <sup>2</sup> /MWe)                 | 0.18                                | 0.18    | 0.18    | 0.18    | 0.16               | 0.21    | 0.14               | 0.23    |         |     |
| <b>Regulation ability</b>                                    |                                     |         |         |         |                    |         |                    |         |         |     |
| Primary regulation (% per 30 seconds)                        | NA                                  | NA      | NA      | NA      | NA                 | NA      | NA                 | NA      |         |     |
| Secondary regulation (% per minute)                          | 10                                  | 10      | 10      | 10      | 10                 | 10      | 10                 | 10      | D       | 1   |
| Minimum load (% of full load)                                | 15                                  | 15      | 15      | 15      | 15                 | 15      | 15                 | 15      |         |     |
| Warm start-up time (hours)                                   | 0.25                                | 0.25    | 0.25    | 0.25    | 0.25               | 0.25    | 0.25               | 0.25    | E       | 1   |
| Cold start-up time (hours)                                   | 8                                   | 8       | 8       | 8       | 8                  | 8       | 8                  | 8       |         | 1   |
| <b>Environment</b>   |                                     |         |         |         |                    |         |                    |         |         |     |
| SO <sub>2</sub> (degree of desulphuring, %)                  | 98.3                                | 98.3    | 98.3    | 98.3    | 95.6               | 99.1    | 98.3               | 99.1    | F       | 1,2 |
| NO <sub>x</sub> (g per GJ fuel)                              | 80                                  | 50      | 40      | 20      | 40                 | 50      | 10                 | 40      | F       | 1,2 |
| CH <sub>4</sub> (g per GJ fuel)                              | 0                                   | 0       | 0       | 0       | 0                  | 0       | 0                  | 0       | F       | 1,2 |
| N <sub>2</sub> O (g per GJ fuel)                             | 1                                   | 1       | 1       | 1       | 1                  | 3       | 0                  | 1       | F       | 1,2 |
| Particles (g per GJ fuel)                                    | 2.0                                 | 0.3     | 0.3     | 0.3     | 0.1                | 2.0     | 0.1                | 1.0     | F       | 1,2 |
| <b>Financial data</b>  |                                     |         |         |         |                    |         |                    |         |         |     |
| Nominal investment (M€/MWe)                                  | 3.1                                 | 3.0     | 2.9     | 2.7     | 2.5                | 3.5     | 2.1                | 3.7     | J,K     | 1   |
| - of which equipment   | 2.0                                 | 1.9     | 1.8     | 1.8     | 1.6                | 2.3     | 1.3                | 2.4     | K       |     |
| - of which installation                                      | 1.1                                 | 1.1     | 1.0     | 0.9     | 0.9                | 1.3     | 0.8                | 1.3     | K       |     |
| Fixed O&M (€/MWe/year)                                       | 128,000                             | 124,000 | 117,000 | 108,000 | 104,000            | 144,000 | 81,000             | 140,000 |         |     |
| Variable O&M (€/MWh <sub>e</sub> )                           | 1.9                                 | 1.9     | 1.9     | 1.9     | 1.5                | 2.1     | 1.3                | 2.3     | L       |     |
| <b>Technology specific data</b>                              |                                     |         |         |         |                    |         |                    |         |         |     |
| Steam reheat   | None                                | None    | None    | None    | None               | Yes     | None               | Yes     |         |     |
| Flue gas condensation  | Yes                                 | Yes     | Yes     | Yes     | No                 | Yes     | No                 | Yes     | C       |     |
| Combustion air humidification                                | Yes                                 | Yes     | Yes     | Yes     | No                 | Yes     | No                 | Yes     | C       |     |
| Output of recovered condensate (tonne/MWh <sub>input</sub> ) | 0.06                                | 0.06    | 0.06    | 0.06    | 0.00               | 0.06    | 0.00               | 0.06    | C,L     |     |
| Nominal investment (M€/MW fuel input)                        | 0.95                                | 0.93    | 0.88    | 0.83    | 0.77               | 1.09    | 0.63               | 1.13    | J,K     | 1   |

|  |        |        |        |        |        |        |        |        |         |   |
|--|--------|--------|--------|--------|--------|--------|--------|--------|---------|---|
| - of which equipment   | 0.61   | 0.59   | 0.56   | 0.54   | 0.48   | 0.70   | 0.39   | 0.73   | K       |   |
| - of which installation  | 0.34   | 0.33   | 0.32   | 0.29   | 0.29   | 0.40   | 0.24   | 0.40   | K       |   |
| Fixed O&M (€/MW input/year)  | 39,500 | 38,300 | 36,200 | 33,100 | 32,100 | 44,400 | 24,600 | 42,700 |         |   |
| Variable O&M (€/MWh input) *   | 0.57   | 0.57   | 0.57   | 0.57   | 0.46   | 0.66   | 0.41   | 0.71   | L       |   |
| Fuel storage specific cost in excess of 2 days (M€/MW_input/storage day) | 0.003  | 0.003  | 0.003  | 0.003  | 0.003  | 0.003  | 0.002  | 0.003  | K       |   |
| Heat efficiency, net (%), name plate                                     | 67.7   | 67.7   | 67.6   | 68.0   | 44     | 71     | 42     | 71     | A, H, F | 1 |
| Heat efficiency, net (%), annual average                                 | 69.2   | 69.2   | 69.1   | 69.6   | 47     | 73     | 45     | 73     | B, H    | 1 |
| Additional heat potential with heat pumps (% of thermal input)           | 1.7    | 1.7    | 1.7    | 1.7    | 1      | 11     | 1      | 13     | C       | 1 |

**Notes:**

- A The boiler in the plant is a suspension fired boiler producing steam to be used in a subsequent backpressure steam turbine. It is possible to pulverize wood pellets and use it for suspension firing but it has not been possible to find an appropriate reference.  
The system is optimised at DH return temperature 40°C and flow 80°C.
- B Through a turbine by-pass all the produced steam energy can be used for District Heat production. It can be assumed that all electricity production is converted into heat production in by-pass.
- C Since wood pellets are relatively dry there is often only a minor efficiency advantage in using flue gas condensation. There is though an environmental advantage in having a scrubber in the flue gas stream. Direct condensation and combustion air humidification are included in all cases except in lower/upper ranges of 2020 and 2050.
- D Secondary regulation normally relates to power production; for this type of plant it may not be of importance since load will normally follow heat consumption.
- E A limiting factor for the hot and cold start-up times is the size of the hot water tank (deaerator).
- F SNCR is assumed at NOx emissions at no less than 40 g/GJ. At lower NOx-levels it is chosen to include a tail-end SCR catalyst with slight adverse effect on electricity efficiency.
- G Warm start is starting with a glowing fuel layer on the grate and a warm deaerator.
- H The total efficiency is the sum of electricity efficiency and heat efficiency, applicable for "name plate" and "annual average", respectively. The "annual average" electricity efficiency is lower than "name plate" due to turbine outages and other incidents. The resulting lost power production is recovered as heat. This is why "annual average" heat efficiency is higher than "name plate" heat. Efficiencies refer to lower heating value. The parasitic electricity consumption has been subtracted in the listed electricity efficiencies.
- I The Cv value does not exist for plants with a backpressure turbine or an ORC turbine
- J Investment applies to a standard plant. There could be cost related to the actual project or site that adds to the total investment, e.g. additional fuel storage, facilities for chipping of logs, conditions for foundation and harbour facilities.  
Financial data and Technological specific data are essentially the total cost either divided by the electric net capacity, i.e. corresponding to the indicated name plate efficiencies, or by the thermal input. This is to indicate that new plants may not fully take advantage of the technical capabilities for full electricity production capacity. The two cost for electricity and thermal input, respectively, are not to be added up!
- K Note that investments include only two days fuel storage, and more may be optimal, depending on fuel supply opportunities and heat supply obligations, amongst other things.  
The additional investment is listed in the bottom row.
- L Variable O&M cost includes consumables (for FGT etc.), disposal of residues and maintenance cost. Cost for disposal of recovered flue gas condensate is included at a rate of 1.0 €/tonne of condensate. Electricity consumption is not included for CHP, and revenues from sale of electricity and heat are not included. Taxes are not included.

**References**

- Rambøll Danmark, internal evaluation based on either existing projects, supplier offers, or pre-project studies.
- EU-commission, LCP BREF note. Thierry Lecomte, José Félix Ferrería de la Fuente, Frederik Neuwahl, Michele Canova, Antoine Pinasseau, Ivan Jankov, Thomas Brinkmann, Serge Roudier, Luis Delgado Sancho; Best Available Techniques (BAT) Reference Document for Large Combustion Plants; EUR 28836 EN; doi:10.2760/949

## Data sheets Wood Pellets CHP, large, 40/80 °C return/forward temperature

| Technology   | Large Wood Pellets CHP, 800 MW feed |        |        |        |                    |                    |              |              |      |     |
|--|-------------------------------------|--------|--------|--------|--------------------|--------------------|--------------|--------------|------|-----|
|  | 2015                                | 2020   | 2030   | 2050   | Uncertainty (2020) | Uncertainty (2050) | Note         | Ref          |      |     |
| <b>Energy/technical data</b>                                 |                                     |        |        |        | <b>Lower</b>       | <b>Upper</b>       | <b>Lower</b> | <b>Upper</b> |      |     |
| Generating capacity for one unit (MWe)                       | 267.5                               | 268.1  | 268.8  | 268.8  | 262.4              | 348.2              | 262.4        | 348.6        | A    |     |
| Electricity efficiency, net (%), name plate                  | 33.4                                | 33.5   | 33.6   | 33.6   | 32                 | 44                 | 32           | 44           | A, H | 1   |
| Electricity efficiency, net (%), annual average              | 31.8                                | 31.8   | 31.9   | 31.9   | 29                 | 42                 | 29           | 42           | A, H | 1   |
| Auxiliary electricity consumption (% of thermal input)       | 3.3                                 | 3.3    | 3.3    | 3.3    | 2.4                | 3.7                | 1.9          | 3.7          |      | 1   |
| Cb coefficient (40°C/80°C)                                   | 0.51                                | 0.51   | 0.52   | 0.52   | 0.50               | 0.67               | 0.50         | 0.67         |      |     |
| Cv coefficient (40°C/80°C)                                   | 1                                   | 1      | 1      | 1      | 1                  | 1                  | 1            | 1            | I    |     |
| Forced outage (%)  | 3                                   | 3      | 3      | 3      | 3                  | 3                  | 3            | 3            |      |     |
| Planned outage (weeks per year)                              | 3.0                                 | 3.0    | 3.0    | 3.0    | 2.6                | 3.5                | 2.3          | 3.8          |      |     |
| Technical lifetime (years)                                   | 25                                  | 25     | 25     | 25     | 20                 | 35                 | 20           | 35           |      | 1   |
| Construction time (years)                                    | 5                                   | 5      | 5      | 5      | 4.5                | 5.5                | 4            | 5.5          |      | 1   |
| Space requirement (1000 m2/MWe)                              | 0.06                                | 0.06   | 0.06   | 0.06   | 0.05               | 0.06               | 0.04         | 0.07         |      |     |
| <b>Regulation ability</b>                                    |                                     |        |        |        |                    |                    |              |              |      |     |
| Primary regulation (% per 30 seconds)                        | 2                                   | 2      | 2      | 2      | 2                  | 2                  | 2            | 2            |      |     |
| Secondary regulation (% per minute)                          | 4                                   | 4      | 4      | 4      | 4                  | 4                  | 4            | 4            | D    | 1   |
| Minimum load (% of full load)                                | 15                                  | 15     | 15     | 15     | 15                 | 15                 | 15           | 15           |      | 1   |
| Warm start-up time (hours)                                   | 2                                   | 2      | 2      | 2      | 2                  | 2                  | 2            | 2            | G    | 1   |
| Cold start-up time (hours)                                   | 12                                  | 12     | 12     | 12     | 12                 | 12                 | 12           | 12           | E    | 1   |
| <b>Environment</b>   |                                     |        |        |        |                    |                    |              |              |      |     |
| SO <sub>2</sub> (degree of desulphuring, %)                  | 98.3                                | 98.3   | 98.3   | 98.3   | 95.6               | 99.1               | 98.3         | 99.1         |      | 1,2 |
| NO <sub>x</sub> (g per GJ fuel)                              | 20                                  | 20     | 20     | 10     | 10                 | 30                 | 10           | 20           | C+F  | 1,2 |
| CH <sub>4</sub> (g per GJ fuel)                              | 0                                   | 0      | 0      | 0      | 0                  | 0                  | 0            | 0            |      | 1,2 |
| N <sub>2</sub> O (g per GJ fuel)                             | 1                                   | 1      | 1      | 1      | 1                  | 3                  | 0            | 1            |      | 1,2 |
| Particles (g per GJ fuel)                                    | 0.3                                 | 0.3    | 0.3    | 0.3    | 0.1                | 2.0                | 0.1          | 1.0          |      | 1,2 |
| <b>Financial data</b>  |                                     |        |        |        |                    |                    |              |              |      |     |
| Nominal investment (M€/MWe)                                  | 2.31                                | 2.25   | 2.14   | 1.94   | 1.91               | 2.64               | 1.57         | 2.66         | J,K  | 1   |
| - of which equipment   | 1.29                                | 1.26   | 1.19   | 1.09   | 1.04               | 1.47               | 0.86         | 1.48         | K    |     |
| - of which installation                                      | 1.02                                | 0.99   | 0.94   | 0.85   | 0.86               | 1.17               | 0.71         | 1.18         | K    |     |
| Fixed O&M (€/MWe/year)                                       | 64,000                              | 62,000 | 59,000 | 54,000 | 53,000             | 72,000             | 42,000       | 71,000       |      |     |
| Variable O&M (€/MWh <sub>e</sub> )                           | 1.7                                 | 1.7    | 1.7    | 1.7    | 1.4                | 2.0                | 1.2          | 2.1          | L    |     |
| <b>Technology specific data</b>                              |                                     |        |        |        |                    |                    |              |              |      |     |
| Steam reheat   | None                                | None   | None   | None   | None               | Yes                | None         | Yes          |      |     |
| Flue gas condensation  | Yes                                 | Yes    | Yes    | Yes    | No                 | Yes                | No           | Yes          | C    |     |
| Combustion air humidification                                | Yes                                 | Yes    | Yes    | Yes    | No                 | Yes                | No           | Yes          | C    |     |
| Output of recovered condensate (tonne/MWh <sub>input</sub> ) | 0.06                                | 0.06   | 0.06   | 0.06   | 0.00               | 0.06               | 0.00         | 0.06         | C,L  |     |
| Nominal investment (M€/MW fuel input)                        | 0.77                                | 0.75   | 0.72   | 0.65   | 0.64               | 0.89               | 0.53         | 0.89         | J,K  | 1   |
| - of which equipment   | 0.43                                | 0.42   | 0.40   | 0.36   | 0.35               | 0.49               | 0.29         | 0.50         | K    |     |

|  |        |        |        |        |        |        |        |        |      |   |
|--|--------|--------|--------|--------|--------|--------|--------|--------|------|---|
| - of which installation  | 0.34   | 0.33   | 0.32   | 0.29   | 0.29   | 0.39   | 0.24   | 0.40   | K    |   |
| Fixed O&M (€/MW input/year)  | 21,400 | 20,900 | 20,000 | 18,300 | 17,600 | 24,300 | 14,100 | 23,900 |      |   |
| Variable O&M (€/MWh input) *   | 0.57   | 0.58   | 0.58   | 0.58   | 0.46   | 0.66   | 0.41   | 0.71   | L    |   |
| Fuel storage specific cost in excess of 2 days (M€/MW_input/storage day) | 0.0025 | 0.0024 | 0.0023 | 0.0021 | 0.0021 | 0.0029 | 0.0017 | 0.0029 | K    |   |
| Heat efficiency, net (%), name plate                                     | 65.1   | 65.3   | 65.2   | 65.2   | 43     | 67     | 43     | 67     | B, H | 1 |
| Heat efficiency, net (%), annual average                                 | 66.8   | 66.9   | 66.8   | 66.8   | 46     | 69     | 46     | 69     | B, H | 1 |
| Additional heat potential with heat pumps (% of thermal input)           | 1.7    | 1.7    | 1.7    | 1.7    | 1      | 13     | 1      | 13     | C    | 1 |

**Notes:**

- A The boiler in the plant is a suspension fired boiler producing steam to be used in a subsequent steam turbine. Currently, the steam turbine is expected to be a back-pressure turbine with no re-heat. In some of the future scenarios it is assumed that the prices on electricity will allow for an increased electrical efficiency and subsequently re-heating of steam is introduced.  
The system is optimised at DH return temperature 40°C and flow 80°C.
- B Through a turbine by-pass all the produced steam energy can be used for District Heat production.
- C Since wood pellets are relatively dry there is often only a minor efficiency advantage in using flue gas condensation. There is though an environmental advantage in having a scrubber in the flue gas stream. Direct condensation and combustion air humidification are included in all cases except in lower/upper ranges of 2020 and 2050.
- D This is given by grid code (Energinet.dk)
- E A limiting factor for the hot and cold start-up times is the size of the hot water tank (deaerator).
- F This plant is equipped with an SCR catalyst for DeNOx and an electrostatic precipitator for catching dust/fly ash
- G Warm start is starting with the steam system being pressurized.
- H The total efficiency is the sum of electricity efficiency and heat efficiency, applicable for "name plate" and "annual average", respectively. The "annual average" electricity efficiency is lower than "name plate" due to turbine outages and other incidents. The resulting lost power production is recovered as heat. This is why "annual average" heat efficiency is higher than "name plate" heat. Efficiencies refer to lower heating value. The parasitic electricity consumption has been subtracted in the listed electricity efficiencies.
- I The Cv value does not exist for plants with a back pressure turbine or an ORC turbine
- J Investment applies to a standard plant. There could be cost related to the actual project or site that adds to the total investment, e.g. additional fuel storage, facilities for chipping of logs, conditions for foundation and harbour facilities.  
Financial data and Technological specific data are essentially the total cost either divided by the electric net capacity, i.e. corresponding to the indicated name plate efficiencies, or by the thermal input. This is to indicate that new plants may not fully take advantage of the technical capabilities for full electricity production capacity. The two cost for electricity and thermal input, respectively, are not to be added up!
- K Note that investments include only two days fuel storage, and more may be optimal, depending on fuel supply opportunities and heat supply obligations, amongst other things.  
The additional investment is listed in the bottom row.
- L Variable O&M cost includes consumables (for FGT etc.), disposal of residues and maintenance cost. Cost for disposal of recovered flue gas condensate is included at a rate of 1.0 €/tonne of condensate. Electricity consumption is not included for CHP, and revenues from sale of electricity and heat are not included. Taxes are not included.

**References**

- Rambøll Danmark, internal evaluation based on either existing projects, supplier offers, or pre-project studies.
- EU-commission, LCP BREF note. Thierry Lecomte, José Félix Ferrería de la Fuente, Frederik Neuwahl, Michele Canova, Antoine Pinasseau, Ivan Jankov, Thomas Brinkmann, Serge Roudier, Luis Delgado Sancho; Best Available Techniques (BAT) Reference Document for Large Combustion Plants; EUR 28836 EN; doi:10.2760/949



## Data sheets Wood Pellets CHP, large, 50/100 °C return/forward temperature

| Technology   | Large Wood Pellets CHP, 800 MW feed |        |        |        |                    |        |                    |        |      |     |
|--|-------------------------------------|--------|--------|--------|--------------------|--------|--------------------|--------|------|-----|
|  | 2015                                | 2020   | 2030   | 2050   | Uncertainty (2020) |        | Uncertainty (2050) |        | Note | Ref |
| <b>Energy/technical data</b>                                 |                                     |        |        |        | Lower              | Upper  | Lower              | Upper  |      |     |
| Generating capacity for one unit (MWe)                       | 252.9                               | 253.4  | 254.1  | 254.1  | 248.1              | 333.4  | 248.1              | 333.8  | A    |     |
| Electricity efficiency, net (%), name plate                  | 31.6                                | 31.7   | 31.8   | 31.8   | 31                 | 42     | 31                 | 42     | A, H | 1   |
| Electricity efficiency, net (%), annual average              | 30.0                                | 30.1   | 30.2   | 30.2   | 27                 | 40     | 27                 | 40     | A, H | 1   |
| Auxiliary electricity consumption (% of thermal input)       | 3.3                                 | 3.3    | 3.3    | 3.3    | 2.4                | 3.7    | 1.9                | 3.7    |      | 1   |
| Cb coefficient (50°C/100°C)                                  | 0.49                                | 0.49   | 0.49   | 0.49   | 0.48               | 0.64   | 0.48               | 0.65   |      |     |
| Cv coefficient (50°C/100°C)                                  | 1                                   | 1      | 1      | 1      | 1                  | 1      | 1                  | 1      | I    |     |
| Forced outage (%)  | 3                                   | 3      | 3      | 3      | 3                  | 3      | 3                  | 3      |      |     |
| Planned outage (weeks per year)                              | 3.0                                 | 3.0    | 3.0    | 3.0    | 2.6                | 3.5    | 2.3                | 3.8    |      |     |
| Technical lifetime (years)                                   | 25                                  | 25     | 25     | 25     | 20                 | 35     | 20                 | 35     |      | 1   |
| Construction time (years)                                    | 5                                   | 5      | 5      | 5      | 4.5                | 5.5    | 4                  | 5.5    |      | 1   |
| Space requirement (1000 m2/MWe)                              | 0.06                                | 0.06   | 0.06   | 0.06   | 0.05               | 0.07   | 0.04               | 0.07   |      |     |
| <b>Regulation ability</b>                                    |                                     |        |        |        |                    |        |                    |        |      |     |
| Primary regulation (% per 30 seconds)                        | 2                                   | 2      | 2      | 2      | 2                  | 2      | 2                  | 2      |      |     |
| Secondary regulation (% per minute)                          | 4                                   | 4      | 4      | 4      | 4                  | 4      | 4                  | 4      | D    | 1   |
| Minimum load (% of full load)                                | 15                                  | 15     | 15     | 15     | 15                 | 15     | 15                 | 15     |      | 1   |
| Warm start-up time (hours)                                   | 2                                   | 2      | 2      | 2      | 2                  | 2      | 2                  | 2      | G    | 1   |
| Cold start-up time (hours)                                   | 12                                  | 12     | 12     | 12     | 12                 | 12     | 12                 | 12     | E    | 1   |
| <b>Environment</b>   |                                     |        |        |        |                    |        |                    |        |      |     |
| SO <sub>2</sub> (degree of desulphuring, %)                  | 98.3                                | 98.3   | 98.3   | 98.3   | 95.6               | 99.1   | 98.3               | 99.1   |      | 1,2 |
| NO <sub>x</sub> (g per GJ fuel)                              | 20                                  | 20     | 20     | 10     | 10                 | 30     | 10                 | 20     | C+F  | 1,2 |
| CH <sub>4</sub> (g per GJ fuel)                              | 0                                   | 0      | 0      | 0      | 0                  | 0      | 0                  | 0      |      | 1,2 |
| N <sub>2</sub> O (g per GJ fuel)                             | 1                                   | 1      | 1      | 1      | 1                  | 3      | 0                  | 1      |      | 1,2 |
| Particles (g per GJ fuel)                                    | 0.3                                 | 0.3    | 0.3    | 0.3    | 0.1                | 2.0    | 0.1                | 1.0    |      | 1,2 |
| <b>Financial data</b>  |                                     |        |        |        |                    |        |                    |        |      |     |
| Nominal investment (M€/MWe)                                  | 2.44                                | 2.38   | 2.26   | 2.05   | 2.02               | 2.79   | 1.66               | 2.81   | J,K  | 1   |
| - of which equipment   | 1.36                                | 1.33   | 1.26   | 1.15   | 1.10               | 1.56   | 0.91               | 1.56   | K    |     |
| - of which installation                                      | 1.08                                | 1.05   | 1.00   | 0.90   | 0.92               | 1.24   | 0.75               | 1.24   | K    |     |
| Fixed O&M (€/MWe/year)                                       | 68,000                              | 66,000 | 63,000 | 58,000 | 56,000             | 77,000 | 45,000             | 75,000 |      |     |
| Variable O&M (€/MWh <sub>e</sub> )                           | 1.7                                 | 1.7    | 1.7    | 1.7    | 1.5                | 2.0    | 1.3                | 2.1    | L    |     |
| <b>Technology specific data</b>                              |                                     |        |        |        |                    |        |                    |        |      |     |
| Steam reheat   | None                                | None   | None   | None   | None               | Yes    | None               | Yes    |      |     |
| Flue gas condensation  | Yes                                 | Yes    | Yes    | Yes    | No                 | Yes    | No                 | Yes    | C    |     |
| Combustion air humidification                                | Yes                                 | Yes    | Yes    | Yes    | No                 | Yes    | No                 | Yes    | C    |     |
| Output of recovered condensate (tonne/MWh <sub>input</sub> ) | 0.03                                | 0.03   | 0.03   | 0.03   | 0.00               | 0.03   | 0.00               | 0.03   | C,L  |     |
| Nominal investment (M€/MW fuel input)                        | 0.77                                | 0.75   | 0.72   | 0.65   | 0.64               | 0.89   | 0.53               | 0.89   | J,K  | 1   |
| - of which equipment   | 0.43                                | 0.42   | 0.40   | 0.36   | 0.35               | 0.49   | 0.29               | 0.50   | K    |     |

|  |        |        |        |        |        |        |        |        |      |   |
|--|--------|--------|--------|--------|--------|--------|--------|--------|------|---|
| - of which installation  | 0.34   | 0.33   | 0.32   | 0.29   | 0.29   | 0.39   | 0.24   | 0.40   | K    |   |
| Fixed O&M (€/MW input/year)  | 21,400 | 20,900 | 20,000 | 18,300 | 17,600 | 24,300 | 14,100 | 23,900 |      |   |
| Variable O&M (€/MWh input) *   | 0.54   | 0.55   | 0.55   | 0.55   | 0.46   | 0.63   | 0.41   | 0.68   | L    |   |
| Fuel storage specific cost in excess of 2 days (M€/MW_input/storage day) | 0.0025 | 0.0024 | 0.0023 | 0.0021 | 0.0021 | 0.0029 | 0.0017 | 0.0029 | K    |   |
| Heat efficiency, net (%), name plate                                     | 64.6   | 64.8   | 64.7   | 64.7   | 43     | 67     | 43     | 67     | B, H | 1 |
| Heat efficiency, net (%), annual average                                 | 66.1   | 66.4   | 66.3   | 66.3   | 47     | 69     | 47     | 69     | B, H | 1 |
| Additional heat potential with heat pumps (% of thermal input)           | 4.1    | 4.0    | 4.0    | 4.0    | 3      | 13     | 3      | 13     | C    | 1 |

**Notes:**

- A The boiler in the plant is a suspension fired boiler producing steam to be used in a subsequent steam turbine. Currently, the steam turbine is expected to be a backpressure turbine with no re-heat. In some of the future scenarios it is assumed that the prices on electricity will allow for an increased electrical efficiency and subsequently re-heating of steam is introduced.
- The system is optimised at DH return temperature 50°C and flow 100°C. With DH return temperature 40 °C and flow 50 °C, the name plate net electricity efficiency (2015) is
- B Through a turbine by-pass all the produced steam energy can be used for District Heat production.
- C Since wood pellets are relatively dry there is often only a minor efficiency advantage in using flue gas condensation. There is though an environmental advantage in having a scrubber in the flue gas stream. Direct condensation and combustion air humidification are included in all cases except in lower/upper ranges of 2020 and 2050.
- D This is given by grid code (Energinet.dk)
- E A limiting factor for the hot and cold start-up times is the size of the hot water tank (deaerator).
- F This plant is equipped with an SCR catalyst for DeNOx and an electrostatic precipitator for catching dust/fly ash
- G Warm start is starting with the steam system being pressurized.
- H The total efficiency is the sum of electricity efficiency and heat efficiency, applicable for "name plate" and "annual average", respectively. The "annual average" electricity efficiency is lower than "name plate" due to turbine outages and other incidents. The resulting lost power production is recovered as heat. This is why "annual average" heat efficiency is higher than "name plate" heat. Efficiencies refer to lower heating value. The parasitic electricity consumption has been subtracted in the listed electricity efficiencies.
- I The Cv value does not exist for plants with a backpressure turbine or an ORC turbine
- J Investment applies to a standard plant. There could be cost related to the actual project or site that adds to the total investment, e.g. additional fuel storage, facilities for chipping of logs, conditions for foundation and harbour facilities.  
Financial data and Technological specific data are essentially the total cost either divided by the electric net capacity, i.e. corresponding to the indicated name plate efficiencies, or by the thermal input. This is to indicate that new plants may not fully take advantage of the technical capabilities for full electricity production capacity. The two cost for electricity and thermal input, respectively, are not to be added up!
- K Note that investments include only two days fuel storage, and more may be optimal, depending on fuel supply opportunities and heat supply obligations, amongst other things.  
The additional investment is listed in the bottom row.
- L Variable O&M cost includes consumables (for FGT etc.), disposal of residues and maintenance cost. Cost for disposal of recovered flue gas condensate is included at a rate of 1.0 €/tonne of condensate. Electricity consumption is not included for CHP, and revenues from sale of electricity and heat are not included. Taxes are not included.

**References**

- 1 Rambøll Danmark, internal evaluation based on either existing projects, supplier offers, or pre-project studies.
- 2 EU-commission, LCP BREF note. Thierry Lecomte, José Félix Ferrería de la Fuente, Frederik Neuwahl, Michele Canova, Antoine Pinasseau, Ivan Jankov, Thomas Brinkmann, Serge Roudier, Luis Delgado Sancho; Best Available Techniques (BAT) Reference Document for Large Combustion Plants; EUR 28836 EN; doi:10.2760/949

## Data sheets Wood Pellets CHP, large, extraction

| Technology                                      | Large Wood Pellets CHP, 800 MW feed, Extraction |        |        |                       |                       |        |                       |        |      |     |
|---|---|--------|--------|-----------------------|-----------------------|--------|-----------------------|--------|------|-----|
|   | 2015  | 2020   | 2030   | 2050<br>(with<br>FGC) | Uncertainty<br>(2020) |        | Uncertainty<br>(2050) |        | Note | Ref |
| Energy/technical data                           |   |        |        |                       | Lower                 | Upper  | Lower                 | Upper  |      |     |
| Generating capacity for one unit (MWe)          | 356.4   | 357.6  | 358.7  | 358.4                 | 347.3                 | 359.4  | 351.7                 | 364.4  | A    |     |
| Electricity efficiency, net (%), name plate     | 44.5  | 44.7   | 44.8   | 44.8                  | 43.4                  | 44.9   | 44                    | 45.5   | A, H | 1   |
| Electricity efficiency, net (%), annual average | 42.3  | 42.5   | 42.6   | 42.6                  | 41.2                  | 42.7   | 41.8                  | 43.3   | A, H | 1   |
| Cb coefficient (50°C/100°C)                     | 0.59  | 0.59   | 0.59   | 0.52                  | 0.57                  | 0.52   | 0.59                  | 0.53   |      |     |
| Cv coefficient (50°C/100°C)                     | 0.17  | 0.17   | 0.17   | 0.15                  | 0.17                  | 0.15   | 0.17                  | 0.15   | I    |     |
| Forced outage (%)                               | 3   | 3      | 3      | 3                     | 3                     | 3      | 3                     | 3      |      |     |
| Planned outage (weeks per year)                 | 3   | 3      | 3      | 3                     | 2.6                   | 3.5    | 2.3                   | 3.8    |      |     |
| Technical lifetime (years)                      | 25  | 25     | 25     | 25                    | 25                    | 25     | 25                    | 25     |      | 1   |
| Construction time (years)                       | 5   | 5      | 5      | 5                     | 5                     | 1      | 1                     | 1      |      | 1   |
| Space requirement (1000 m2/MWe)                 | 0.04  | 0.04   | 0.04   | 0.04                  | 0.04                  | 0.04   | 0.04                  | 0.04   |      |     |
| <b>Regulation ability</b>                       |   |        |        |                       |                       |        |                       |        |      |     |
| Primary regulation (% per 30 seconds)           | 2   | 2      | 2      | 2                     | 2                     | 2      | 2                     | 2      |      |     |
| Secondary regulation (% per minute)             | 4   | 4      | 4      | 4                     | 4                     | 4      | 4                     | 4      | D    | 1   |
| Minimum load (% of full load)                   | 15  | 15     | 15     | 15                    | 15                    | 15     | 15                    | 15     |      | 1   |
| Warm start-up time (hours)                      | 2   | 2      | 2      | 2                     | 2                     | 2      | 2                     | 2      | G    | 1   |
| Cold start-up time (hours)                      | 12  | 12     | 12     | 12                    | 12                    | 12     | 12                    | 12     | E    | 1   |
| <b>Environment</b>                              |   |        |        |                       |                       |        |                       |        |      |     |
| SO2 (degree of desulphuring, %)                 | 97.5  | 97.5   | 97.5   | 97.5                  | 97.5                  | 97.5   | 97.5                  | 97.5   |      | 1,2 |
| NOX (g per GJ fuel)                             | 20  | 20     | 20     | 10                    | 10                    | 30     | 10                    | 20     | C+F  | 1,2 |
| CH4 (g per GJ fuel)                             | 0   | 0      | 0      | 0                     | 0                     | 0      | 0                     | 0      |      | 1,2 |
| N2O (g per GJ fuel)                             | 1   | 1      | 1      | 0                     | 0                     | 1      | 0                     | 1      |      | 1,2 |
| Particles (g per GJ fuel)                       | 0.3   | 0.3    | 0.3    | 0.3                   | 0.1                   | 2      | 0.1                   | 1      |      | 1,2 |
| <b>Financial data</b>                           |   |        |        |                       |                       |        |                       |        |      |     |
| Nominal investment (M€/MWe)                     | 2.22  | 2.15   | 2.04   | 1.9                   | 1.93                  | 2.59   | 1.8                   | 2.78   | J,K  | 1   |
| - of which equipment                            | 1.34  | 1.3    | 1.23   | 1.16                  | 1.16                  | 1.58   | 1.08                  | 1.7    | K    |     |
| - of which installation                         | 0.88  | 0.86   | 0.81   | 0.74                  | 0.77                  | 1      | 0.71                  | 1.08   | K    |     |
| Fixed O&M (€/MWe/year)                          | 57 000  | 55 000 | 52 000 | 49 000                | 51 000                | 63 000 | 46 000                | 63 000 |      |     |
| Variable O&M (€/MWeh)                           | 1.1   | 1.1    | 1.1    | 1.1                   | 1.2                   | 1.1    | 1.2                   | 1.1    | L    |     |
| <b>Technology specific data</b>                 |   |        |        |                       |                       |        |                       |        |      |     |
| Steam reheat                                    | Yes   | Yes    | Yes    | Yes                   | Yes                   | Yes    | Yes                   | Yes    |      |     |
| Flue gas condensation                           | No  | no     | no     | Yes                   | no                    | Yes    | no                    | Yes    | C    |     |
| Combustion air humidification                   | No  | no     | no     | Yes                   | no                    | Yes    | no                    | Yes    |      |     |

|  |        |        |        |        |        |        |        |        |     |   |
|--|--------|--------|--------|--------|--------|--------|--------|--------|-----|---|
| Additional heat potential with heat pumps (% of thermal input)     | -      | -      | -      | 3.6    | -      | 3.6    | -      | 3.6    | C   | 1 |
| Nominal investment (M€/MWth) (fuel input)                          | 0.99   | 0.96   | 0.92   | 0.85   | 0.84   | 1.16   | 0.79   | 1.26   | J,K | 1 |
| - of which equipment   | 0.59   | 0.58   | 0.55   | 0.52   | 0.51   | 0.71   | 0.48   | 0.77   | K   |   |
| - of which installation  | 0.39   | 0.38   | 0.36   | 0.33   | 0.33   | 0.45   | 0.31   | 0.49   | K   |   |
| Fixed O&M (€/MW input/year)  | 25 200 | 24 600 | 23 500 | 21 900 | 22 200 | 28 300 | 20 000 | 28 600 |     |   |
| Variable O&M (€/MWh input)   | 0.51   | 0.51   | 0.51   | 0.51   | 0.51   | 0.51   | 0.51   | 0.51   | L   |   |
| Fuel storage specific cost in excess of 2 days (M€/MW/storage day) | 0.0025 | 0.0025 | 0.0025 | 0.0025 | 0.0025 | 0.0025 | 0.0025 | 0.0025 | K   |   |

## References

- 1 Rambøll Danmark, internal evaluation based on either existing projects, supplier offers, or pre-project studies.
- 2 EU-commission, LCP BREF note. Thierry Lecomte, José Félix Ferrería de la Fuente, Frederik Neuwahl, Michele Canova, Antoine Pinasseau, Ivan Jankov, Thomas Brinkmann, Serge Roudier, Luis Delgado Sancho; Best Available Techniques (BAT) Reference Document for Large Combustion Plants; EUR 28836 EN; doi:10.2760/949

## Notes:

- A The boiler in the plant is a suspension fired boiler producing steam to be used in a subsequent extraction steam turbine with steam reheat.
- B
- C Additional heat potential for heat pump is the flue gas condensation potential remaining after the direct condensation stage (condensation by heat exchange with DH-water). This comes in addition to direct condensation that may yield additional 6% (of thermal input) when operated with combustion air humidification and assuming 50 °C DH return temperature. DH water may be heated in two (or more) stages, first stage being direct condensation (at hardly any drop in electricity output), second stage extraction steam with drop in electricity output, cf. the listed Cv-value. For the 2050 estimate flue gas condensation has been included to super-optimize and show the order of advantage is a reduction of the Cv of 0.02 as resulting average for maximum heat output including condensation.
- D This is given by grid code (Energinet.dk)
- E A limiting factor for the hot and cold start-up times is the size of the hot water tank (deaerator).
- F This plant is equipped with a Tail-end SCR catalyst for DeNOx and an electrostatic precipitator for catching dust/fly ash
- G Warm start is starting with the steam system being pressurized.
- H The electricity efficiency is applicable for "name plate" and "annual average", respectively. The "annual average" electricity efficiency is lower than "name plate" due to the effects of load variations, turbine outages and other incidents. Efficiencies refer to thermal input by lower heating value. The parasitic electricity consumption has been subtracted in the listed electricity efficiencies.
- I The Cv value may vary according to the optimisation of the plant. A modest value representing a choice with current power/heat prices is shown.
- J Investment applies to a standard plant. There could be cost related to the actual project or site that adds to the total investment, e.g. additional fuel storage, conditions for foundation and harbour facilities. Financial data and Technological specific data are essentially the total cost either divided by the electric net capacity, i.e. corresponding to the indicated name plate efficiencies, or by the thermal input. This is to indicate that new plants may not fully take advantage of the technical capabilities for full electricity production capacity. The two cost for electricity and

thermal input, respectively, are not to be added up!

- K Note that investments include only two days fuel storage, and more may be optimal, depending on fuel supply opportunities energy supply obligations, amongst other things. The additional investment is listed in the bottom row.
- L Variable O&M cost includes consumables (for FGT etc.), disposal of residues and maintenance cost. Cost for disposal of recovered flue gas condensate, if applicable, is not included. Electricity consumption is not included as a cost for CHP, and revenues from sale of electricity and heat are not included. Taxes are not included.

## Data sheets Straw CHP, small

| Technology   | Small Straw CHP, 20 MW feed |         |         |         |                    |              |                    |              |       |     |
|--|-----------------------------|---------|---------|---------|--------------------|--------------|--------------------|--------------|-------|-----|
|  | 2015                        | 2020    | 2030    | 2050    | Uncertainty (2020) |              | Uncertainty (2050) |              | Note  | Ref |
| <b>Energy/technical data</b>                                 |                             |         |         |         | <b>Lower</b>       | <b>Upper</b> | <b>Lower</b>       | <b>Upper</b> |       |     |
| Generating capacity for one unit (MWe)                       | 3.0                         | 3.0     | 3.1     | 3.0     | 3.0                | 3.1          | 2.9                | 3.0          | A     |     |
| Electricity efficiency, net (%), name plate                  | 15.2                        | 15.2    | 15.3    | 15.1    | 14                 | 16           | 14                 | 16           | A, H  | 1   |
| Electricity efficiency, net (%), annual average              | 14.5                        | 14.5    | 14.5    | 14.3    | 13                 | 15           | 13                 | 15           | A, H  | 1   |
| Auxiliary electricity consumption (% of thermal input)       | 2.4                         | 2.4     | 2.4     | 2.4     | 1.8                | 2.6          | 1.4                | 2.6          |       | 1.0 |
| Cb coefficient (40°C/80°C)                                   | 0.18                        | 0.18    | 0.18    | 0.18    | 0.17               | 0.18         | 0.17               | 0.18         |       |     |
| Cv coefficient (40°C/80°C)                                   | 1                           | 1       | 1       | 1       | 1                  | 1            | 1                  | 1            | I     |     |
| Forced outage (%)  | 4                           | 4       | 4       | 4       | 4                  | 4            | 4                  | 4            |       |     |
| Planned outage (weeks per year)                              | 4.0                         | 4.0     | 4.0     | 4.0     | 3.4                | 4.6          | 3.0                | 5.0          |       |     |
| Technical lifetime (years)                                   | 25                          | 25      | 25      | 25      | 20                 | 35           | 20                 | 35           |       | 1   |
| Construction time (years)                                    | 1                           | 1       | 1       | 1       | 0.5                | 1.5          | 0.5                | 1.5          |       | 1   |
| Space requirement (1000 m2/MWe)                              | 1.0                         | 1.0     | 1.0     | 1.0     | 0.8                | 1.1          | 0.7                | 1.2          |       |     |
| <b>Regulation ability</b>                                    |                             |         |         |         |                    |              |                    |              |       |     |
| Primary regulation (% per 30 seconds)                        | NA                          | NA      | NA      | NA      | NA                 | NA           | NA                 | NA           |       |     |
| Secondary regulation (% per minute)                          | 10                          | 10      | 10      | 10      | 10                 | 10           | 10                 | 10           | D     | 1   |
| Minimum load (% of full load)                                | 50                          | 50      | 50      | 50      | 50                 | 50           | 50                 | 50           | D     | 1   |
| Warm start-up time (hours)                                   | 0.25                        | 0.25    | 0.25    | 0.25    | 0.25               | 0.25         | 0.25               | 0.25         | G     | 1   |
| Cold start-up time (hours)                                   | 0.5                         | 0.5     | 0.5     | 0.5     | 0.5                | 0.5          | 0.5                | 0.5          |       | 1   |
| <b>Environment</b>   |                             |         |         |         |                    |              |                    |              |       |     |
| SO <sub>2</sub> (degree of desulphuring, %)                  | 95.5                        | 96.4    | 99.1    | 99.8    | 90.9               | 99.8         | 95.5               | 99.9         | F     | 1   |
| NO <sub>x</sub> (g per GJ fuel)                              | 90                          | 70      | 50      | 40      | 50                 | 90           | 40                 | 50           | F     | 1   |
| CH <sub>4</sub> (g per GJ fuel)                              | 16                          | 11      | 8       | 4       | 4                  | 16           | 2                  | 16           | F     | 1   |
| N <sub>2</sub> O (g per GJ fuel)                             | 1                           | 1       | 1       | 1       | 1                  | 3            | 0                  | 1            | F     | 1   |
| Particles (g per GJ fuel)                                    | 2.0                         | 0.3     | 0.3     | 0.3     | 0.1                | 2.0          | 0.1                | 1.0          | F     | 1   |
| <b>Financial data</b>  |                             |         |         |         |                    |              |                    |              |       |     |
| Nominal investment (M€/MWe)                                  | 6.9                         | 6.7     | 6.3     | 6.1     | 5.8                | 7.9          | 5.1                | 8.3          | E,J,K | 1   |
| - of which equipment   | 3.9                         | 3.8     | 3.6     | 3.6     | 3.3                | 4.4          | 3.0                | 4.8          | K     |     |
| - of which installation                                      | 3.0                         | 2.9     | 2.8     | 2.5     | 2.5                | 3.4          | 2.1                | 3.5          | K     |     |
| Fixed O&M (€/MWe/year)                                       | 318,000                     | 313,000 | 302,000 | 293,000 | 268,000            | 362,000      | 227,000            | 375,000      | J     |     |
| Variable O&M (€/MWh <sub>e</sub> )                           | 4.5                         | 4.5     | 4.5     | 4.6     | 3.3                | 5.1          | 3.0                | 5.6          | L     |     |
| <b>Technology specific data</b>                              |                             |         |         |         |                    |              |                    |              |       |     |
| Steam reheat   | None                        | None    | None    | None    | None               | None         | None               | None         |       |     |
| Flue gas condensation  | Yes                         | Yes     | Yes     | Yes     | No                 | Yes          | No                 | Yes          | C     |     |
| Combustion air humidification                                | Yes                         | Yes     | Yes     | Yes     | No                 | Yes          | No                 | Yes          | C     |     |
| Output of recovered condensate (tonne/MWh <sub>input</sub> ) | 0.09                        | 0.09    | 0.09    | 0.09    | 0.00               | 0.09         | 0.00               | 0.09         | C, L  |     |
| Nominal investment (M€/MW fuel input)                        | 1.05                        | 1.02    | 0.97    | 0.92    | 0.89               | 1.20         | 0.77               | 1.25         | E,J,K | 1   |

|  |        |        |        |        |        |        |        |        |      |   |
|--|--------|--------|--------|--------|--------|--------|--------|--------|------|---|
| Variable O&M, including electricity (€/MWh input)                        | 0.59   | 0.58   | 0.55   | 0.53   | 0.50   | 0.68   | 0.45   | 0.72   | K    |   |
| - of which installation  | 0.46   | 0.44   | 0.42   | 0.38   | 0.39   | 0.52   | 0.32   | 0.53   | K    |   |
| Fixed O&M (€/MW input/year)  | 48,600 | 47,700 | 46,100 | 44,100 | 40,800 | 55,300 | 34,200 | 56,500 | J    |   |
| Variable O&M (€/MWh input) *   | 0.69   | 0.69   | 0.69   | 0.69   | 0.51   | 0.78   | 0.45   | 0.84   | L    |   |
| Fuel storage specific cost in excess of 2 days (M€/MW_input/storage day) | 0.080  | 0.078  | 0.074  | 0.067  | 0.068  | 0.092  | 0.056  | 0.093  | K    |   |
| Heat efficiency, net (%), name plate                                     | 85.6   | 85.6   | 85.5   | 85.8   | 72     | 87     | 71     | 87     | B, H | 1 |
| Heat efficiency, net (%), annual average                                 | 86.3   | 86.3   | 86.3   | 86.5   | 73     | 88     | 72     | 88     | B, H | 1 |
| Additional heat potential with heat pumps (% of thermal input)           | 1.8    | 1.8    | 1.8    | 1.8    | 1      | 14     | 1      | 15     | C    | 1 |

**Notes:**

- A The plant is directly producing hot water for District Heating by burning fuel on a grate. The electric power is produced by an ORC module (Organic Rankine Cycle; Waste Heat Recovery - WHR). Refer for instance to the following link for further information about technology and suppliers: [http://www.enova.no/upload\\_images/36AC689098414B05A7112FA2EE985BDA.pdf](http://www.enova.no/upload_images/36AC689098414B05A7112FA2EE985BDA.pdf) This is low temperature and low efficiency electric power but at an affordable price.  
The system is optimised at DH return temperature 40°C and flow 80°C.
- B Boilers up to 20 MW fuel input for hot water production are more or less standardized products with a high degree of fuel flexibility (type of biomass, humidity etc.)
- C Since straw is relatively dry there is often only a minor efficiency advantage in using flue gas condensation. There is though an environmental advantage in having a scrubber in the flue gas stream. Direct condensation and combustion air humidification are included in all cases except in lower/upper range of 2020 and 2050.
- D Secondary regulation normally relates to power production; for this type of plant it may not be of importance. Though, the load control of the heat production is important and most units will perform better than the figure shown. Also, minimum load could be substantially lower.
- E Since electricity generation is only a secondary objective for minor heat producers, it may make more sense to relate the total investment only to the heat production capacity.
- F Emissions shall comply with the order of the Danish EPA no 1535 of 2019 (Bekendtgørelse om miljøkrav for mellemstore fyringsanlæg), implementing the Medium Combustion Directive, Directive (EU) 2015/2193 of the European Parliament and of the Council of 25 November 2015 on the limitation of emissions of certain pollutants into the air from medium combustion plants..  
It is anticipated that for the smaller units the supplier has an SNCR solution to reduce NOx emissions sufficiently. However, to reach NOx-levels below 40 g/GJ SCR is assumed.
- G Warm start is starting with a glowing fuel layer on the grate.
- H The total efficiency is the sum of electricity efficiency and heat efficiency, applicable for "name plate" and "annual average", respectively. The "annual average" electricity efficiency is lower than "name plate" due to turbine outages and other incidents. The resulting lost power production is recovered as heat. This is why "annual average" heat efficiency is higher than "name plate" heat. Efficiencies refer to lower heating value. The parasitic electricity consumption has been subtracted in the listed electricity efficiencies.
- I The Cv value does not exist for plants with a backpressure turbine or an ORC turbine
- J Investment applies to a standard plant. There could be cost related to the actual project or site that adds to the total investment, e.g. additional fuel storage, facilities for chipping of logs, conditions for foundation and harbour facilities.  
Financial data and Technological specific data are essentially the total cost either divided by the electric net capacity, i.e. corresponding to the indicated name plate efficiencies, or by the thermal input. This is to indicate that new plants may not fully take advantage of the technical capabilities for full electricity production capacity. The two cost for electricity and thermal input, respectively, are not to be added up!
- K Note that investments include only two days fuel storage, and more may be optimal, depending on fuel supply opportunities and heat supply obligations, amongst other things.  
The additional investment is listed in the bottom row.
- L Variable O&M cost includes consumables (for FGT etc.), disposal of residues and maintenance cost. Cost for disposal of recovered flue gas condensate is included at a rate of 1.0 €/tonne of condensate. Electricity consumption is not included for CHP, and revenues from sale of electricity and heat are not included. Taxes are not included.

## References

- 1 Rambøll Danmark, internal evaluation based on either existing projects, supplier offers, or pre-project studies.



## Data sheets Straw CHP, medium

| Technology   | Medium Straw CHP, 80 MW feed |         |         |         |                    |         |                    |         |      |     |
|--|------------------------------|---------|---------|---------|--------------------|---------|--------------------|---------|------|-----|
|  | 2015                         | 2020    | 2030    | 2050    | Uncertainty (2020) |         | Uncertainty (2050) |         | Note | Ref |
| <b>Energy/technical data</b>                                 |                              |         |         |         | Lower              | Upper   | Lower              | Upper   |      |     |
| Generating capacity for one unit (MWe)                       | 25.3                         | 25.3    | 25.4    | 25.0    | 23.7               | 25.7    | 24.3               | 25.8    | A    |     |
| Electricity efficiency, net (%), name plate                  | 31.6                         | 31.6    | 31.7    | 31.2    | 29                 | 33      | 30                 | 33      | A, H | 1   |
| Electricity efficiency, net (%), annual average              | 30.0                         | 30.0    | 30.1    | 29.7    | 26                 | 31      | 27                 | 31      | A, H | 1   |
| Auxiliary electricity consumption (% of thermal input)       | 2.8                          | 2.8     | 2.8     | 2.8     | 2.1                | 3.2     | 1.7                | 3.2     |      | 1   |
| Cb coefficient (40°C/80°C)                                   | 0.46                         | 0.46    | 0.46    | 0.45    | 0.43               | 0.47    | 0.44               | 0.47    |      |     |
| Cv coefficient (40°C/80°C)                                   | 1                            | 1       | 1       | 1       | 1                  | 1       | 1                  | 1       | I    |     |
| Forced outage (%)  | 4                            | 4       | 4       | 4       | 4                  | 4       | 4                  | 4       |      |     |
| Planned outage (weeks per year)                              | 4.0                          | 4.0     | 4.0     | 4.0     | 3.4                | 4.6     | 3.0                | 5.0     |      |     |
| Technical lifetime (years)                                   | 25                           | 25      | 25      | 25      | 20                 | 35      | 20                 | 35      |      | 1   |
| Construction time (years)                                    | 2.5                          | 2.5     | 2.5     | 2.5     | 2                  | 3       | 1.5                | 3       |      | 1   |
| Space requirement (1000 m2/MWe)                              | 0.3                          | 0.3     | 0.3     | 0.3     | 0.2                | 0.3     | 0.2                | 0.4     |      |     |
| <b>Regulation ability</b>                                    |                              |         |         |         |                    |         |                    |         |      |     |
| Primary regulation (% per 30 seconds)                        | NA                           | NA      | NA      | NA      | NA                 | NA      | NA                 | NA      |      |     |
| Secondary regulation (% per minute)                          | 4                            | 4       | 4       | 4       | 4                  | 4       | 4                  | 4       | D    | 1   |
| Minimum load (% of full load)                                | 40                           | 40      | 40      | 40      | 40                 | 40      | 40                 | 40      |      |     |
| Warm start-up time (hours)                                   | 2                            | 2       | 2       | 2       | 2                  | 2       | 2                  | 2       | E    | 1   |
| Cold start-up time (hours)                                   | 8                            | 8       | 8       | 8       | 8                  | 8       | 8                  | 8       |      | 1   |
| <b>Environment</b>   |                              |         |         |         |                    |         |                    |         |      |     |
| SO <sub>2</sub> (degree of desulphuring, %)                  | 95.5                         | 96.4    | 99.1    | 99.8    | 90.9               | 99.8    | 95.5               | 99.9    | F    | 1,2 |
| NO <sub>x</sub> (g per GJ fuel)                              | 90                           | 70      | 50      | 30      | 20                 | 90      | 10                 | 50      | F    | 1,2 |
| CH <sub>4</sub> (g per GJ fuel)                              | 0                            | 0       | 0       | 0       | 0                  | 0       | 0                  | 0       | F    | 1,2 |
| N <sub>2</sub> O (g per GJ fuel)                             | 1                            | 1       | 1       | 1       | 1                  | 3       | 0                  | 1       | F    | 1,2 |
| Particles (g per GJ fuel)                                    | 2.0                          | 0.3     | 0.3     | 0.3     | 0.1                | 2.0     | 0.1                | 1.0     | F    | 1,2 |
| <b>Financial data</b>  |                              |         |         |         |                    |         |                    |         |      |     |
| Nominal investment (M€/MWe)                                  | 3.7                          | 3.6     | 3.4     | 3.2     | 3.0                | 4.3     | 2.6                | 4.4     | J,K  | 1   |
| - of which equipment   | 2.2                          | 2.2     | 2.0     | 2.0     | 1.8                | 2.6     | 1.6                | 2.7     | J,K  | 1   |
| - of which installation                                      | 1.4                          | 1.4     | 1.3     | 1.2     | 1.2                | 1.7     | 1.0                | 1.7     | J,K  | 1   |
| Fixed O&M (€/MWe/year)                                       | 147,000                      | 143,000 | 134,000 | 124,000 | 120,000            | 168,000 | 95,000             | 160,000 | J    | 1   |
| Variable O&M (€/MWh <sub>e</sub> )                           | 2.1                          | 2.1     | 2.1     | 2.1     | 1.6                | 2.4     | 1.4                | 2.6     | L    | 1   |
| <b>Technology specific data</b>                              |                              |         |         |         |                    |         |                    |         |      |     |
| Steam reheat   | None                         | None    | None    | None    | None               | None    | None               | None    |      |     |
| Flue gas condensation  | Yes                          | Yes     | Yes     | Yes     | No                 | Yes     | No                 | Yes     | C    |     |
| Combustion air humidification                                | Yes                          | Yes     | Yes     | Yes     | No                 | Yes     | No                 | Yes     | C    |     |
| Output of recovered condensate (tonne/MWh <sub>input</sub> ) | 0.09                         | 0.09    | 0.09    | 0.09    | 0.00               | 0.09    | 0.00               | 0.09    | C, L |     |
| Nominal investment (M€/MW fuel input)                        | 1.16                         | 1.13    | 1.07    | 1.00    | 0.95               | 1.36    | 0.81               | 1.37    | J,K  | 1   |

|  |        |        |        |        |        |        |        |        |      |   |
|--|--------|--------|--------|--------|--------|--------|--------|--------|------|---|
| Variable O&M, including electricity (€/MWh input)                        | 0.70   | 0.68   | 0.65   | 0.62   | 0.56   | 0.84   | 0.49   | 0.84   | K    |   |
| - of which installation  | 0.46   | 0.45   | 0.42   | 0.38   | 0.39   | 0.53   | 0.32   | 0.53   | K    |   |
| Fixed O&M (€/MW input/year)  | 46,600 | 45,200 | 42,600 | 38,700 | 38,000 | 53,000 | 29,600 | 49,900 | J    |   |
| Variable O&M (€/MWh input) *   | 0.66   | 0.66   | 0.66   | 0.66   | 0.51   | 0.76   | 0.45   | 0.82   | L    |   |
| Fuel storage specific cost in excess of 2 days (M€/MW_input/storage day) | 0.070  | 0.068  | 0.065  | 0.059  | 0.060  | 0.081  | 0.049  | 0.081  | K    |   |
| Heat efficiency, net (%), name plate                                     | 68.6   | 68.6   | 68.5   | 69.0   | 53     | 72     | 53     | 71     | B, H | 1 |
| Heat efficiency, net (%), annual average                                 | 70.2   | 70.2   | 70.1   | 70.6   | 56     | 74     | 56     | 73     | B, H | 1 |
| Additional heat potential with heat pumps (% of thermal input)           | 1.8    | 1.8    | 1.8    | 1.8    | 1      | 15     | 1      | 15     | C    | 1 |

**Notes:**

- A The boiler in the plant is grate fired producing steam to be used in a subsequent backpressure steam turbine. Though a grate is reasonable flexible with respect to combusting different fuels the fuel feed system will be dependent on the type of fuel used.  
The system is optimised at DH return temperature 40°C and flow 80°C.
- B Through a turbine by-pass all the produced steam energy can be used for District Heat production.
- C Since straw is relatively dry there is often only a minor efficiency advantage in using flue gas condensation. There is though an environmental advantage in having a scrubber in the flue gas stream. Direct condensation and combustion air humidification are included in all cases except in lower/upper range of 2020 and 2050.
- D Secondary regulation normally relates to power production; for this type of plant it may not be of importance since load will normally follow heat consumption.
- E A limiting factor for the hot and cold start-up times is the size of the hot water tank (deaerator).
- F For NO<sub>x</sub>-emissions no lower than 40 g/GJ SNCR is assumed. It is probably necessary to include a tail-end SCR catalyst to fulfill expected BREF requirements, particularly after year 2030. This has slight adverse effect on the electricity efficiency.
- G Warm start is starting with a glowing fuel layer on the grate and a warm deaerator.
- H The total efficiency is the sum of electricity efficiency and heat efficiency, applicable for "name plate" and "annual average", respectively. The "annual average" electricity efficiency is lower than "name plate" due to turbine outages and other incidents. The resulting lost power production is recovered as heat. This is why "annual average" heat efficiency is higher than "name plate" heat. Efficiencies refer to lower heating value. The parasitic electricity consumption has been subtracted in the listed electricity efficiencies.
- I The Cv value does not exist for plants with a backpressure turbine or an ORC turbine
- J Investment applies to a standard plant. There could be cost related to the actual project or site that adds to the total investment, e.g. additional fuel storage, facilities for chipping of logs, conditions for foundation and harbour facilities.  
Financial data and Technological specific data are essentially the total cost either divided by the electric net capacity, i.e. corresponding to the indicated name plate efficiencies, or by the thermal input. This is to indicate that new plants may not fully take advantage of the technical capabilities for full electricity production capacity. The two cost for electricity and thermal input, respectively, are not to be added up!
- K Note that investments include only two days fuel storage, and more may be optimal, depending on fuel supply opportunities and heat supply obligations, amongst other things.  
The additional investment is listed in the bottom row.
- L Variable O&M cost includes consumables (for FGT etc.), disposal of residues and maintenance cost. Cost for disposal of recovered flue gas condensate is included at a rate of 1.0 €/tonne of condensate. Electricity consumption is not included for CHP, and revenues from sale of electricity and heat are not included. Taxes are not included.

**References**

- 1 Rambøll Danmark, internal evaluation based on either existing projects, supplier offers, or pre-project studies.
- 2 EU-commission, LCP BREF note. Thierry Lecomte, José Félix Ferrería de la Fuente, Frederik Neuwahl, Michele Canova, Antoine Pinasseau, Ivan Jankov, Thomas Brinkmann, Serge Roudier, Luis Delgado Sancho; Best Available Techniques (BAT) Reference Document for Large Combustion Plants; EUR 28836 EN; doi:10.2760/949



## Data sheets Straw CHP, large, 40/80 °C return/forward temperature

| Technology   | Large Straw CHP, 132 MW feed |         |         |         |                    |         |                    |         |      |     |
|--|------------------------------|---------|---------|---------|--------------------|---------|--------------------|---------|------|-----|
|  | 2015                         | 2020    | 2030    | 2050    | Uncertainty (2020) |         | Uncertainty (2050) |         | Note | Ref |
| <b>Energy/technical data</b>                                 |                              |         |         |         | Lower              | Upper   | Lower              | Upper   |      |     |
| Generating capacity for one unit (MWe)                       | 41.6                         | 41.6    | 41.7    | 41.7    | 39.5               | 54.6    | 40.6               | 55.8    | A    |     |
| Electricity efficiency, net (%), name plate                  | 31.5                         | 31.5    | 31.6    | 31.6    | 29                 | 42      | 30                 | 43      | A, H | 1   |
| Electricity efficiency, net (%), annual average              | 29.9                         | 29.9    | 30.0    | 30.0    | 26                 | 40      | 27                 | 41      | A, H | 1   |
| Auxiliary electricity consumption (% of thermal input)       | 2.8                          | 2.8     | 2.8     | 2.8     | 2.1                | 3.1     | 1.7                | 3.3     |      | 1   |
| Cb coefficient (40°C/80°C)                                   | 0.45                         | 0.45    | 0.46    | 0.46    | 0.43               | 0.60    | 0.44               | 0.61    |      |     |
| Cv coefficient (40°C/80°C)                                   | 1                            | 1       | 1       | 1       | 1                  | 1       | 1                  | 1       | I    |     |
| Forced outage (%)  | 3                            | 3       | 3       | 3       | 3                  | 3       | 3                  | 3       |      |     |
| Planned outage (weeks per year)                              | 3.0                          | 3.0     | 3.0     | 3.0     | 2.6                | 3.5     | 2.3                | 3.8     |      |     |
| Technical lifetime (years)                                   | 25                           | 25      | 25      | 25      | 20                 | 35      | 20                 | 35      |      | 1   |
| Construction time (years)                                    | 3                            | 3       | 3       | 3       | 2.5                | 3.5     | 2                  | 3.5     |      | 1   |
| Space requirement (1000 m2/MWe)                              | 0.2                          | 0.2     | 0.2     | 0.2     | 0.2                | 0.3     | 0.2                | 0.3     |      |     |
| <b>Regulation ability</b>                                    |                              |         |         |         |                    |         |                    |         |      |     |
| Primary regulation (% per 30 seconds)                        | 2                            | 2       | 2       | 2       | 2                  | 2       | 2                  | 2       |      |     |
| Secondary regulation (% per minute)                          | 4                            | 4       | 4       | 4       | 4                  | 4       | 4                  | 4       | D    | 1   |
| Minimum load (% of full load)                                | 40                           | 40      | 40      | 40      | 40                 | 40      | 40                 | 40      |      |     |
| Warm start-up time (hours)                                   | 2                            | 2       | 2       | 2       | 2                  | 2       | 2                  | 2       | E    | 1   |
| Cold start-up time (hours)                                   | 8                            | 8       | 8       | 8       | 8                  | 8       | 8                  | 8       |      | 1   |
| <b>Environment</b>   |                              |         |         |         |                    |         |                    |         |      |     |
| SO <sub>2</sub> (degree of desulphuring, %)                  | 95.5                         | 96.4    | 99.1    | 99.8    | 90.9               | 99.8    | 95.5               | 99.9    | F    | 1,2 |
| NO <sub>x</sub> (g per GJ fuel)                              | 40                           | 30      | 30      | 20      | 20                 | 40      | 10                 | 30      | F    | 1,2 |
| CH <sub>4</sub> (g per GJ fuel)                              | 0                            | 0       | 0       | 0       | 0                  | 0       | 0                  | 0       | F    | 1,2 |
| N <sub>2</sub> O (g per GJ fuel)                             | 1                            | 1       | 1       | 1       | 1                  | 3       | 0                  | 1       | F    | 1,2 |
| Particles (g per GJ fuel)                                    | 0.3                          | 0.3     | 0.3     | 0.3     | 0.1                | 2.0     | 0.1                | 1.0     | F    | 1,2 |
| <b>Financial data</b>  |                              |         |         |         |                    |         |                    |         |      |     |
| Nominal investment (M€/MWe)                                  | 3.5                          | 3.4     | 3.2     | 2.9     | 2.9                | 4.0     | 2.3                | 4.0     | J,K  | 1   |
| - of which equipment   | 2.1                          | 2.1     | 2.0     | 1.8     | 1.7                | 2.4     | 1.4                | 2.5     | J,K  |     |
| - of which installation                                      | 1.3                          | 1.3     | 1.2     | 1.1     | 1.1                | 1.5     | 0.9                | 1.5     | J,K  |     |
| Fixed O&M (€/MWe/year)                                       | 126,000                      | 122,000 | 115,000 | 103,000 | 103,000            | 142,000 | 79,000             | 133,000 | J    |     |
| Variable O&M (€/MWh <sub>e</sub> )                           | 2.1                          | 2.1     | 2.1     | 2.1     | 1.6                | 2.4     | 1.4                | 2.6     | L    |     |
| <b>Technology specific data</b>                              |                              |         |         |         |                    |         |                    |         |      |     |
| Steam reheat   | None                         | None    | None    | None    | None               | Yes     | None               | Yes     |      |     |
| Flue gas condensation  | Yes                          | Yes     | Yes     | Yes     | No                 | Yes     | No                 | Yes     | C    |     |
| Combustion air humidification                                | Yes                          | Yes     | Yes     | Yes     | No                 | Yes     | No                 | Yes     | C    |     |
| Output of recovered condensate (tonne/MWh <sub>input</sub> ) | 0.09                         | 0.09    | 0.09    | 0.09    | 0.00               | 0.09    | 0.00               | 0.09    | C, L |     |
| Nominal investment (M€/MW fuel input)                        | 1.09                         | 1.07    | 1.01    | 0.92    | 0.90               | 1.25    | 0.74               | 1.26    | J,K  | 1   |
| - of which equipment   | 0.67                         | 0.66    | 0.63    | 0.57    | 0.55               | 0.77    | 0.45               | 0.78    | K    |     |

|  |        |        |        |        |        |        |        |        |      |   |
|--|--------|--------|--------|--------|--------|--------|--------|--------|------|---|
| - of which installation  | 0.42   | 0.41   | 0.39   | 0.35   | 0.36   | 0.48   | 0.29   | 0.48   | K    |   |
| Fixed O&M (€/MW input/year)  | 39,700 | 38,500 | 36,300 | 32,400 | 32,500 | 44,600 | 24,900 | 41,900 | J    |   |
| Variable O&M (€/MWh input) *   | 0.66   | 0.66   | 0.66   | 0.66   | 0.51   | 0.76   | 0.45   | 0.82   | L    |   |
| Fuel storage specific cost in excess of 2 days (M€/MW_input/storage day) | 0.065  | 0.063  | 0.060  | 0.055  | 0.055  | 0.075  | 0.045  | 0.075  | K    |   |
| Heat efficiency, net (%), name plate                                     | 69.4   | 69.4   | 69.3   | 69.3   | 45     | 72     | 44     | 71     | B, H | 1 |
| Heat efficiency, net (%), annual average                                 | 70.9   | 70.9   | 70.8   | 70.8   | 48     | 74     | 47     | 73     | B, H | 1 |
| Additional heat potential with heat pumps (% of thermal input)           | 1.8    | 1.8    | 1.8    | 1.8    | 1      | 15     | 1      | 15     | C    | 1 |

**Notes:**

- A The boiler in the plant is grate fired producing steam to be used in a subsequent back pressure steam turbine. Though a grate is reasonable flexible with respect to combusting different fuels the fuel feed system will be dependent on the type of fuel used.  
The system is optimised at DH return temperature 40°C and flow 80°C.
- B Through a turbine by-pass all the produced steam energy can be used for District Heat production.
- C Since straw is relatively dry there is often only a minor efficiency advantage in using flue gas condensation. There is though an environmental advantage in having a scrubber in the flue gas stream. Direct condensation and combustion air humidification are included in all cases except in lower/upper range of 2020 and 2050.
- D Secondary regulation normally relates to power production; for this type of plant it may not be of importance since load will normally follow heat consumption.
- E A limiting factor for the hot and cold start-up times is the size of the hot water tank (deaerator).
- F For NO<sub>x</sub>-emissions no lower than 40 g/GJ SNCR is assumed. It is probably necessary to include a tail-end SCR catalyst to fulfil expected BREF requirements, particularly after year 2030.  
This has slight adverse effect on the electricity efficiency.
- G Warm start is starting with a glowing fuel layer on the grate and a warm deaerator.
- H The total efficiency is the sum of electricity efficiency and heat efficiency, applicable for "name plate" and "annual average", respectively. The "annual average" electricity efficiency is lower than "name plate" due to turbine outages and other incidents. The resulting lost power production is recovered as heat. This is why "annual average" heat efficiency is higher than "name plate" heat. Efficiencies refer to lower heating value. The parasitic electricity consumption has been subtracted in the listed electricity efficiencies.
- I The Cv value does not exist for plants with a backpressure turbine or an ORC turbine
- J Investment applies to a standard plant. There could be cost related to the actual project or site that adds to the total investment, e.g. additional fuel storage, facilities for chipping of logs, conditions for foundation and harbour facilities.  
Financial data and Technological specific data are essentially the total cost either divided by the electric net capacity, i.e. corresponding to the indicated name plate efficiencies, or by the thermal input. This is to indicate that new plants may not fully take advantage of the technical capabilities for full electricity production capacity. The two cost for electricity and thermal input, respectively, are not to be added up!
- K Note that investments include only two days fuel storage, and more may be optimal, depending on fuel supply opportunities and heat supply obligations, amongst other things.  
The additional investment is listed in the bottom row.
- L Variable O&M cost includes consumables (for FGT etc.), disposal of residues and maintenance cost. Cost for disposal of recovered flue gas condensate is included at a rate of 1.0 €/tonne of condensate. Electricity consumption is not included for CHP, and revenues from sale of electricity and heat are not included. Taxes are not included.

**References**

- 1 Rambøll Danmark, internal evaluation based on either existing projects, supplier offers, or pre-project studies.
- 2 EU-commission, LCP BREF note. Thierry Lecomte, José Félix Ferrería de la Fuente, Frederik Neuwahl, Michele Canova, Antoine Pinasseau, Ivan Jankov, Thomas Brinkmann, Serge Roudier, Luis Delgado Sancho; Best Available Techniques (BAT) Reference Document for Large Combustion Plants; EUR 28836 EN; doi:10.2760/949

## Data sheets Straw CHP, large, 50/100 °C return/forward temperature

| Technology   | Large Straw CHP, 132 MW feed |         |         |         |                    |         |                    |         | Note | Ref |
|--|------------------------------|---------|---------|---------|--------------------|---------|--------------------|---------|------|-----|
|  | 2015                         | 2020    | 2030    | 2050    | Uncertainty (2020) |         | Uncertainty (2050) |         |      |     |
| <b>Energy/technical data</b>                                 |                              |         |         |         | Lower              | Upper   | Lower              | Upper   |      |     |
| Generating capacity for one unit (MWe)                       | 39.0                         | 39.0    | 39.1    | 39.1    | 36.9               | 52.0    | 38.1               | 53.3    | A    |     |
| Electricity efficiency, net (%), name plate                  | 29.5                         | 29.5    | 29.6    | 29.6    | 27                 | 40      | 28                 | 41      | A, H | 1   |
| Electricity efficiency, net (%), annual average              | 28.1                         | 28.1    | 28.2    | 28.2    | 25                 | 38      | 25                 | 39      | A, H | 1   |
| Auxiliary electricity consumption (% of thermal input)       | 2.9                          | 2.9     | 2.9     | 2.9     | 2.1                | 3.2     | 1.7                | 3.3     |      | 1   |
| Cb coefficient (50°C/100°C)                                  | 0.43                         | 0.43    | 0.43    | 0.43    | 0.41               | 0.57    | 0.42               | 0.59    |      |     |
| Cv coefficient (50°C/100°C)                                  | 1                            | 1       | 1       | 1       | 1                  | 1       | 1                  | 1       | I    |     |
| Forced outage (%)  | 3                            | 3       | 3       | 3       | 3                  | 3       | 3                  | 3       |      |     |
| Planned outage (weeks per year)                              | 3.0                          | 3.0     | 3.0     | 3.0     | 2.6                | 3.5     | 2.3                | 3.8     |      |     |
| Technical lifetime (years)                                   | 25                           | 25      | 25      | 25      | 20                 | 35      | 20                 | 35      |      | 1   |
| Construction time (years)                                    | 3                            | 3       | 3       | 3       | 2.5                | 3.5     | 2                  | 3.5     |      | 1   |
| Space requirement (1000 m2/MWe)                              | 0.3                          | 0.3     | 0.3     | 0.3     | 0.2                | 0.3     | 0.2                | 0.3     |      |     |
| <b>Regulation ability</b>                                    |                              |         |         |         |                    |         |                    |         |      |     |
| Primary regulation (% per 30 seconds)                        | 2                            | 2       | 2       | 2       | 2                  | 2       | 2                  | 2       |      |     |
| Secondary regulation (% per minute)                          | 4                            | 4       | 4       | 4       | 4                  | 4       | 4                  | 4       | D    | 1   |
| Minimum load (% of full load)                                | 40                           | 40      | 40      | 40      | 40                 | 40      | 40                 | 40      |      |     |
| Warm start-up time (hours)                                   | 2                            | 2       | 2       | 2       | 2                  | 2       | 2                  | 2       | E    | 1   |
| Cold start-up time (hours)                                   | 8                            | 8       | 8       | 8       | 8                  | 8       | 8                  | 8       |      | 1   |
| <b>Environment</b>   |                              |         |         |         |                    |         |                    |         |      |     |
| SO <sub>2</sub> (degree of desulphuring, %)                  | 95.5                         | 96.4    | 99.1    | 99.8    | 90.9               | 99.8    | 95.5               | 99.9    | F    | 1,2 |
| NO <sub>x</sub> (g per GJ fuel)                              | 40                           | 30      | 30      | 20      | 20                 | 40      | 10                 | 30      | F    | 1,2 |
| CH <sub>4</sub> (g per GJ fuel)                              | 0                            | 0       | 0       | 0       | 0                  | 0       | 0                  | 0       | F    | 1,2 |
| N <sub>2</sub> O (g per GJ fuel)                             | 1                            | 1       | 1       | 1       | 1                  | 3       | 0                  | 1       | F    | 1,2 |
| Particles (g per GJ fuel)                                    | 0.3                          | 0.3     | 0.3     | 0.3     | 0.1                | 2.0     | 0.1                | 1.0     | F    | 1,2 |
| <b>Financial data</b>  |                              |         |         |         |                    |         |                    |         |      |     |
| Nominal investment (M€/MWe)                                  | 3.7                          | 3.6     | 3.4     | 3.1     | 3.0                | 4.2     | 2.5                | 4.3     | J,K  | 1   |
| - of which equipment   | 2.3                          | 2.2     | 2.1     | 1.9     | 1.8                | 2.6     | 1.5                | 2.6     | J,K  |     |
| - of which installation                                      | 1.4                          | 1.4     | 1.3     | 1.2     | 1.2                | 1.6     | 1.0                | 1.6     | J,K  |     |
| Fixed O&M (€/MWe/year)                                       | 134,000                      | 130,000 | 123,000 | 109,000 | 110,000            | 151,000 | 84,000             | 142,000 | J    |     |
| Variable O&M (€/MWh <sub>e</sub> )                           | 2.1                          | 2.1     | 2.1     | 2.1     | 1.7                | 2.5     | 1.5                | 2.7     | L    |     |
| <b>Technology specific data</b>                              |                              |         |         |         |                    |         |                    |         |      |     |
| Steam reheat   | None                         | None    | None    | None    | None               | Yes     | None               | Yes     |      |     |
| Flue gas condensation  | Yes                          | Yes     | Yes     | Yes     | No                 | Yes     | No                 | Yes     | C    |     |
| Combustion air humidification                                | Yes                          | Yes     | Yes     | Yes     | No                 | Yes     | No                 | Yes     | C    |     |
| Output of recovered condensate (tonne/MWh <sub>input</sub> ) | 0.06                         | 0.06    | 0.06    | 0.06    | 0.00               | 0.06    | 0.00               | 0.06    | C, L |     |
| Nominal investment (M€/MW fuel input)                        | 1.09                         | 1.07    | 1.01    | 0.92    | 0.90               | 1.25    | 0.74               | 1.26    | J,K  | 1   |
| - of which equipment   | 0.67                         | 0.66    | 0.63    | 0.57    | 0.55               | 0.77    | 0.45               | 0.78    | K    |     |

|  |        |        |        |        |        |        |        |        |      |   |
|--|--------|--------|--------|--------|--------|--------|--------|--------|------|---|
| - of which installation  | 0.42   | 0.41   | 0.39   | 0.35   | 0.36   | 0.48   | 0.29   | 0.48   | K    |   |
| Fixed O&M (€/MW input/year)  | 39,700 | 38,500 | 36,300 | 32,400 | 32,500 | 44,600 | 24,900 | 41,900 | J    |   |
| Variable O&M (€/MWh input) *   | 0.63   | 0.63   | 0.63   | 0.63   | 0.51   | 0.73   | 0.45   | 0.79   | L    |   |
| Fuel storage specific cost in excess of 2 days (M€/MW_input/storage day) | 0.065  | 0.063  | 0.060  | 0.055  | 0.055  | 0.075  | 0.045  | 0.075  | K    |   |
| Heat efficiency, net (%), name plate                                     | 68.9   | 68.9   | 68.8   | 68.8   | 47     | 71     | 46     | 70     | B, H | 1 |
| Heat efficiency, net (%), annual average                                 | 70.3   | 70.3   | 70.3   | 70.3   | 49     | 73     | 49     | 72     | B, H | 1 |
| Additional heat potential with heat pumps (% of thermal input)           | 4.2    | 4.2    | 4.2    | 4.2    | 4      | 15     | 4      | 15     | C    | 1 |

**Notes:**

- A The boiler in the plant is grate fired producing steam to be used in a subsequent backpressure steam turbine. Though a grate is reasonable flexible with respect to combusting different fuels the fuel feed system will be dependent on the type of fuel used.  
The system is optimised at DH return temperature 50°C and flow 100°C.
- B Through a turbine by-pass all the produced steam energy can be used for District Heat production.
- C Since straw is relatively dry there is often only a minor efficiency advantage in using flue gas condensation. There is though an environmental advantage in having a scrubber in the flue gas stream. Direct condensation and combustion air humidification are included in all cases except in lower/upper range of 2020 and 2050.
- D Secondary regulation normally relates to power production; for this type of plant it may not be of importance since load will normally follow heat consumption.
- E A limiting factor for the hot and cold start-up times is the size of the hot water tank (deaerator).
- F For NO<sub>x</sub>-emissions no lower than 40 g/GJ SNCR is assumed. It is probably necessary to include a tail-end SCR catalyst to fulfil expected BREF requirements, particularly after year 2030.  
This has slight adverse effect on the electricity efficiency.
- G Warm start is starting with a glowing fuel layer on the grate and a warm deaerator.
- H The total efficiency is the sum of electricity efficiency and heat efficiency, applicable for "name plate" and "annual average", respectively. The "annual average" electricity efficiency is lower than "name plate" due to turbine outages and other incidents. The resulting lost power production is recovered as heat. This is why "annual average" heat efficiency is higher than "name plate" heat. Efficiencies refer to lower heating value. The parasitic electricity consumption has been subtracted in the listed electricity efficiencies.
- I The Cv value does not exist for plants with a backpressure turbine or an ORC turbine
- J Investment applies to a standard plant. There could be cost related to the actual project or site that adds to the total investment, e.g. additional fuel storage, facilities for chipping of logs, conditions for foundation and harbour facilities.  
Financial data and Technological specific data are essentially the total cost either divided by the electric net capacity, i.e. corresponding to the indicated name plate efficiencies, or by the thermal input. This is to indicate that new plants may not fully take advantage of the technical capabilities for full electricity production capacity. The two cost for electricity and thermal input, respectively, are not to be added up!
- K Note that investments include only two days fuel storage, and more may be optimal, depending on fuel supply opportunities and heat supply obligations, amongst other things.  
The additional investment is listed in the bottom row.
- L Variable O&M cost includes consumables (for FGT etc.), disposal of residues and maintenance cost. Cost for disposal of recovered flue gas condensate is included at a rate of 1.0 €/tonne of condensate. Electricity consumption is not included for CHP, and revenues from sale of electricity and heat are not included. Taxes are not included.

**References**

- 1 Rambøll Danmark, internal evaluation based on either existing projects, supplier offers, or pre-project studies.
- 2 EU-commission, LCP BREF note. Thierry Lecomte, José Félix Ferrería de la Fuente, Frederik Neuwahl, Michele Canova, Antoine Pinasseau, Ivan Jankov, Thomas Brinkmann, Serge Roudier, Luis Delgado Sancho; Best Available Techniques (BAT) Reference Document for Large Combustion Plants; EUR 28836 EN; doi:10.2760/949

## Data sheets Wood Chips, HOP, Small

| Technology  | Wood Chips, DH-Small, 6 MW feed |       |       |       |                    |       |                    |       |      |     |
|---|---------------------------------|-------|-------|-------|--------------------|-------|--------------------|-------|------|-----|
|   | 2015                            | 2020  | 2030  | 2050  | Uncertainty (2020) |       | Uncertainty (2050) |       | Note | Ref |
| <b>Energy/technical data</b>                              |                                 |       |       |       | Lower              | Upper | Lower              | Upper |      |     |
| Heat generation capacity for one unit (MW)                | 6.8                             | 6.8   | 6.8   | 6.8   | 5.3                | 6.9   | 5.3                | 6.9   | A    | 1   |
| Total efficiency, net (%), name plate                     | 114.0                           | 114.0 | 114.0 | 114.0 | 89                 | 115   | 89                 | 115   | B,C  | 1   |
| Total efficiency, net (%), annual average                 | 114.0                           | 114.0 | 114.0 | 114.0 | 89                 | 115   | 89                 | 115   | B,C  | 1   |
| Auxiliary electricity consumption (% of heat gen)         | 2.2                             | 2.2   | 2.2   | 2.2   | 2.1                | 2.5   | 1.7                | 2.5   | C,K  |     |
| Forced outage (%)   | 3.0                             | 3.0   | 3.0   | 3.0   | 3.0                | 3.0   | 3.0                | 3.0   |      |     |
| Planned outage (weeks per year)                           | 2.0                             | 2.0   | 2.0   | 2.0   | 1.7                | 2.3   | 1.5                | 2.5   |      |     |
| Technical lifetime (years)                                | 25.0                            | 25.0  | 25.0  | 25.0  | 20.0               | 35.0  | 20.0               | 35.0  |      | 1   |
| Construction time (years)                                 | 1.0                             | 1.0   | 1.0   | 1.0   | 0.5                | 1.5   | 0.5                | 1.5   |      | 1   |
| Space requirement (1000 m <sup>2</sup> /MWth heat output) | 0.2                             | 0.2   | 0.2   | 0.2   | 0.2                | 0.3   | 0.2                | 0.3   |      |     |
| <b>Regulation ability</b>                                 |                                 |       |       |       |                    |       |                    |       |      |     |
| Primary regulation (% per 30 seconds)                     | NA                              | NA    | NA    | NA    | NA                 | NA    | NA                 | NA    |      |     |
| Secondary regulation (% per minute)                       | 10.0                            | 10.0  | 10.0  | 10.0  | 10.0               | 10.0  | 10.0               | 10.0  | E    | 1   |
| Minimum load (% of full load)                             | 20                              | 20    | 20    | 20    | 20                 | 20    | 20                 | 20    | E    | 1   |
| Warm start-up time (hours)                                | 0.3                             | 0.3   | 0.3   | 0.3   | 0.3                | 0.3   | 0.3                | 0.3   | H    | 1   |
| Cold start-up time (hours)                                | 0.5                             | 0.5   | 0.5   | 0.5   | 0.5                | 0.5   | 0.5                | 0.5   |      | 1   |
| <b>Environment</b>  |                                 |       |       |       |                    |       |                    |       |      |     |
| SO <sub>2</sub> (degree of desulphuring, %)               | 98.0                            | 98.0  | 98.0  | 98.0  | 89.9               | 99.0  | 98.0               | 99.0  | G    | 1   |
| NO <sub>x</sub> (g per GJ fuel)                           | 90                              | 60    | 50    | 40    | 40                 | 80    | 30                 | 40    | I    | 2   |
| CH <sub>4</sub> (g per GJ fuel)                           | 16                              | 11    | 8     | 4     | 4                  | 16    | 2                  | 16    | I    | 2   |
| N <sub>2</sub> O (g per GJ fuel)                          | 4                               | 3     | 3     | 1     | 1                  | 4     | 1                  | 4     | I    | 2   |
| Particles (g per GJ fuel)                                 | 2.0                             | 0.3   | 0.3   | 0.3   | 0.1                | 2.0   | 0.1                | 1.0   | I    | 2   |
| <b>Financial data</b>                                     |                                 |       |       |       |                    |       |                    |       |      |     |
| Nominal investment (M€/MWth - heat output)                | 0.71                            | 0.69  | 0.66  | 0.59  | 0.60               | 0.81  | 0.49               | 0.82  | F, L |     |
| - of which equipment                                      | 0.41                            | 0.40  | 0.38  | 0.34  | 0.35               | 0.47  | 0.28               | 0.47  | F, L |     |
| - of which installation                                   | 0.30                            | 0.29  | 0.28  | 0.25  | 0.25               | 0.34  | 0.21               | 0.35  | F, L |     |



|  |        |        |        |        |        |        |        |        |      |   |
|--|--------|--------|--------|--------|--------|--------|--------|--------|------|---|
| Fixed O&M (€/MWh/year), heat output                                      | 33,000 | 32,500 | 31,500 | 29,600 | 27,800 | 37,700 | 22,800 | 38,000 |      |   |
| Variable O&M (€/MWh) heat output   | 2.59   | 2.72   | 3.43   | 3.78   | 2.34   | 3.71   | 3.29   | 5.22   | M    |   |
| - of which is electricity costs (€/MWh-heat)                             | 1.40   | 1.53   | 2.24   | 2.59   | 1.51   | 1.99   | 2.56   | 3.38   | M    |   |
| - of which is other O&M costs (€/MWh-heat)                               | 1.19   | 1.19   | 1.19   | 1.19   | 0.83   | 1.72   | 0.73   | 1.84   | M    |   |
| <b>Technology specific data</b>  |        |        |        |        |        |        |        |        |      |   |
| Flue gas condensation  | Yes    | Yes    | Yes    | Yes    | No     | Yes    | No     | Yes    | D, J |   |
| Combustion air humidification  | Yes    | Yes    | Yes    | Yes    | No     | Yes    | No     | Yes    | D, J |   |
| Output of recovered condensate (tonne/MWh_input)                         | 0.25   | 0.25   | 0.25   | 0.25   | 0.00   | 0.25   | 0.00   | 0.25   | D    |   |
| Nominal investment (M€/MW fuel input)                                    | 0.81   | 0.79   | 0.75   | 0.68   | 0.69   | 0.93   | 0.56   | 0.94   | J, L | 1 |
| - of which equipment   | 0.47   | 0.46   | 0.43   | 0.39   | 0.40   | 0.54   | 0.32   | 0.54   | L    |   |
| - of which installation  | 0.34   | 0.33   | 0.32   | 0.29   | 0.29   | 0.39   | 0.24   | 0.39   | L    |   |
| Fixed O&M (€/MW input/year)  | 37,700 | 37,100 | 35,900 | 33,700 | 31,700 | 42,900 | 26,000 | 43,300 |      |   |
| Variable O&M, including electricity (€/MWh input)                        | 3.0    | 3.1    | 3.9    | 4.3    | 2.7    | 3.3    | 3.8    | 4.7    | M    |   |
| Fuel storage specific cost in excess of 2 days (M€/MW_input/storage day) | 0.020  | 0.020  | 0.019  | 0.017  | 0.017  | 0.023  | 0.014  | 0.023  | L    |   |
| Additional heat potential with heat pumps (% of thermal input)           | 1.9    | 1.9    | 1.9    | 1.9    | 1      | 26     | 1      | 26     | D    | 1 |

**Notes:**

- A The plant is directly producing hot water for District Heating by burning fuel on a grate.  
The system is optimised at DH return temperature 40°C and flow 80°C.
- B Boilers up to 20 MW fuel input for hot water production are more or less standardized products with a high degree of fuel flexibility (type of biomass, humidity etc.)
- C Efficiencies refer to lower heating value. The stated total efficiency does NOT consider auxiliary electricity consumption. It describes the total net amount of heat produced at the plant. This is contrary to CHP where the auxiliary electricity is subtracted from the production to yield the net electricity efficiency. Direct condensation and combustion air humidification are included in all cases except in lower range of 2020 and 2050. The colder the return temperature of the district heating, the higher the total efficiency at direct condensation.
- D Additional heat potential for heat pump is the flue gas condensation potential remaining after the direct condensation stage (condensation by heat exchange with DH-water). Direct condensation and combustion air humidification are included in all cases except in lower/upper range of 2020 and 2050.
- E Load control of the heat production is important and units of this size can make rapid load variations. Similarly, the minimum load is quite low
- F Reference to heat output because of the lack of electricity production
- G assuming content of sulphur in fuel of 20 g/GJ
- H Warm start is starting with a glowing fuel layer on the grate.

- I Emissions shall comply with the order of the Danish EPA no 1535 of 2019 (Bekendtgørelse om miljøkrav for mellemstore fyringsanlæg), implementing the Medium Combustion Directive, Directive (EU) 2015/2193 of the European Parliament and of the Council of 25 November 2015 on the limitation of emissions of certain pollutants into the air from medium combustion plants..  
It is anticipated that for the smaller units the supplier has an SNCR solution to reduce NOx emissions sufficiently. However, to reach NOx-levels below 40 g/GJ SCR is assumed.
- J The nominal investment for small HOPs is in the range 0.6 to 1.1 M€/MWth
- K Result of model calculation, there are reports of DH plants operating at lower power consumption, down to 1% of heat generation.
- L Note that investments include only two days fuel storage, and more may be optimal, depending on fuel supply opportunities and heat supply obligations, amongst other things.  
The additional investment is listed in the bottom row.
- M Variable O&M cost includes consumables (for FGT etc.), disposal of residues, small share of staff-cost and maintenance cost. Electricity consumption is included for DH and associated cost listed separately, in addition. Cost for disposal of recovered flue gas condensate is included at a rate of 1.0 €/tonne of condensate. Revenues from sale of heat are not included. Taxes are not included. The cost of auxiliary electricity consumption is calculated using the following electricity prices in €/MWh: 2015: 63, 2020: 69, 2030: 101, 2050: 117. These prices include production costs and transport tariffs, but not any taxes or subsidies for renewable energy.

### References:

- 1 Rambøll Danmark, internal evaluation based on either existing projects, supplier offers, or pre-project studies.
- 2 Estimated from emission factors of 2006: 81 g/GJ NOx, 1.9 g/GJ for SO2, <1 g/GJ for CH4, 0.8 g/GJ for N2O, 10 g/GJ for Particles; cf. Nielsen, M., Nielsen, O.-K. & Thomsen, M. 2010: Emissions from decentralised CHP plants 2007 - Energinet.dk Environmental project no. 07/1882. Project report 5 – Emission factors and emission inventory for decentralised CHP production. National Environmental Research Institute, Aarhus University. 113 pp. – NERI Technical report No. 786. <http://www.dmu.dk/Pub/FR786.pdf>.

## Data sheets Wood Chips, HOP, Medium

| Technology   | Wood Chips, DH-Medium, 45 MW feed |        |        |        |                    |                    |              |              |      |   |
|--|-----------------------------------|--------|--------|--------|--------------------|--------------------|--------------|--------------|------|---|
|  | 2015                              | 2020   | 2030   | 2050   | Uncertainty (2020) | Uncertainty (2050) | Note         | Ref          |      |   |
| <b>Energy/technical data</b>                                 |                                   |        |        |        | <b>Lower</b>       | <b>Upper</b>       | <b>Lower</b> | <b>Upper</b> |      |   |
| Heat generation capacity for one unit (MW)                   | 51.6                              | 51.6   | 51.6   | 51.6   | 40.4               | 51.8               | 39.7         | 51.9         | A    | 1 |
| Total efficiency, net (%), name plate                        | 114.8                             | 114.8  | 114.8  | 114.7  | 89                 | 116                | 88           | 116          | B,C  | 1 |
| Total efficiency, net (%), annual average                    | 114.8                             | 114.8  | 114.8  | 114.7  | 89                 | 116                | 88           | 116          | B,C  | 1 |
| Auxiliary electricity consumption (% of heat gen)            | 2.2                               | 2.2    | 2.2    | 2.2    | 2.1                | 2.5                | 1.7          | 2.5          | C,K  |   |
| Forced outage (%)  | 3.0                               | 3.0    | 3.0    | 3.0    | 3.0                | 3.0                | 3.0          | 3.0          |      |   |
| Planned outage (weeks per year)                              | 2.0                               | 2.0    | 2.0    | 2.0    | 1.7                | 2.3                | 1.5          | 2.5          |      |   |
| Technical lifetime (years)                                   | 25.0                              | 25.0   | 25.0   | 25.0   | 20.0               | 35.0               | 20.0         | 35.0         |      | 1 |
| Construction time (years)                                    | 2.0                               | 2.0    | 2.0    | 2.0    | 1.5                | 2.5                | 1.5          | 2.5          |      | 1 |
| Space requirement (1000 m <sup>2</sup> /MWth heat output)    | 0.06                              | 0.06   | 0.06   | 0.06   | 0.05               | 0.07               | 0.04         | 0.07         |      |   |
| <b>Regulation ability</b>                                    |                                   |        |        |        |                    |                    |              |              |      |   |
| Primary regulation (% per 30 seconds)                        | NA                                | NA     | NA     | NA     | NA                 | NA                 | NA           | NA           |      |   |
| Secondary regulation (% per minute)                          | 10.0                              | 10.0   | 10.0   | 10.0   | 10.0               | 10.0               | 10.0         | 10.0         | E    | 1 |
| Minimum load (% of full load)                                | 40                                | 40     | 40     | 40     | 40                 | 40                 | 40           | 40           |      | 1 |
| Warm start-up time (hours)                                   | 2.0                               | 2.0    | 2.0    | 2.0    | 2.0                | 2.0                | 2.0          | 2.0          | H    | 1 |
| Cold start-up time (hours)                                   | 8.0                               | 8.0    | 8.0    | 8.0    | 8.0                | 8.0                | 8.0          | 8.0          |      | 1 |
| <b>Environment</b>   |                                   |        |        |        |                    |                    |              |              |      |   |
| SO <sub>2</sub> (degree of desulphuring, %)                  | 98.0                              | 98.0   | 98.0   | 98.0   | 94.9               | 99.0               | 98.0         | 99.0         | G    | 1 |
| NO <sub>x</sub> (g per GJ fuel)                              | 90                                | 60     | 40     | 30     | 40                 | 80                 | 20           | 40           | I    | 2 |
| CH <sub>4</sub> (g per GJ fuel)                              | 16                                | 11     | 8      | 4      | 4                  | 16                 | 2            | 16           | I    | 2 |
| N <sub>2</sub> O (g per GJ fuel)                             | 1                                 | 1      | 1      | 0      | 0                  | 1                  | 0            | 1            | I    | 2 |
| Particles (g per GJ fuel)                                    | 2.0                               | 0.3    | 0.3    | 0.3    | 0.1                | 2.0                | 0.1          | 1.0          | I    | 2 |
| <b>Financial data</b>  |                                   |        |        |        |                    |                    |              |              |      |   |
| Nominal investment (M€/MWth - heat output)                   | 0.51                              | 0.49   | 0.47   | 0.45   | 0.43               | 0.58               | 0.35         | 0.62         | F, L |   |
| - of which equipment   | 0.37                              | 0.36   | 0.34   | 0.34   | 0.31               | 0.43               | 0.26         | 0.46         | F, L |   |
| - of which installation                                      | 0.14                              | 0.13   | 0.13   | 0.11   | 0.12               | 0.16               | 0.09         | 0.16         | F, L |   |
| Fixed O&M (€/MWth/year), heat output                         | 42,800                            | 42,000 | 40,500 | 38,200 | 35,800             | 48,500             | 28,800       | 48,500       |      |   |
| Variable O&M (€/MWh) heat output                             | 2.6                               | 2.7    | 3.4    | 3.8    | 2.3                | 3.7                | 3.3          | 5.3          | M    |   |
| - of which is electricity costs (€/MWh-heat)                 | 1.4                               | 1.5    | 2.2    | 2.6    | 1.5                | 2.0                | 2.5          | 3.4          | M    |   |
| - of which is other O&M costs (€/MWh-heat)                   | 1.2                               | 1.2    | 1.2    | 1.2    | 0.8                | 1.7                | 0.7          | 1.9          | M    |   |
| <b>Technology specific data</b>                              |                                   |        |        |        |                    |                    |              |              |      |   |
| Flue gas condensation  | Yes                               | Yes    | Yes    | Yes    | No                 | Yes                | No           | Yes          | D    |   |
| Combustion air humidification                                | Yes                               | Yes    | Yes    | Yes    | No                 | Yes                | No           | Yes          | D    |   |
| Output of recovered condensate (tonne/MWh <sub>input</sub> ) | 0.25                              | 0.25   | 0.25   | 0.25   | 0.00               | 0.25               | 0.00         | 0.25         | D    |   |
| Nominal investment (M€/MW fuel input)                        | 0.58                              | 0.57   | 0.54   | 0.52   | 0.49               | 0.67               | 0.40         | 0.71         | L    | 1 |
| - of which equipment   | 0.42                              | 0.41   | 0.39   | 0.39   | 0.36               | 0.49               | 0.30         | 0.53         | L    |   |

|  |        |        |        |        |        |        |        |        |   |   |
|--|--------|--------|--------|--------|--------|--------|--------|--------|---|---|
| - of which installation  | 0.16   | 0.15   | 0.14   | 0.13   | 0.13   | 0.18   | 0.11   | 0.18   | L |   |
| Fixed O&M (€/MW input/year)  | 49,100 | 48,200 | 46,400 | 43,900 | 41,100 | 55,600 | 33,000 | 55,700 |   |   |
| Variable O&M, including electricity (€/MWh input)                        | 3.0    | 3.1    | 3.9    | 4.3    | 2.7    | 3.3    | 3.8    | 4.7    | M |   |
| Fuel storage specific cost in excess of 2 days (M€/MW_input/storage day) | 0.017  | 0.017  | 0.016  | 0.014  | 0.014  | 0.020  | 0.012  | 0.020  | L |   |
| Additional heat potential with heat pumps (% of thermal input)           | 1.9    | 1.9    | 1.9    | 1.9    | 1      | 26     | 1      | 28     | D | 1 |

**Notes:**

- A The plant is directly producing hot water for District Heating by burning fuel on a grate as the basis assumption. Fluid-bed combustion technology may be an alternative. It can be assumed that the data for this does not differ significantly from grate fired boilers. Data in this sheet is applicable for plants in the range of 30-49,9 MW fired capacity (heat input).  
  
The system is optimised at DH return temperature 40°C and flow 80°C.
- B Boilers larger than approx. 20 MW fuel input for hot water production are designed-for-purpose products with a high degree of fuel flexibility (type of biomass, humidity etc.)
- C Efficiencies refer to lower heating value. The stated total efficiency does NOT consider auxiliary electricity consumption. It describes the total net amount of heat produced at the plant. This is contrary to CHP where the auxiliary electricity is subtracted from the production to yield the net electricity efficiency. Direct condensation and combustion air humidification are included in all cases except in lower range of 2020 and 2050. The colder the return temperature of the district heating, the higher the total efficiency at direct condensation.
- D Additional heat potential for heat pump is the flue gas condensation potential remaining after the direct condensation stage (condensation by heat exchange with DH-water). Direct condensation and combustion air humidification are included in all cases except in lower/upper range of 2020 and 2050.
- E Load control of the heat production is important and units of this size can make rapid load variations.
- F Reference to heat output because of the lack of electricity production
- G assuming content of sulphur in fuel of 20 g/GJ
- H Warm start is starting with a glowing fuel layer on the grate.
- I Emissions shall comply with the order of the Danish EPA no 1535 of 2019 (Bekendtgørelse om miljøkrav for mellemstore fyringsanlæg), implementing the Medium Combustion Directive, Directive (EU) 2015/2193 of the European Parliament and of the Council of 25 November 2015 on the limitation of emissions of certain pollutants into the air from medium combustion plants..  
It is anticipated that for the smaller units the supplier has an SNCR solution to reduce NOx emissions sufficiently. However, to reach NOx-levels below 40 g/GJ SCR is assumed.
- J
- K
- L Note that investments include only two days fuel storage, and more may be optimal, depending on fuel supply opportunities and heat supply obligations, amongst other things.  
The additional investment is listed in the bottom row.
- M Variable O&M cost includes consumables (for FGT etc.), disposal of residues, small share of staff-cost and maintenance cost. Electricity consumption is included for DH and associated cost listed separately, in addition. Cost for disposal of recovered flue gas condensate is included at a rate of 1.0 €/tonne of condensate. Revenues from sale of heat are not included. Taxes are not included. The cost of auxiliary electricity consumption is calculated using the following electricity prices in €/MWh: 2015: 63, 2020: 69, 2030: 101, 2050: 117. These prices include production costs and transport tariffs, but not any taxes or subsidies for renewable energy.

**References:**

- 1 Rambøll Danmark, internal evaluation based on either existing projects, supplier and operator information, or pre-project studies.
- 2 Estimated from emission factors of 2006: 81 g/GJ NO<sub>x</sub>, 1.9 g/GJ for SO<sub>2</sub>, <1 g/GJ for CH<sub>4</sub>, 0.8 g/GJ for N<sub>2</sub>O, 10 g/GJ for Particles; cf. Nielsen, M., Nielsen, O.-K. & Thomsen, M. 2010: Emissions from decentralised CHP plants 2007 - Energinet.dk Environmental project no. 07/1882. Project report 5 – Emission factors and emission inventory for decentralised CHP production. National Environmental Research Institute, Aarhus University. 113 pp. – NERI Technical report No. 786. <http://www.dmu.dk/Pub/FR786.pdf>.

## Data sheets Wood Chips, HOP, Large

| Technology  | Wood Chips, DH-Large, 90 MW feed |        |        |        |                    |              |                    |              |      |     |
|---|----------------------------------|--------|--------|--------|--------------------|--------------|--------------------|--------------|------|-----|
|   | 2015                             | 2020   | 2030   | 2050   | Uncertainty (2020) |              | Uncertainty (2050) |              | Note | Ref |
| <b>Energy/technical data</b>                      |                                  |        |        |        | <b>Lower</b>       | <b>Upper</b> | <b>Lower</b>       | <b>Upper</b> |      |     |
| Heat generation capacity for one unit (MW)        | 103.4                            | 103.4  | 103.4  | 103.4  | 80.9               | 103.8        | 79.5               | 103.9        | A    | 1   |
| Total efficiency, net (%), name plate             | 114.9                            | 114.9  | 114.9  | 114.9  | 89                 | 116          | 88                 | 116          | B,C  | 1   |
| Total efficiency, net (%), annual average         | 114.9                            | 114.9  | 114.9  | 114.9  | 89                 | 116          | 88                 | 116          | B,C  | 1   |
| Auxiliary electricity consumption (% of heat gen) | 2.2                              | 2.2    | 2.2    | 2.2    | 2.1                | 2.5          | 1.7                | 2.5          | C,K  |     |
| Forced outage (%)                                 | 3.0                              | 3.0    | 3.0    | 3.0    | 3.0                | 3.0          | 3.0                | 3.0          |      |     |
| Planned outage (weeks per year)                   | 2.0                              | 2.0    | 2.0    | 2.0    | 1.7                | 2.3          | 1.5                | 2.5          |      |     |
| Technical lifetime (years)                        | 25.0                             | 25.0   | 25.0   | 25.0   | 20.0               | 35.0         | 20.0               | 35.0         |      | 1   |
| Construction time (years)                         | 2.5                              | 2.5    | 2.5    | 2.5    | 2.0                | 3.0          | 2.0                | 3.0          |      | 1   |
| Space requirement (1000 m2/MWth heat output)      | 0.05                             | 0.05   | 0.05   | 0.05   | 0.04               | 0.06         | 0.04               | 0.06         |      |     |
| <b>Regulation ability</b>                         |                                  |        |        |        |                    |              |                    |              |      |     |
| Primary regulation (% per 30 seconds)             | NA                               | NA     | NA     | NA     | NA                 | NA           | NA                 | NA           |      |     |
| Secondary regulation (% per minute)               | 10.0                             | 10.0   | 10.0   | 10.0   | 10.0               | 10.0         | 10.0               | 10.0         | E    | 1   |
| Minimum load (% of full load)                     | 40                               | 40     | 40     | 40     | 40                 | 40           | 40                 | 40           |      | 1   |
| Warm start-up time (hours)                        | 2.0                              | 2.0    | 2.0    | 2.0    | 2.0                | 2.0          | 2.0                | 2.0          | H    | 1   |
| Cold start-up time (hours)                        | 8.0                              | 8.0    | 8.0    | 8.0    | 8.0                | 8.0          | 8.0                | 8.0          |      | 1   |
| <b>Environment</b>                                |                                  |        |        |        |                    |              |                    |              |      |     |
| SO <sub>2</sub> (degree of desulphuring, %)       | 98.0                             | 98.0   | 98.0   | 98.0   | 94.9               | 99.0         | 98.0               | 99.0         | G    | 1   |
| NO <sub>x</sub> (g per GJ fuel)                   | 90                               | 60     | 40     | 20     | 40                 | 60           | 20                 | 40           |      | 2,3 |
| CH <sub>4</sub> (g per GJ fuel)                   | 3                                | 2      | 2      | 1      | 1                  | 3            | 0                  | 3            |      | 3   |
| N <sub>2</sub> O (g per GJ fuel)                  | 1                                | 1      | 1      | 0      | 0                  | 1            | 0                  | 1            |      | 3   |
| Particles (g per GJ fuel)                         | 2.0                              | 0.3    | 0.3    | 0.3    | 0.1                | 2.0          | 0.1                | 1.0          |      | 3   |
| <b>Financial data</b>                             |                                  |        |        |        |                    |              |                    |              |      |     |
| Nominal investment (M€/MWth - heat output)        | 0.45                             | 0.44   | 0.42   | 0.40   | 0.38               | 0.52         | 0.31               | 0.55         | F, L |     |
| - of which equipment                              | 0.34                             | 0.33   | 0.31   | 0.31   | 0.29               | 0.39         | 0.24               | 0.42         | F, L |     |
| - of which installation                           | 0.11                             | 0.11   | 0.10   | 0.09   | 0.09               | 0.13         | 0.08               | 0.13         | F, L |     |
| Fixed O&M (€/MWth/year), heat output              | 35,200                           | 34,600 | 33,300 | 31,400 | 29,500             | 39,900       | 23,600             | 39,900       |      |     |
| Variable O&M (€/MWh) heat output                  | 2.6                              | 2.7    | 3.4    | 3.8    | 2.3                | 3.7          | 3.3                | 5.3          | M    |     |
| - of which is electricity costs (€/MWh-heat)      | 1.4                              | 1.5    | 2.2    | 2.6    | 1.5                | 2.0          | 2.5                | 3.4          | M    |     |
| - of which is other O&M costs (€/MWh-heat)        | 1.2                              | 1.2    | 1.2    | 1.2    | 0.8                | 1.7          | 0.7                | 1.9          | M    |     |
| <b>Technology specific data</b>                   |                                  |        |        |        |                    |              |                    |              |      |     |
| Flue gas condensation                             | Yes                              | Yes    | Yes    | Yes    | No                 | Yes          | No                 | Yes          | D    |     |
| Combustion air humidification                     | Yes                              | Yes    | Yes    | Yes    | No                 | Yes          | No                 | Yes          | D    |     |
| Output of recovered condensate (tonne/MWh_input)  | 0.25                             | 0.25   | 0.25   | 0.25   | 0.00               | 0.25         | 0.00               | 0.25         | D    |     |
| Nominal investment (M€/MW fuel input)             | 0.52                             | 0.50   | 0.48   | 0.46   | 0.44               | 0.60         | 0.36               | 0.63         | L    | 1   |
| - of which equipment                              | 0.39                             | 0.38   | 0.36   | 0.36   | 0.33               | 0.45         | 0.27               | 0.48         | L    |     |
| - of which installation                           | 0.13                             | 0.12   | 0.12   | 0.11   | 0.11               | 0.15         | 0.09               | 0.15         | L    |     |

|  |        |        |        |        |        |        |        |        |   |   |
|--|--------|--------|--------|--------|--------|--------|--------|--------|---|---|
| Fixed O&M (€/MW input/year)  | 40,500 | 39,700 | 38,200 | 36,100 | 33,900 | 45,900 | 27,200 | 45,800 |   |   |
| Variable O&M, including electricity (€/MWh input)                        | 3.0    | 3.1    | 3.9    | 4.3    | 2.7    | 3.3    | 3.8    | 4.7    | M |   |
| Fuel storage specific cost in excess of 2 days (M€/MW_input/storage day) | 0.015  | 0.015  | 0.014  | 0.013  | 0.013  | 0.017  | 0.010  | 0.017  | L |   |
| Additional heat potential with heat pumps (% of thermal input)           | 1.9    | 1.9    | 1.9    | 1.9    | 1      | 26     | 1      | 28     | D | 1 |

**Notes:**

- A The plant is directly producing hot water for District Heating by burning fuel on a grate. Fluid-bed combustion technology may be an alternative. It can be assumed that the data for this does not differ significantly from grate fired boilers. Data in this sheet is applicable for plants in the range of 80-99,9 MW fired capacity (heat input).  
  
The plant is directly producing hot water for District Heating by burning fuel on a grate. Fluid-bed combustion technology may be an alternative. It can be assumed that the data for this does not differ significantly from grate fired boilers. Data in this sheet is applicable for plants in the range of 80-99,9 MW fired capacity (heat input).
- B Boilers larger than approx. 20 MW fuel input for hot water production are designed-for-purpose products with a high degree of fuel flexibility (type of biomass, humidity etc.)
- C Efficiencies refer to lower heating value. The stated total efficiency does NOT consider auxiliary electricity consumption. It describes the total net amount of heat produced at the plant. This is contrary to CHP where the auxiliary electricity is subtracted from the production to yield the net electricity efficiency.  
  
Direct condensation and combustion air humidification are included in all cases except in lower range of 2020 and 2050. The colder the return temperature of the district heating, the higher the total efficiency at direct condensation.
- D Additional heat potential for heat pump is the flue gas condensation potential remaining after the direct condensation stage (condensation by heat exchange with DH-water). Direct condensation and combustion air humidification are included in all cases except in lower/upper range of 2020 and 2050.
- E Load control of the heat production is important and units of this size can make rapid load variations.
- F Reference to heat output because of the lack of electricity production
- G assuming content of sulphur in fuel of 20 g/GJ
- H Warm start is starting with a glowing fuel layer on the grate.
- I
- J
- K Result of model calculation, there are reports of DH plants operating at lower power consumption, down to 1% of heat generation.
- L Note that investments include only two days fuel storage, and more may be optimal, depending on fuel supply opportunities and heat supply obligations, amongst other things.  
The additional investment is listed in the bottom row.
- M Variable O&M cost includes consumables (for FGT etc.), disposal of residues, small share of staff-cost and maintenance cost. Electricity consumption is included for DH and associated cost listed separately, in addition. Cost for disposal of recovered flue gas condensate is included at a rate of 1.0 €/tonne of condensate. Revenues from sale of heat are not included. Taxes are not included. The cost of auxiliary electricity consumption is calculated using the following electricity prices in €/MWh: 2015: 63, 2020: 69, 2030: 101, 2050: 117. These prices include production costs and transport tariffs, but not any taxes or subsidies for renewable energy.

**References:**

- 1 Rambøll Danmark, internal evaluation based on either existing projects, supplier and operator information, or pre-project studies.

- 2 Estimated from emission factors of 2006: 81 g/GJ NO<sub>x</sub>, 1.9 g/GJ for SO<sub>2</sub>, <1 g/GJ for CH<sub>4</sub>, 0.8 g/GJ for N<sub>2</sub>O, 10 g/GJ for Particles; cf. Nielsen, M., Nielsen, O.-K. & Thomsen, M. 2010: Emissions from decentralised CHP plants 2007 - Energinet.dk Environmental project no. 07/1882. Project report 5 – Emission factors and emission inventory for decentralised CHP production. National Environmental Research Institute, Aarhus University. 113 pp. – NERI Technical report No. 786. <http://www.dmu.dk/Pub/FR786.pdf>.



## Data sheets Wood Pellets, HOP

| Technology  | Wood Pellets, DH only, 6 MW feed |        |        |        |                    |                    |        |        |      |   |
|---|----------------------------------|--------|--------|--------|--------------------|--------------------|--------|--------|------|---|
|   | 2015                             | 2020   | 2030   | 2050   | Uncertainty (2020) | Uncertainty (2050) | Note   | Ref    |      |   |
| <b>Energy/technical data</b>                      |                                  |        |        |        | Lower              | Upper              | Lower  | Upper  |      |   |
| Heat generation capacity for one unit (MW)        | 6.1                              | 6.1    | 6.1    | 6.1    | 5.4                | 6.1                | 5.4    | 6.1    | A    | 1 |
| Total efficiency, net (%), name plate             | 101.4                            | 101.4  | 101.4  | 101.4  | 90                 | 102                | 89     | 102    | B,C  | 1 |
| Total efficiency, net (%), annual average         | 101.4                            | 101.4  | 101.4  | 101.4  | 90                 | 102                | 89     | 102    | B,C  | 1 |
| Auxiliary electricity consumption (% of heat gen) | 2.1                              | 2.1    | 2.1    | 2.1    | 1.7                | 2.3                | 1.4    | 2.3    | C,K  |   |
| Forced outage (%)                                 | 3.0                              | 3.0    | 3.0    | 3.0    | 3.0                | 3.0                | 3.0    | 3.0    |      |   |
| Planned outage (weeks per year)                   | 3.0                              | 3.0    | 3.0    | 3.0    | 2.6                | 3.5                | 2.3    | 3.8    |      |   |
| Technical lifetime (years)                        | 25.0                             | 25.0   | 25.0   | 25.0   | 20.0               | 35.0               | 20.0   | 35.0   |      | 1 |
| Construction time (years)                         | 1.0                              | 1.0    | 1.0    | 1.0    | 0.5                | 1.5                | 0.5    | 1.5    |      | 1 |
| Space requirement (1000 m2/MWth heat output)      | 0.2                              | 0.2    | 0.2    | 0.2    | 0.1                | 0.2                | 0.1    | 0.2    |      |   |
| <b>Regulation ability</b>                         |                                  |        |        |        |                    |                    |        |        |      |   |
| Primary regulation (% per 30 seconds)             | NA                               | NA     | NA     | NA     | NA                 | NA                 | NA     | NA     |      |   |
| Secondary regulation (% per minute)               | 10.0                             | 10.0   | 10.0   | 10.0   | 10.0               | 10.0               | 10.0   | 10.0   | E    | 1 |
| Minimum load (% of full load)                     | 40.0                             | 40.0   | 40.0   | 40.0   | 40.0               | 40.0               | 40.0   | 40.0   | E    | 1 |
| Warm start-up time (hours)                        | 0.3                              | 0.3    | 0.3    | 0.3    | 0.3                | 0.3                | 0.3    | 0.3    | H    | 1 |
| Cold start-up time (hours)                        | 0.5                              | 0.5    | 0.5    | 0.5    | 0.5                | 0.5                | 0.5    | 0.5    |      | 1 |
| <b>Environment</b>                                |                                  |        |        |        |                    |                    |        |        |      |   |
| SO <sub>2</sub> (degree of desulphuring, %)       | 98.3                             | 98.3   | 98.3   | 98.3   | 91.3               | 99.1               | 98.3   | 99.1   | G    | 1 |
| NO <sub>x</sub> (g per GJ fuel)                   | 90                               | 50     | 40     | 40     | 40                 | 70                 | 20     | 40     | G    | 1 |
| CH <sub>4</sub> (g per GJ fuel)                   | 0                                | 0      | 0      | 0      | 0                  | 0                  | 0      | 0      | G    | 1 |
| N <sub>2</sub> O (g per GJ fuel)                  | 1                                | 1      | 1      | 1      | 1                  | 3                  | 0      | 1      | G    | 1 |
| Particles (g per GJ fuel)                         | 2.0                              | 0.3    | 0.3    | 0.3    | 0.1                | 2.0                | 0.1    | 1.0    | G    | 1 |
| <b>Financial data</b>                             |                                  |        |        |        |                    |                    |        |        |      |   |
| Nominal investment (M€/MWth - heat output)        | 0.73                             | 0.71   | 0.68   | 0.61   | 0.62               | 0.84               | 0.51   | 0.90   | F, L |   |
| - of which equipment                              | 0.44                             | 0.43   | 0.41   | 0.37   | 0.38               | 0.51               | 0.31   | 0.56   | F, L |   |
| - of which installation                           | 0.29                             | 0.28   | 0.27   | 0.24   | 0.24               | 0.33               | 0.20   | 0.33   | F, L |   |
| Fixed O&M (€/MWth/year), heat output              | 33,500                           | 32,600 | 30,900 | 27,900 | 27,900             | 37,800             | 21,600 | 37,000 | F    |   |
| Variable O&M (€/MWh) heat output                  | 1.86                             | 1.98   | 2.64   | 2.97   | 1.83               | 2.33               | 2.76   | 3.57   | F, M |   |
| - of which is electricity costs (€/MWh-heat)      | 1.30                             | 1.42   | 2.08   | 2.41   | 1.41               | 1.62               | 2.38   | 2.79   | F, M |   |
| - of which is other O&M costs (€/MWh-heat)        | 0.56                             | 0.56   | 0.56   | 0.56   | 0.43               | 0.71               | 0.38   | 0.78   | F, M |   |
| <b>Technology specific data</b>                   |                                  |        |        |        |                    |                    |        |        |      |   |
| Flue gas condensation                             | Yes                              | Yes    | Yes    | Yes    | No                 | Yes                | No     | Yes    | D,J  |   |
| Combustion air humidification                     | Yes                              | Yes    | Yes    | Yes    | No                 | Yes                | No     | Yes    | D,J  |   |
| Output of recovered condensate (tonne/MWh_input)  | 0.06                             | 0.06   | 0.06   | 0.06   | 0.00               | 0.06               | 0.00   | 0.06   | D    |   |
| Nominal investment (M€/MW fuel input)             | 0.74                             | 0.72   | 0.69   | 0.62   | 0.63               | 0.85               | 0.52   | 0.91   | J, L | 1 |
| - of which equipment                              | 0.45                             | 0.44   | 0.42   | 0.38   | 0.38               | 0.52               | 0.31   | 0.57   | L    |   |
| - of which installation                           | 0.29                             | 0.28   | 0.27   | 0.24   | 0.25               | 0.34               | 0.20   | 0.34   | L    |   |

|  |        |        |        |        |        |        |        |        |   |   |
|--|--------|--------|--------|--------|--------|--------|--------|--------|---|---|
| Fixed O&M (€/MW input/year)  | 34,000 | 33,100 | 31,300 | 28,300 | 28,300 | 38,300 | 21,900 | 37,500 |   |   |
| Variable O&M, including electricity (€/MWh input)                        | 1.89   | 2.01   | 2.68   | 3.02   | 1.86   | 2.12   | 2.81   | 3.19   | M |   |
| Fuel storage specific cost in excess of 2 days (M€/MW_input/storage day) | 0.004  | 0.004  | 0.004  | 0.003  | 0.003  | 0.005  | 0.003  | 0.005  | L |   |
| Additional heat potential with heat pumps (% of thermal input)           | 1.7    | 1.7    | 1.7    | 1.7    | 1      | 12     | 1      | 13     | D | 1 |

**Notes:**

- A The plant is directly producing hot water for District Heating by burning fuel on a grate.  
The system is optimised at DH return temperature 40°C and flow 80°C.
- B Boilers up to 20 MW fuel input for hot water production are more or less standardized products with a high degree of fuel flexibility (type of biomass, humidity etc.)
- C The stated total efficiency does NOT consider auxiliary electricity consumption. It describes the total net amount of heat produced at the plant. This is contrary to CHP where the auxiliary electricity is subtracted from the production to yield the net electricity efficiency.
- D Since wood pellets are relatively dry there is often only a minor efficiency advantage in using flue gas condensation. There is though an environmental advantage in having a scrubber in the flue gas stream. Direct condensation and combustion air humidification are included in all cases except in lower/upper range of 2020 and 2050.
- E Load control of the heat production is important and units of this size can make rapid load variations. Similarly, the minimum load is quite low
- F Reference to heat output because of the lack of electricity production
- G Emissions shall comply with the order of the Danish EPA no 1535 of 2019 (Bekendtgørelse om miljøkrav for mellemstore fyringsanlæg), implementing the Medium Combustion Directive, Directive (EU) 2015/2193 of the European Parliament and of the Council of 25 November 2015 on the limitation of emissions of certain pollutants into the air from medium combustion plants..  
It is anticipated that for the smaller units the supplier has an SNCR solution to reduce NOx emissions sufficiently. However, to reach NOx-levels below 40 g/GJ SCR is assumed.
- I Warm start is starting with a glowing fuel layer on the grate.
- J The nominal investment is in the range 0.6 to 1.1 M€/MWth
- K Result of model calculation, there are reports of DH plants operating at lower power consumption
- L Note that investments include only two days fuel storage, and more may be optimal, depending on fuel supply opportunities and heat supply obligations, amongst other things.  
The additional investment is listed in the bottom row.
- M Variable O&M cost includes consumables (for FGT etc.), disposal of residues, small share of staff-cost and maintenance cost. Electricity consumption is included for DH and associated cost listed separately, in addition. Cost for disposal of recovered flue gas condensate is included at a rate of 1.0 €/tonne of condensate. Revenues from sale of heat are not included. Taxes are not included. The cost of auxiliary electricity consumption is calculated using the following electricity prices in €/MWh: 2015: 63, 2020: 69, 2030: 101, 2050: 117. These prices include production costs and transport tariffs, but not any taxes or subsidies for renewable energy.

**References:**

- 1 Rambøll Danmark, internal evaluation based on either existing projects, supplier offers, or pre-project studies.

## Data sheets Straw, HOP

| Technology  | Small Straw, DH only, 6 MW feed |        |        |        |                    |                    |        |        | Note | Ref |
|---|---------------------------------|--------|--------|--------|--------------------|--------------------|--------|--------|------|-----|
|   | 2015                            | 2020   | 2030   | 2050   | Uncertainty (2020) | Uncertainty (2050) |        |        |      |     |
| <b>Energy/technical data</b>                      |                                 |        |        |        | Lower              | Upper              | Lower  | Upper  |      |     |
| Heat generation capacity for one unit (MW)        | 6.2                             | 6.2    | 6.2    | 6.2    | 5.3                | 6.2                | 5.3    | 6.2    | A    | 1   |
| Total efficiency, net (%), name plate             | 103.2                           | 103.2  | 103.2  | 103.2  | 88                 | 104                | 88     | 104    | B,C  | 1   |
| Total efficiency, net (%), annual average         | 103.2                           | 103.2  | 103.2  | 3.0    | 88                 | 104                | 88     | 104    | B,C  | 1   |
| Auxiliary electricity consumption (% of heat gen) | 2.1                             | 2.1    | 2.1    | 2.1    | 1.8                | 2.3                | 1.4    | 2.3    | C,J  |     |
| Forced outage (%)                                 | 4.0                             | 4.0    | 4.0    | 4.0    | 4.0                | 4.0                | 4.0    | 4.0    |      |     |
| Planned outage (weeks per year)                   | 4.0                             | 4.0    | 4.0    | 4.0    | 3.4                | 4.6                | 3.0    | 5.0    |      |     |
| Technical lifetime (years)                        | 25.0                            | 25.0   | 25.0   | 25.0   | 20.0               | 35.0               | 20.0   | 35.0   |      | 1   |
| Construction time (years)                         | 1.0                             | 1.0    | 1.0    | 1.0    | 0.5                | 1.5                | 0.5    | 1.5    |      | 1   |
| Space requirement (1000 m <sup>2</sup> /MWe)      | 0.2                             | 0.2    | 0.2    | 0.2    | 0.2                | 0.3                | 0.2    | 0.3    |      |     |
| <b>Regulation ability</b>                         |                                 |        |        |        |                    |                    |        |        |      |     |
| Primary regulation (% per 30 seconds)             | NA                              | NA     | NA     | NA     | NA                 | NA                 | NA     | NA     |      |     |
| Secondary regulation (% per minute)               | 10.0                            | 10.0   | 10.0   | 10.0   | 10.0               | 10.0               | 10.0   | 10.0   | E    | 1   |
| Minimum load (% of full load)                     | 50.0                            | 50.0   | 50.0   | 50.0   | 50.0               | 50.0               | 50.0   | 50.0   | E    | 1   |
| Warm start-up time (hours)                        | 0.3                             | 0.3    | 0.3    | 0.3    | 0.3                | 0.3                | 0.3    | 0.3    | H    | 1   |
| Cold start-up time (hours)                        | 0.5                             | 0.5    | 0.5    | 0.5    | 0.5                | 0.5                | 0.5    | 0.5    |      | 1   |
| <b>Environment</b>                                |                                 |        |        |        |                    |                    |        |        |      |     |
| SO <sub>2</sub> (degree of desulphuring, %)       | 95.5                            | 96.4   | 99.1   | 99.8   | 90.9               | 99.8               | 95.5   | 99.9   | G    | 1   |
| NO <sub>x</sub> (g per GJ fuel)                   | 90                              | 70     | 70     | 70     | 40                 | 90                 | 20     | 70     | G    | 1   |
| CH <sub>4</sub> (g per GJ fuel)                   | 16                              | 11     | 8      | 4      | 4                  | 16                 | 2      | 16     | G    | 1   |
| N <sub>2</sub> O (g per GJ fuel)                  | 4                               | 3      | 2      | 1      | 1                  | 4                  | 1      | 4      | G    | 1   |
| Particles (g per GJ fuel)                         | 2.0                             | 0.3    | 0.3    | 0.3    | 0.1                | 2.0                | 0.1    | 1.0    | G    | 1   |
| <b>Financial data</b>                             |                                 |        |        |        |                    |                    |        |        |      |     |
| Nominal investment (M€/MWth - heat output)        | 0.90                            | 0.88   | 0.83   | 0.75   | 0.76               | 1.08               | 0.62   | 1.09   | F,K  |     |
| - of which equipment                              | 0.44                            | 0.43   | 0.40   | 0.37   | 0.37               | 0.55               | 0.30   | 0.55   | F,K  |     |
| - of which installation                           | 0.46                            | 0.45   | 0.43   | 0.39   | 0.39               | 0.53               | 0.32   | 0.54   | F,K  |     |
| Fixed O&M (€/MWth/year), heat output              | 52,300                          | 50,800 | 47,900 | 42,900 | 43,400             | 59,600             | 32,800 | 55,700 | F    |     |
| Variable O&M (€/MWh) heat output                  | 1.99                            | 2.11   | 2.78   | 3.12   | 1.92               | 2.59               | 2.86   | 3.84   | F, M |     |
| - of which is electricity costs (€/MWh-heat)      | 1.32                            | 1.45   | 2.12   | 2.45   | 1.43               | 1.71               | 2.42   | 2.90   | F, M |     |
| - of which is other O&M costs (€/MWh-heat)        | 0.67                            | 0.67   | 0.67   | 0.67   | 0.49               | 0.88               | 0.43   | 0.94   | F, M |     |
| <b>Technology specific data</b>                   |                                 |        |        |        |                    |                    |        |        |      |     |
| Flue gas condensation                             | Yes                             | Yes    | Yes    | Yes    | No                 | Yes                | No     | Yes    | D    |     |
| Combustion air humidification                     | Yes                             | Yes    | Yes    | Yes    | No                 | Yes                | No     | Yes    | D    |     |
| Output of recovered condensate (tonne/MWh_input)  | 0.09                            | 0.09   | 0.09   | 0.09   | 0.00               | 0.09               | 0.00   | 0.09   | D, M |     |
| Nominal investment (M€/MW fuel input)             | 0.93                            | 0.90   | 0.86   | 0.78   | 0.79               | 1.12               | 0.64   | 1.12   | I,K  | 1   |
| - of which equipment                              | 0.45                            | 0.44   | 0.42   | 0.38   | 0.38               | 0.57               | 0.31   | 0.57   | K    |     |
| - of which installation                           | 0.48                            | 0.46   | 0.44   | 0.40   | 0.41               | 0.55               | 0.33   | 0.55   | K    |     |

|  |        |        |        |        |        |        |        |        |   |   |
|--|--------|--------|--------|--------|--------|--------|--------|--------|---|---|
| Fixed O&M (€/MW input/year)  | 54,000 | 52,400 | 49,400 | 44,200 | 44,800 | 61,600 | 33,900 | 57,500 |   |   |
| Variable O&M, including electricity (€/MWh input)                        | 2.05   | 2.18   | 2.87   | 3.22   | 1.99   | 2.30   | 2.96   | 3.42   | M |   |
| Fuel storage specific cost in excess of 2 days (M€/MW_input/storage day) | 0.080  | 0.078  | 0.074  | 0.067  | 0.068  | 0.092  | 0.056  | 0.093  | K |   |
| Additional heat potential with heat pumps (% of thermal input)           | 1.8    | 1.8    | 1.8    | 1.8    | 1      | 15     | 1      | 15     | D | 1 |

**Notes:**

- A The plant is directly producing hot water for District Heating by burning fuel on a grate.
- B Boilers up to 20 MW fuel input for hot water production are more or less standardized products with a high degree of fuel flexibility (type of biomass, humidity etc.)
- C The stated total efficiency does NOT consider auxiliary electricity consumption. It describes the total net amount of heat produced at the plant. This is contrary to CHP where the auxiliary electricity is subtracted from the production to yield the net electricity efficiency.
- D Since straw is relatively dry there is often only a minor efficiency advantage in using flue gas condensation. There is though an environmental advantage in having a scrubber in the flue gas stream. Direct condensation and combustion air humidification are included in all cases except in lower/upper range of 2020 and 2050.  
The system is optimised at DH return temperature 40°C and flow 80°C.
- E Load control of the heat production is important and units of this size can make rapid load variations. Similarly, the minimum load is quite low
- F Reference to heat output because of the lack of electricity production
- G Emissions shall comply with the order of the Danish EPA no 1535 of 2019 (Bekendtgørelse om miljøkrav for mellemstore fyringsanlæg), implementing the Medium Combustion Directive, Directive (EU) 2015/2193 of the European Parliament and of the Council of 25 November 2015 on the limitation of emissions of certain pollutants into the air from medium combustion plants..  
It is anticipated that for the smaller units the supplier has an SNCR solution to reduce NOx emissions sufficiently. However, to reach NOx-levels below 40 g/GJ SCR is assumed.  
Warm start is starting with a glowing fuel layer on the grate.
- I The nominal investment is in the range 0.6 to 1.1 M€/MWth
- J Result of model calculation, there are reports of DH plants operating at lower power consumption
- K Note that investments include only two days fuel storage, and more may be optimal, depending on fuel supply opportunities and heat supply obligations, amongst other things.  
The additional investment is listed in the bottom row.
- L
- M Variable O&M cost includes consumables (for FGT etc.), disposal of residues, small share of staff-cost and maintenance cost. Electricity consumption is included for DH and associated cost listed separately, in addition. Cost for disposal of recovered flue gas condensate is included at a rate of 1.0 €/tonne of condensate. Revenues from sale of heat are not included. Taxes are not included. The cost of auxiliary electricity consumption is calculated using the following electricity prices in €/MWh: 2015: 63, 2020: 69, 2030: 101, 2050: 117. These prices include production costs and transport tariffs, but not any taxes or subsidies for renewable energy.

**References:**

- 1 Rambøll Danmark, internal evaluation based on either existing projects, supplier offers, or pre-project studies.

## 10 Stirling engines, gasified biomass

This chapter has been moved here from the previous Technology Data Catalogue for Electricity and district heating production from May 2012. Therefore, the text and data sheets do not follow the same guidelines as the remainder of the catalogue.

### Brief technology description

A Stirling engine is driven by temperature differences created by external heating and cooling sources. One part of the engine is permanently hot, while another part of the engine is permanently cold.

The engine is filled with a working gas, typically Hydrogen or Helium, and pressurized. This working gas is moved between the hot and the cold side of the engine by a mechanical system comprising of a displacement piston coupled to a working piston. When the working gas is heated in the hot side of the engine, it expands and pushes the working piston. When the working piston moves, the displacement piston then forces the working gas to the cold side of the engine, where it cools and contracts.

In the biomass-gasifier solution developed by the company Stirling DK, the engine is Helium-filled, heated by biomass combustion flue gasses, and cooled by cooling water.

Specifically, a solid biomass fuel is converted into producer gas, which is led to one or more combustion chambers, each coupled to a Stirling engine. The gas is ignited in the combustion chamber(s), and the flue gases are heating the Stirling engine(s), which is driving an electricity generator.

For a more detailed description of the gasifier process, please refer to technology no. 84.

### Input

Wood chips, industrial wood residues, demolition wood and energy crops can be used. Also, it is expected that more exotic fuel types, such as coconut shells and olive stones, can be used. Requirements to moisture content and size of the fuel are depending on the design of the gasifier.

The Stirling engines can also be fuelled by natural gas and mineral oil.

### Output

Electricity and heat.

The electricity efficiency, when using wood chips, is around 18%.

### Typical capacities

The electric output of one Stirling engine is 35 kW. For plants with several engines, one common gasifier is used.

### Regulation ability

The heat load can be changed from 10 to 100 % and vice versa within a few minutes. The electrical output can not be regulated quickly.

### Advantages/disadvantages

The main advantage of the Stirling engine is that it can generate power using residues from forestry and agriculture, which typically have a very low economic value. In addition, emission levels are very low. Finally, the service requirement of a Stirling engine is very low compared to otto- and diesel-engines.

The main disadvantage is a relatively high capital cost compared to otto- and diesel-engines.

Stirling engines are therefore ideally used for base load generation with many annual operating hours, preferable 6-8,000 hours/year.

## Environment

A highly controlled gasification process together with the continuous combustion process secure much lower air emissions than otto- and diesel-engines.

## Research, development and demonstration

The Danish Stirling engine updraft-gasifier technology is presently being supported in two projects:

- A multi-unit system with two engines and a wood gas boiler (for heat only) on one common updraft gasifier, is being developed, supported by PSO-means. Also a new combustion technology, high efficiency, is being developed under this program.
- A containerized plant has been built, supported by EUDP-means. In order to demonstrate fuel flexibility, the plant will be tested with 8 different fuel types. Also, an off-grid solution will be developed.

## Examples of best available technology

Examples of plants in Denmark:

- In Svanholm, an 800 kJ/s updraft counter-current fixed bed gasifier was installed in 2009. The gasifier utilises wood chips and is coupled to two 35 kW Stirling engines and a 400 kJ/s wood gas boiler.
- In both Copenhagen and Lyngby, a 200 kJ/s updraft counter-current fixed bed gasifier was installed in 2009. Each gasifier utilises wood chips and is coupled to one 35 kW Stirling engine

## References

1. Biomasse kraftvarme udviklingskortlægning – Resume-rapport. Eltra. Elkraft System. Danish Energy Agency, 2003
2. Strategi for forskning, udvikling og demonstration af biomasseteknologi til el- og kraftvarmeproduktion i Danmark, Danish Energy Agency, Elkraft System og Eltra, 2003.
3. Stirling DK, December 2009.

## Data sheets

| Technology                                  | Stirling engine, fired by gasified biomass |       |      |      |      |     |
|---|--|-------|------|------|------|-----|
|   | 2015                                       | 2020  | 2030 | 2050 | Note | Ref |
| <b>Energy/technical data</b>                |  |       |      |      |      |     |
| Generating capacity electric, (kW)          | 37   | 40    |      |      |      | 1   |
| Generating capacity, heat, (kJ/s)           | 120  | 120   |      |      |      | 1   |
| Electrical efficiency (%)                   | 20   | 22    |      |      | A    | 1   |
| Time for warm-up (hours)                    | 1  | 1     |      |      |      | 1   |
| Forces outage (%)                           | 4  | 3     |      |      |      | 1   |
| Planned outage (weeks per year)             | 3  | 2     |      |      |      | 1   |
| Technical lifetime (years)                  | 15   | 15    |      |      |      | 1   |
| Construction time (years)                   | 0  | 0.3   |      |      | B    | 1   |
| <b>Environment</b>                          |  |       |      |      |      |     |
| SO <sub>2</sub> (degree of desulphuring, %) | 0  | 0     |      |      |      | 1   |
| NO <sub>x</sub> (ppm)                       | 130  | 100   |      |      |      | 1   |
| CH <sub>4</sub> (ppm)                       | 0  | 0     |      |      |      | 1   |
| N <sub>2</sub> O (ppm)                      | 0  | 0     |      |      |      | 1   |
| <b>Financial data</b>                       |  |       |      |      |      |     |
| Specific investment costs (M€/MW)           | 5.0  | 3.8   |      |      | C+E  | 1   |
| Fixed O&M (€/MW/year)                       | 32000                                      | 32000 |      |      | D+E  | 1   |
| Variable O&M (€/MWh)                        | 26   | 21    |      |      | D+E  | 1   |

**References:**

- 1 Stirling DK, December 2009

**Notes:**

- A The efficiency of the gasifier is 97%, while the total efficiency for the whole system is 90% (2020).
- B The plants may be delivered as pre-assembled container solutions reducing construction times on site to a couple of weeks.
- C Complete plant, including gasifier, combustion chambers, engines, control system, piping, and instrumentation.
- D O&M for the Stirling engine itself is (2010) around 16 €/MWh, while the remaining O&M costs are for biomass feeding, gasification, heat exchangers etc.
- E Cost data are the same as in the 2010 catalogue, however inflated from price level 2008 to 2011 by multiplying with a general inflation factor 1.053

## 11 Solid oxide fuel cell CHP (natural gas/biogas)

### Contact information:

Danish Energy Agency: Rikke Næraa, [rin@ens.dk](mailto:rin@ens.dk)

Energinet: Rune Grandal, [rdg@energinet.dk](mailto:rdg@energinet.dk)

Author: DTU Energy, Jonathan Hallinder, Eva Ravn Nielsen in cooperation with Ea Energy Analyses.

Adapted from “Technology Data for Hydrogen Technologies” (2016), prepared as part of the project “Analysis for Commercialization of Hydrogen Technologies” under the Danish Energy Technology Development and Demonstration Programme (EUDP).

Review: DGC

### Publication date

March 2018

### Amendments after publication date

| Date | Ref. | Description |
|------|------|-------------|
| -    | -    | -           |
| -    | -    | -           |

## Qualitative description

### Brief technology description

Solid oxide fuel cell based combined heat and power systems (SOFC-CHP), or SOFC Distributed Generation, typically use natural gas or biogas as fuel and, therefore, they can simply be connected to the gas grid like conventional natural gas boilers. Alternatively, SOFC-CHP can also utilise hydrogen and syngas or propane/LPG or diesel as fuel. A CHP system produces both electricity and heat. The electricity can be used directly at the production site, be fed into the electrical grid or in remote areas be the sole source of electricity substituting a diesel generator. The produced heat can either be used directly at the site or delivered to a district heating grid.

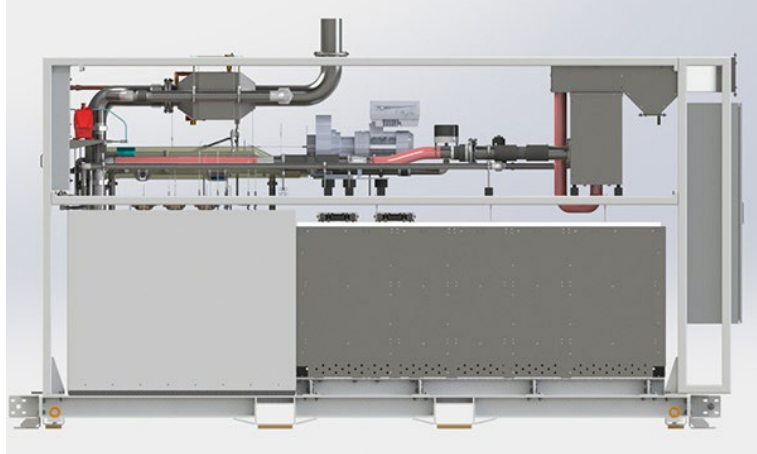

Figure 1: SOFC unit from Sunfire for combined heat and power for commercial use [9].



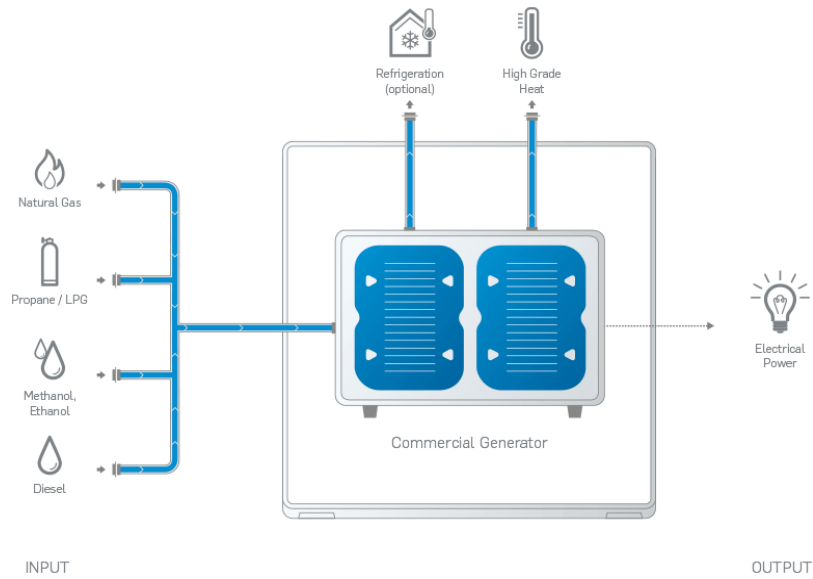

Figure 2: Schematic illustration of an SOFC unit for combined heat and power for commercial use from Sunfire illustrating the flexibility in input fuels [9].



Figure 3: C50 module from Convion with 50 kW. Systems up to 300 kW are being developed [10].

### Input

Natural gas or biogas.

### Output

Electricity and heat.

The product can be designed to meet the requirements for district heating, but the present early products focus mainly on providing power. The fuel cell is operated at very high temperatures (600-700 degree Celsius) allowing the surplus heat to be used for high temperature industrial processes.

In the data sheet CHP systems are only considered from 2020.

With minor adaption to the feeding system a SOFC unit may also be fuelled with ethanol and ammonia.

### Typical capacities

Today, no large scale SOFC-CHP systems are available at the market, but they can be aligned with the sizes of pure distributed generation units used for baseload and backup, e.g. SOFC systems like systems provided by Bloom energy. These systems are today available in modules up to 250 kW<sub>e</sub> power, but as mentioned above these modules can be clustered to achieve larger plants [1].

SOFC-CHP systems are also available in very small scale including mCHP plants for households.

### Space requirement

23 m<sup>2</sup>/MW<sub>e</sub> (based on one Energy Server 5 + five UPM-571 modules from Bloom Energy [11] of 1.25 MW in total).

### Regulation ability

The fuel cell CHP system can modulate, but the high temperature of reformer and fuel cell requires the hot part to be kept at a high temperature to facilitate modulating.

SOFC systems can be designed to regulate below 30% of nominal load without any significant loss of efficiency. The response time can be very short (a few seconds) when the system is in standby mode.

### Advantages/disadvantages

The main advantages include:

- SOFC-CHP units produce both electricity and heat in cogeneration with higher electrical efficiency than for other cogeneration technologies in the same power range fuelled by natural gas or biogas.
- Decentralised cogeneration of electricity and heat minimises grid losses and the need for additional infrastructure investments.
- The required gas quality is less strict compared to gas engines. SOFC-CHP units are more flexible in relation to fuels and can run on different types of gasses (methane, syngas, hydrogen and biogas) without them being upgraded to SNG. This means that natural gas fuelled SOFC-CHP can be operated from the natural gas grid even if the natural gas is exchanged with synthetic natural gas (SNG).
- Unlike conventional power plants, the produced CO<sub>2</sub> is not mixed with oxygen and nitrogen from the atmosphere. This makes it easier and more cost-efficient to capture and store the produced CO<sub>2</sub>.

The main disadvantages include:

- Currently, lifetime of the stacks is relatively short. Some manufacturers do however report a stack life-time of about 6 years when operating in baseload. Several replacements of stacks may be relevant during the lifetime of the plant.
- Long start-up times from a cold start.

### Environment

The emissions from natural gas fuelled SOFCs are relatively low compared to electricity produced at central power plants. Because there is no combustion of fuels (it is a chemical reaction), the emission of for example  $\text{NO}_x$  is lower than what is emitted from a traditional power plant. If biogas (fossil free gas) is used the operation of the plant can be considered carbon neutral. Today, the most common used material for the anode in SOFCs consist of nickel mixed with yttria-stabilized zirconia (YSZ). In the production and end of life disposal, the use of nickel is a concern as it is carcinogenic.

### Research and development perspectives

SOFC-CHP units are still under development. The development is concentrated on reducing the costs of the units, increasing the lifetime and increasing the reliability.

In a later phase, the research and development activities may be concentrated on how to use the units in a smart grid context so that fuel cells can optimize their operation according to dynamic electricity prices.

BloomEnergy from USA is developing and has commercialized fuel cell systems for base load / backup power, meaning systems where only the power is used and the heat considered waste. Thus, they are not developing CHP systems they are the only player on the commercial market with SOFC systems in the adequate power range. A few other companies are getting close to realizing their first commercial SOFC CHP units, for example Mitsubishi ([1], [2]), Sunfire and Convion.



Figure 4: BloomEnergy SOFC system. The dashed region corresponds to the 250 kW<sub>e</sub> unit [1].

### Examples of market standard technology

Large scale SOFC units for power supply can be purchased from BloomEnergy, Convion and Sunfire. The first two focus on providing power, whereas the latter focus on a reversible system that can alternate between providing power and providing hydrogen (SOFC/SOEC).

No CHP systems in the relevant power range are available; therefore, the Bloom Energy ES-5710 unit has been selected as the reference system. This system is a power producing system and does not utilise the produced heat.

### Prediction of performance and costs

The technology is classified between Category 1: Research and development and Category 2: Pioneer phase, demonstration.

The typical generation capacity is expected to increase from around 2.5 MW in 2020 to around 20 MW in 2050, while the electrical efficiency is expected to increase to 60%. The investment costs of the SOFC CHP are projected to decrease from 3.3 M€<sub>2015</sub>/MW in 2020 to 0.6 M€<sub>2015</sub>/MW in 2050. The projection is based on Cost Study for Manufacturing of Solid Oxide Fuel Cell Power Systems, 2013, Pacific Northwest National Laboratory prepared for the U.S. Department of Energy [13]. In 2020, an annual production of 50 units is assumed, in 2030 a yearly production of 250 units is assumed, and in 2050, a production of 4000 units per year is assumed.

For comparison the Technology Roadmap - Hydrogen and Fuel Cells, 2015, International Energy Agency [12], estimates a cost reduction to around 1.8 M€<sub>2015</sub>/MW between 2025 and 2035.

**Uncertainty**

The uncertainty related to the cost projection is very significant and is affected by challenges such as lifetime improvements, improved operational flexibility and reduction of investment costs as a result of mass production.

**Economy of scale**

-

**Additional remarks**

No additional remarks.

Data sheets

| Technology  | SOFC - CHP Natural Gas / Biogas |         |         |        |                    |         |                    |        | Note       | Reference  |
|---|---------------------------------|---------|---------|--------|--------------------|---------|--------------------|--------|------------|------------|
|   | 2015                            | 2020    | 2030    | 2050   | Uncertainty (2020) |         | Uncertainty (2050) |        |            |            |
| <b>Energy/technical data</b>  |                                 |         |         |        |                    |         |                    |        |            |            |
|   |                                 |         |         |        | Lower              | Upper   | Lower              | Upper  |            |            |
| Generating capacity for one unit (MWe)  | 0.25                            | 2.5     | 10      | 20     |                    |         |                    |        | A          | 3; *, *, * |
| Electricity efficiency (condensation mode for extraction plants), net (%), name plate     | 56                              | 58      | 60      | 60     |                    |         |                    |        |            |            |
| Electricity efficiency (condensation mode for extraction plants), net (%), annual average | 56                              | 58      | 60      | 60     | 52                 | 60      | 56                 | 62     | B          | 3; *, *, * |
| Cb coefficient (50°C/100°C)   | -                               | 1.67    | 1.61    | 1.61   |                    |         |                    |        | C, L       | -, *, *, * |
| Cv coefficient (50°C/100°C)   | -                               | -       | -       | -      |                    |         |                    |        |            |            |
| Forced outage (%)   |                                 |         |         |        |                    |         |                    |        |            |            |
| Planned outage (weeks per year)   |                                 |         |         |        |                    |         |                    |        |            |            |
| Technical lifetime (years)  | 15                              | 20      | 20      | 20     |                    |         |                    |        | D          | 6; 6; *, * |
| Construction time (years)   | 1                               | 1       | 1       | 1      |                    |         |                    |        |            |            |
|   |                                 |         |         |        |                    |         |                    |        |            |            |
| <b>Regulation ability</b>   |                                 |         |         |        |                    |         |                    |        |            |            |
| Primary regulation (% per 30 seconds)   |                                 |         |         |        |                    |         |                    |        |            |            |
| Secondary regulation (% per minute)   |                                 |         |         |        |                    |         |                    |        |            |            |
| Minimum load (% of full load)   | 70                              | 70      | 70      | 70     |                    |         |                    |        |            |            |
| Warm start-up time (hours)  | 0.025                           | 0.025   | 0.025   | 0.025  |                    |         |                    |        | E          |            |
| Cold start-up time (hours)  | 25                              | 25      | 25      | 25     |                    |         |                    |        | E          | *, *, *, * |
|   |                                 |         |         |        |                    |         |                    |        |            |            |
| <b>Environment</b>  |                                 |         |         |        |                    |         |                    |        |            |            |
| SO <sub>2</sub> (degree of desulphuring, %)   | 100                             | 100     | 100     | 100    |                    |         |                    |        |            | 3          |
| NO <sub>x</sub> (g per GJ fuel)   | 1.3                             | 1.4     | 1.5     | 1.6    |                    |         |                    |        |            | 3          |
| CH <sub>4</sub> (g per GJ fuel)   | 1.25                            | 1.25    | 1.25    | 1.25   |                    |         |                    |        | F          | 7          |
| N <sub>2</sub> O (g per GJ fuel)  | NA                              | NA      | NA      | NA     |                    |         |                    |        | F          | *          |
|   |                                 |         |         |        |                    |         |                    |        |            |            |
| <b>Financial data</b>   |                                 |         |         |        |                    |         |                    |        |            |            |
| Nominal investment (M€/MW)  | 8.3                             | 3.3     | 2       | 0.8    | 2.7                | 5.8     | 0.4                | 1.3    | G, H, I, J | 8, 13      |
| - of which equipment  | 6.64                            | 2.3     | 1.2     | 0.464  |                    |         |                    |        | G          |            |
| - of which installation   | 1.66                            | 1.0     | 0.8     | 0.336  |                    |         |                    |        | G          |            |
| Fixed O&M (€/MW/year)   | 415,000                         | 165,000 | 100,000 | 40,000 | 135,000            | 290,000 | 20,000             | 65,000 | K          | 8          |
| Variable O&M (€/MWh)  | -                               |         |         |        |                    |         |                    |        |            |            |
| Startup cost (€/MW/startup)   | -                               |         |         |        |                    |         |                    |        |            |            |

### Notes:

- A Installed systems consist of modules of app. 200 kWel power, these modules can be clustered into larger units. Today, often up to app. 2 MWel power and upwards. [5,8]
- B The electrical efficiency (based on the lower heating value, LHV) of Bloom Energy's systems decreases from an initial value of 60 % to 52 % by the end-of life for the stacks. This gives an average electrical efficiency of 56 % for the life-time of a stack. Uncertainties represent the aforementioned interval.
- C No CHP-systems in this power range are available, therefore, Bloom Energy ES-5710 unit has been chosen as the reference system. This system is a power producing system and does not take the produced heat into account. . The produced heat can be used as thermal storage, hot water production, heating or for feed in to the distributed heating system. High total efficiencies can be expected as the systems are compact and with a small surface area, leading to low heat losses and thereby high total system efficiency. Thus it is not unrealistic to assume a total efficiency above 90 % (thermal efficiency > 35 %) for this type of system.
- D Values correspond to the durability for the whole plant; the stack may be exchanged several times during the life time of the plant.
- E Start up from outdoor temperature or room temperature takes rather long time, this is mainly due to the large amount of ceramic material which require slow heating ramps. If the system is at operating temperature the stack can be started up quickly, assuming that gases are supplied and help systems are active. Also shut down can be performed quickly, not counting in the time required to cool the system.
- F Value for SOFC microCHP systems used here, since SOFC-CHP's has the same operating principle.
- G A bloom unit costs approximately 6600 euro per kWel. To this must the installation costs be added, which of course depends on the location and the size of the unit. Additional costs are also to cover for necessary modifications of the system, e.g. implementation of hot water storage and subsystems for exporting the heat from the unit to surrounding buildings or distributed heating grid.
- H Start up from outdoor temperature or room temperature takes rather long time, this is mainly due to the large amount of ceramic material which require slow heating ramps. If the system is at operating temperature the stack can be started up quickly, assuming that gases are supplied and help systems are active. Also shut down can be performed quickly, not counting in the time required to cool the system.
- I The best estimates for nominal investments in 2020, 2030 and 2050 are estimated from [9]. In 2020 an annual production of 50 units is assumed, in 2030 a yearly production of 250 units is assumed, and in 2050 a production of 4000 units per year is assumed.
- J Estimation of uncertainties for investment costs are estimated from [9] with an annual production of 10/150 units in 2020 and 1000/10000 units in 2050
- K Fixed O&M costs are estimated as 5% of the investment cost.
- L The heat efficiency, which can be derived, depends on the return temperature of the cooling circuit and the size of the heat exchanger.

## References

- [1] BloomEnergy, [www.bloomenergy.com](http://www.bloomenergy.com), 2014-11-11,
- [2] Technology, <https://www.mhps.com/en/technology/index.html>, 2014-11-14.
- [3] BloomEnergy, *Product datasheet: ES-5710 Energy Saver*, November 2014:  
[http://c0688662.cdn.cloudfiles.rackspacecloud.com/downloads\\_pdf\\_Bloomenergy\\_DataSheet\\_ES-5710.pdf](http://c0688662.cdn.cloudfiles.rackspacecloud.com/downloads_pdf_Bloomenergy_DataSheet_ES-5710.pdf).
- [4] BloomEnergy, *Product datasheet: ES-5700 Energy Saver*, November 2014:  
[http://c0688662.cdn.cloudfiles.rackspacecloud.com/downloads\\_pdf\\_Bloomenergy\\_DataSheet\\_ES-5700.pdf](http://c0688662.cdn.cloudfiles.rackspacecloud.com/downloads_pdf_Bloomenergy_DataSheet_ES-5700.pdf).
- [5] Iskov H., Rasmussen N.B., Danish gas Technology centre, 2013, *“Update of technology data for energy plants: Fuel cells, electrolysis and technologies for bio-SNG”*.
- [6] Fuel Cell and Hydrogen Joint Undertaking: *“Multi – Annual Work Plan 2014-2020”*, adopted 2014-06-30.
- [7] <http://www.asue.de>, 2014-11-17.
- [8] Bloom Energy Server, [http://en.wikipedia.org/wiki/Bloom\\_Energy\\_Server](http://en.wikipedia.org/wiki/Bloom_Energy_Server), 2015-02-02.
- [9] Cogeneration in public facilities - flexible and green, <http://www.sunfire.de/en/applications/commercial>, 2016-08-31.
- [10] Convion product focus, <http://convion.fi/products/>
- [11] UPM-571 Uninterruptible Power Module, <http://www.bloomenergy.com/fuel-cell/upm-571-data-sheet/>, 2016-08-31.
- [12] International Energy Agency, 2015, *Technology Roadmap - Hydrogen and Fuel Cells*.
- [13] Pacific Northwest National Laboratory, 2013, *Cost Study for Manufacturing of Solid Oxide Fuel Cell Power Systems*, prepared for the U.S. Department of Energy.
- [\*] An asterisk in the data sheets reference indicate high uncertainty or "guesstimate", where more certain data where not available

## 12 Low temperature proton exchange membrane fuel cell CHP (hydrogen)

### Contact information:

Danish Energy Agency: Rikke Næraa, [rin@ens.dk](mailto:rin@ens.dk)

Energinet: Rune Grandal, [rdg@energinet.dk](mailto:rdg@energinet.dk)

Author: Dantherm. Adaptation from *Technology Data for Hydrogen Technologies* by Ea Energy Analyses

Review: DGC

### Publication date

March 2018

### Amendments after publication date

| Date | Ref. | Description |
|------|------|-------------|
| -    | -    | -           |
| -    | -    | -           |

## Qualitative description

### Brief technology description

Fuel cells are electrochemical devices that convert fuel into electricity and heat. Generally, the conversion efficiency from fuel to electricity is high in a fuel cell and the technology is scalable without loss of efficiency. The proton exchange membrane (PEM) fuel cell consists of a cathode and an anode made of graphite and a proton-conducting polymer as the electrolyte as shown in Figure 1 [1].

Low temperature PEM fuel cells operate at temperatures below 100°C (typically around 80°C) since the membrane must be saturated by water.

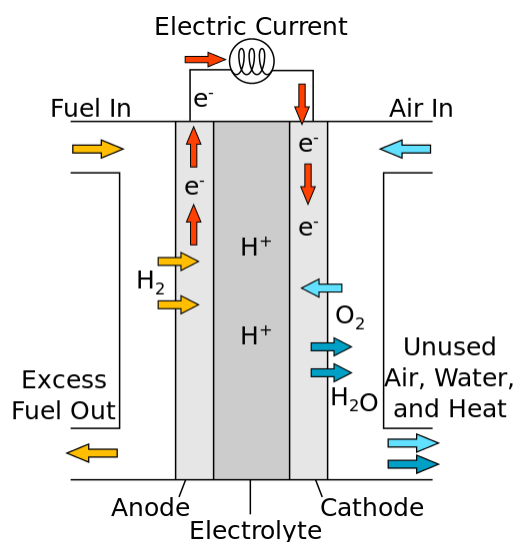

Figure 1: Diagram of a PEM-FC [2].

Today, the larger power and heat generating units FC-CHP are typically arranged for integration in conjunction with industrial processes where hydrogen is a waste gas from the industrial processes e.g. production of chloric gas. In many



of the early units, only the electricity as output is used. In the future, the hydrogen used for the fuel cell may be produced from electrolysis based on fossil free electricity.

Additionally, the potential of the LT-PEM fuel cell for transport purposes and within the area of mCHP installations has been estimated to be significant [1].



Figure 2: A 50 kW LT-PEMFC CHP hydrogen unit from Dantherm Power.

### Input

Hydrogen.

### Output

Electricity and heat.

### Typical capacities

The larger FC-CHP units are typical around 20 to 1,000 kW of electrical power.

### Regulation ability

The technology has good part-load and transient properties. The regulation of PEM systems can be designed to achieve close to 0% nominal load without significant loss of efficiency. Furthermore, the start-up time of the technology is short and the fuel cells can start and operate at room temperature and has no problems with frequent thermal cycling (start/stop). Response time from cold start during hard frost is very short – down to a few seconds.

### Advantages/disadvantages

The main advantages include:

- The PEM-FC utilises the scalability of the fuel cell technology to produce electricity locally with efficiencies equal to or higher than for conventional power plants.
- Larger FC-CHP units in the grid can support the grid companies in balancing the grid.
- The grid balancing property of the PEM-FC contributes to reduced additional investments in infrastructure e.g. cables.

- Hydrogen produced from excess electricity based on renewable sources can be stored in hydrogen storages and utilised in the PEM-FC in situations, where wind turbines, solar PV and other renewable technologies are not available.

The main disadvantages include:

- Relatively high production costs today due to expensive materials (platinum).
- The lifetime of the current technology needs to be improved.

### Environment

If the hydrogen is produced from fossil free electricity, the operation of the LT-PEMFC is carbon neutral.

The exhaust gas does not contain NO<sub>x</sub> and SO<sub>2</sub>.

### Research and development perspectives

The Danish research, development and demonstration program on fuel cell based CHP is of international level compared to similar programs in Germany, Japan, Korea and North America.

The fuel cell technology has shown high electrical efficiency above the efficiencies of competing power generation technologies. However, the fuel cell technology still needs to be matured on issues like lifetime and cost reduction. It is expected that the Danish fuel cell technology will mature to a commercial level within this decade.

### Examples of market standard technology

Demonstration plants of 50 kW FC-CHP units were produced by Dantherm Power in 2010 and 2011 and delivered to South Africa and South Korea. A 1,000 kW unit from Nedstack was set in operation in 2011 in Arnhem, Holland; the Ballard Power Systems 1,000 kW unit has been in operations in California since 2012.

### Prediction of performance and costs

Since the technology is still relatively immature, the technology is placed in Category 2: Pioneer phase, demonstration. This also means that there is significant uncertainty related to the projection of future costs, which relate to both overcoming technological challenges and the future market and demand for the technology.

In the Technology Data for Hydrogen Technologies [4], the investment costs are projected to decrease to 1.1 M€<sub>2015</sub>/MW by 2030 and 0.8 M€<sub>2015</sub>/MW by 2050. For comparison the IEA projects a decrease from 1.5 M€/MW in 2020 to 0.7 M€/MW in 2030 and 0.6 M€/MW by 2050, in its Technology Roadmap - Hydrogen and Fuel Cells, 2015.

The typical generation capacity is expected to increase from around 0.1 MW in 2020 to approximately 2 MW in 2050, while the electrical efficiency is expected to increase to 50%.

### Uncertainty

The uncertainty related to the cost projection is significant and is affected by challenges such as lifetime improvements, introduction of cheaper materials and improved market share resulting in economy of scale synergies. The uncertainty of the cost projection in 2050 is estimated to be +/- 50%.

### Economy of scale

-

### Additional remarks

No additional remarks.

Data sheets

| Technology  | LT-PEMFC CHP hydrogen gas |        |        |        |                    |                    |       |       | Note | Ref  |
|---|---------------------------|--------|--------|--------|--------------------|--------------------|-------|-------|------|------|
|   | 2015                      | 2020   | 2030   | 2050   | Uncertainty (2020) | Uncertainty (2050) |       |       |      |      |
| <b>Energy/technical data</b>  |                           |        |        |        |                    |                    |       |       |      |      |
|   |                           |        |        |        | Lower              | Upper              | Lower | Upper |      |      |
| Generating capacity for one unit (MWe)  | 0.05                      | 0.1    | 1      | 2      |                    |                    |       |       |      | 1    |
| Electricity efficiency (condensation mode for extraction plants), net (%), name plate     | 45                        | 50     | 50     | 50     |                    |                    |       |       |      | 1    |
| Electricity efficiency (condensation mode for extraction plants), net (%), annual average | 45                        | 50     | 50     | 50     | 45                 | 52                 | 46    | 53    | A    | 1, 2 |
| Cb coefficient (50°C/100°C)   | -                         | 1.25   | 1.25   | 1.25   |                    |                    |       |       | D    |      |
| Cv coefficient (50°C/100°C)   | -                         | -      | -      | -      |                    |                    |       |       |      |      |
| Forced outage (%)   | 0.1                       | 0.1    | 0.1    | 0.1    |                    |                    |       |       |      |      |
| Planned outage (weeks per year)   |                           | 0.1    | 0.1    | 0.1    |                    |                    |       |       |      |      |
| Technical lifetime (years)  | 10                        | 10     | 10     | 10     |                    |                    |       |       |      | 1    |
| Construction time (years)   | 1                         | 1      | 1      | 1      |                    |                    |       |       |      |      |
| <b>Regulation ability</b>   |                           |        |        |        |                    |                    |       |       |      |      |
| Primary regulation (% per 30 seconds)   | 50                        | 25     | 2.5    | 1.25   |                    |                    |       |       |      |      |
| Secondary regulation (% per minute)   |                           |        |        |        |                    |                    |       |       |      |      |
| Minimum load (% of full load)   | 10                        | 10     | 10     | 10     |                    |                    |       |       |      |      |
| Warm start-up time (hours)  | 0.01                      | 0.01   | 0.01   | 0.01   |                    |                    |       |       |      |      |
| Cold start-up time (hours)  |                           |        |        |        |                    |                    |       |       |      |      |
| <b>Environment</b>  |                           |        |        |        |                    |                    |       |       |      |      |
| SO <sub>2</sub> (degree of desulphuring, %)   | 100                       | 100    | 100    | 100    |                    |                    |       |       |      |      |
| NO <sub>x</sub> (g per GJ fuel)   | 0                         | 0      | 0      | 0      |                    |                    |       |       |      |      |
| CH <sub>4</sub> (g per GJ fuel)   | 0                         | 0      | 0      | 0      |                    |                    |       |       |      |      |
| N <sub>2</sub> O (g per GJ fuel)  | 0                         | 0      | 0      | 0      |                    |                    |       |       |      |      |
| <b>Financial data</b>   |                           |        |        |        |                    |                    |       |       |      |      |
| Nominal investment (M€/MW)  | 1.9                       | 1.3    | 1.1    | 0.8    | 1.1                | 1.6                | 0.5   | 0.9   | B    | 3, 2 |
| - of which equipment  | 1.6                       | 1.0    | 0.8    | 0.6    |                    |                    |       |       |      | 3    |
| - of which installation   | 0.3                       | 0.3    | 0.3    | 0.2    |                    |                    |       |       |      | 3    |
| Fixed O&M (€/MW/year)   | 95,000                    | 65,000 | 55,000 | 40,000 |                    |                    |       |       | C    |      |
| Variable O&M (€/MWh)  |                           |        |        |        |                    |                    |       |       |      |      |
| <b>Technology specific data</b>   |                           |        |        |        |                    |                    |       |       |      |      |
| Minimum load efficiency (%)   | 30                        | 35     | 35     | 35     |                    |                    |       |       |      | 1    |

### Notes:

- A Uncertainties for efficiency based on [2]
- B Estimation of uncertainties for nominal investment costs based on [2]
- C Fixed O&M costs are estimated to 5% of the investment cost based on [2]
- D The heat efficiency, which can be derived, depends on the return temperature of the cooling circuit and the size of the heat exchanger.

### References

- [1] Partnerskabet for brint og brændselsceller, *Fuel Cell Technologies*, <http://www.hydrogennet.dk/358/>, visited 01.11.2016.
- [2] Wikipedia, Proton exchange membrane fuel cell, [https://en.wikipedia.org/wiki/Proton\\_exchange\\_membrane\\_fuel\\_cell](https://en.wikipedia.org/wiki/Proton_exchange_membrane_fuel_cell), visited 01.11.2016.
- [3] International Energy Agency. 2015. *Technology Roadmap - Hydrogen and Fuel Cells*.
- [4] Ea Energy Analyses et al. 2016, *Technology Data for Hydrogen Technologies*.
- [5] Practical data and expert opinion from Dantherm Power

## 20 Wind Turbines onshore

### Contact information:

Danish Energy Agency: Thøger Kiørboe, TKI@ens.dk

Author: Mads V. Sørensen /Henrik Sundgård Petersen / Per Nielsen (EMD)

### Publication date

August 2016

### Amendments after publication date

| Date   | Ref.                     | Description   |
|--------|--------------------------|---|
| May 19 | 20 Wind turbines onshore | Financial and technical data updated in data sheets |

#### Note to Amendment May 2019:

A significant reduction in turbine costs has been observed in the past years. Also, a faster development in rotor size than expected in the 2016 version has been observed. Larger generators, larger hub heights and larger rotors have all contributed to increase the electricity generation from wind turbines. However, the most radical change is related to service costs. These are reduced by approximately 50% since the 2016 version of this chapter. At the same time electricity prices has increased in recent year which makes onshore wind turbines close to independent of subsidies. This is illustrated by the results of the first Danish auction (finalized in late 2018) where the average feed-in premium was as low as 2.27 øre/kWh (both onshore wind and solar PV). Also the first subsidy-free onshore project was announced in March 2019.

Since the 2016 version of this chapter additional cost components has been included in the data sheets. These include land purchase, compensations to neighbours, purchase of neighbour settlements and purchase of old turbines.

Besides the cost reductions, also technical improvements have been seen. More advanced control of the turbines continues to develop. An example is “power boost”, where the turbine will run above rated power when the conditions allow (like generator temperature). This means added production at the part of the power curve where the turbine starts to reduce output. Also, high wind “ride through” is seen, where the turbine does not stop at 25 m/s but continue to operate. This does not give much extra production but can be a huge advantage for the grid. Shutdown of 5 GW wind power within few hours when a hurricane arrive, is a huge challenge for grid operation. A new “control” is in test now, where a wind farm is controlled in a way that maximizes the output for the total wind farm, by detailed control of each turbine to minimize wake losses and at the same time reduce loads.

The new control strategies, however, do not add significant amounts of annual production, probably only a few percent extra.

## Qualitative description

### Brief technology description

The typical large onshore wind turbine being installed today is a horizontal-axis, three bladed, upwind, grid connected turbine using active pitch, variable speed and yaw control to optimize generation at varying wind speeds.

Wind turbines work by capturing the kinetic energy in the wind with the rotor blades and transferring it to the drive shaft. The drive shaft is connected either to a speed-increasing gearbox coupled with a medium- or high-speed generator, or to a low-speed, direct-drive generator. The generator converts the rotational energy of the shaft into electrical energy. In modern wind turbines, the pitch of the rotor blades is controlled to maximize power production at low wind speeds, and to maintain a constant power output and limit the mechanical stress and loads on the turbine at

high wind speeds. A general description of the turbine technology and electrical system, using a geared turbine as an example, can be seen in figure 1.

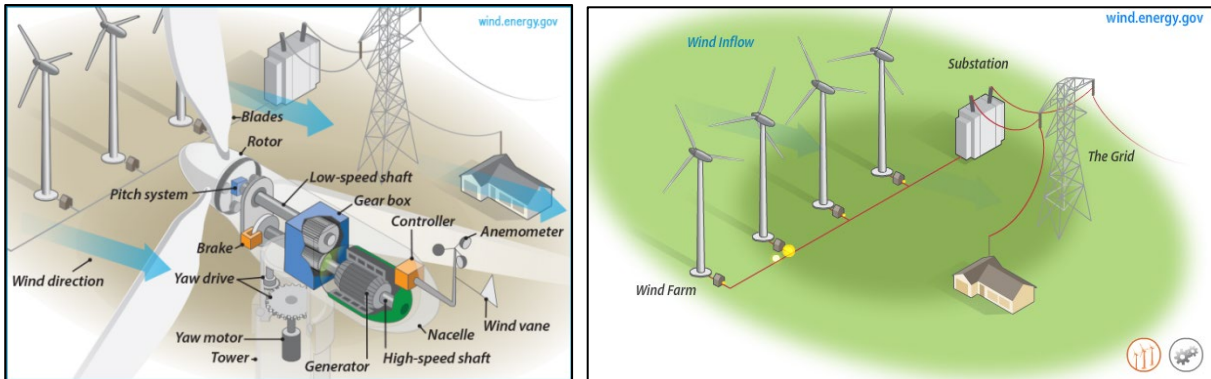

**Figure 1** General turbine technology and electrical system.

Wind turbines are designed to operate within a wind speed range which is bounded by a low “cut-in” wind speed and a high “cut-out” wind speed. When the wind speed is below the cut-in speed the energy in the wind is too low to be utilized. When the wind reaches the cut-in speed, the turbine begins to operate and produce electricity. As the wind speed increases, the power output of the turbine increases, and at a certain wind speed the turbine reaches its rated power. At higher wind speeds, the blade pitch is controlled to maintain the rated power output. When the wind speed reaches the cut-out speed, the turbine is shut down or operated in a reduced power mode to prevent mechanical damage.

Onshore wind turbines can be installed as single turbines, clusters or in larger wind farms.

Commercial wind turbines are operated unattended and are monitored and controlled by a supervisory control and data acquisition (SCADA) system.

**Input**

Input is wind.

Cut-in wind speed: 3 – 4 m/s.

Rated power generation wind speed: 10-12 m/s, depending on the specific power (defined as the ratio of the rated power to the swept rotor area).

Cut-out or transition to reduced power operation at wind speed: 25 m/s.

In the future, it is expected that manufacturers will apply a soft cut-out for high wind speeds (indicated with dashed red curve in Figure 2) resulting in a final cut-out wind speed around 30 m/s.

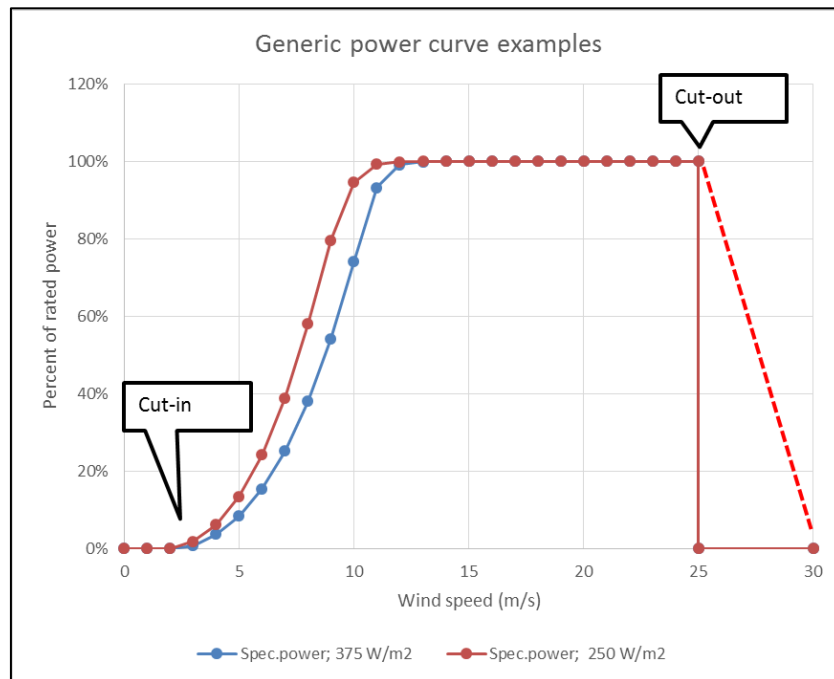

Figure 2 Turbine power curves (Information's from expert workshop held by DEA 27-4-2015). Specific power values refer to e.g. 3 MW with 124m rotor diameter (250 W/m2) and 3 MW with 101 m rotor diameter (375 W/m2)

The power in the wind is given by the formula  $P = \frac{1}{2} \cdot \rho \cdot A \cdot u^3$ , where  $\rho$  is the air density,  $A$  the swept area and  $u$  the wind speed. To calculate the net power output from a wind turbine, the result must be multiplied by  $C_p$  (Coefficient of power).  $C_p$  varies with wind speed and has a maximum of around 45%, which is typically reached at  $\sim 8$  m/s, depending on the specific power.

**Output**

The output is electricity.

Typical modern onshore turbines located in Denmark have capacity factors in the range of 35%, corresponding to 3100 annual full load hours. Typical duration curves are presented in Figure 3.

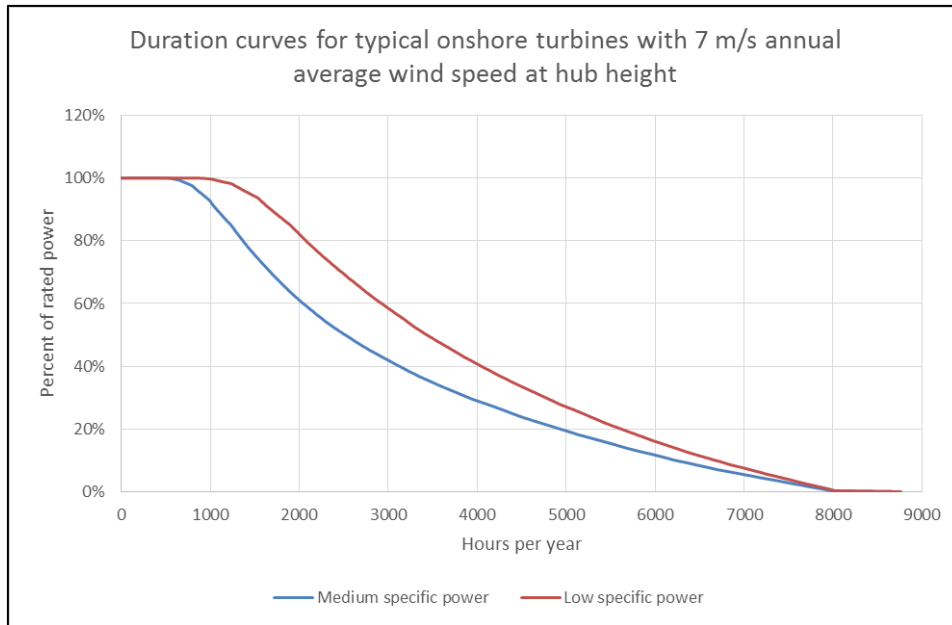

Figure 3 Duration curve for typical modern onshore wind turbines (> 2 MW) located in Denmark (DTU International Energy Report - Wind Energy, 2014). The two curves are based on the V117 3.3 MW (307 W/m<sup>2</sup>) and V126 3.3 MW (265 W/m<sup>2</sup>) wind turbines.

The annual energy output of a wind turbine is strongly dependent on the average wind speed at the turbine location. The average wind speed depends on the geographical location (with North-western Jutland being the windiest part of Denmark), the hub height, and the surface roughness. Hills and mountains also affect the wind flow, but as Denmark is very flat, the local wind conditions are normally dominated by the surface roughness. Also, local obstacles like forest and for small turbines buildings and hedges reduce the wind speed like wakes from neighbour turbines reduces.

The surface roughness is normally classified according to the following table:

Table 1: Description of classification of surface roughness

| Roughness class | Roughness Length (m) <sup>10</sup> | Description  |
|-----------------|------------------------------------|--|
| 0               | 0.0002                             | Water  |
| 1               | 0.03                               | Open farmland  |
| 2               | 0.1                                | Partly open farmland with some settlements and trees |
| 3               | 0.4                                | Forest, cities, farmland with many windbreaks        |

<sup>10</sup> The roughness length is the height above ground level, where average wind speed is 0. The wind speed variation with height is governed by the roughness length.



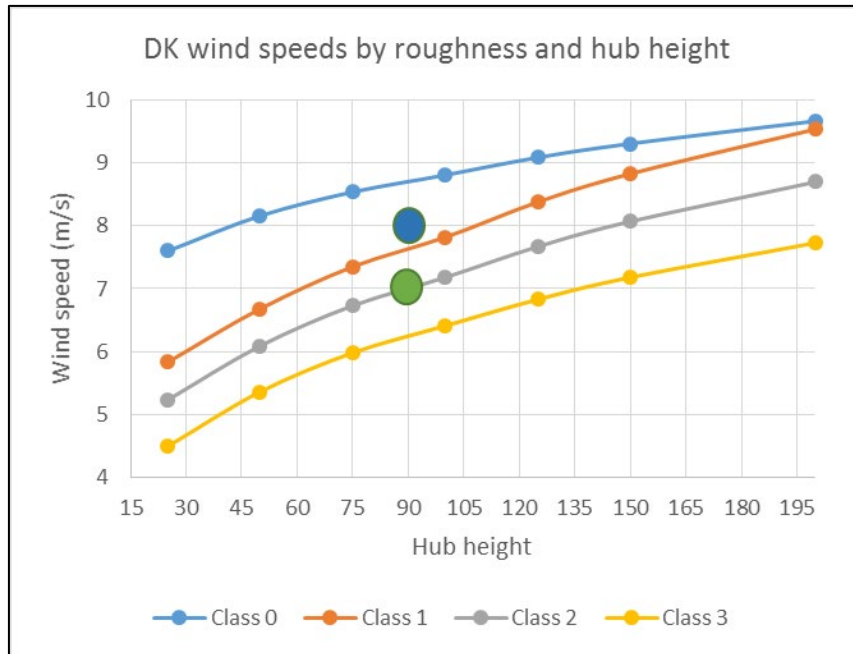

Figure 4 Annual average wind speeds as a function of hub height and roughness class for flat terrain. The green dot represents a typical modern inland site; the blue dot represents a typical coastal site. The typical hub height is 90 m.

Figure 4 shows the average wind speeds by hub height and roughness class for flat terrain. Onshore wind turbines installed in Denmark today typically have a hub height of 85-90 m. On a typical inland site the average wind speed is around 7 m/s, whereas on a typical coastal site the average wind speed is around 8 m/s. An increase in the average wind speed from 7 to 8 m/s results in a roughly 25% increase in annual energy production.

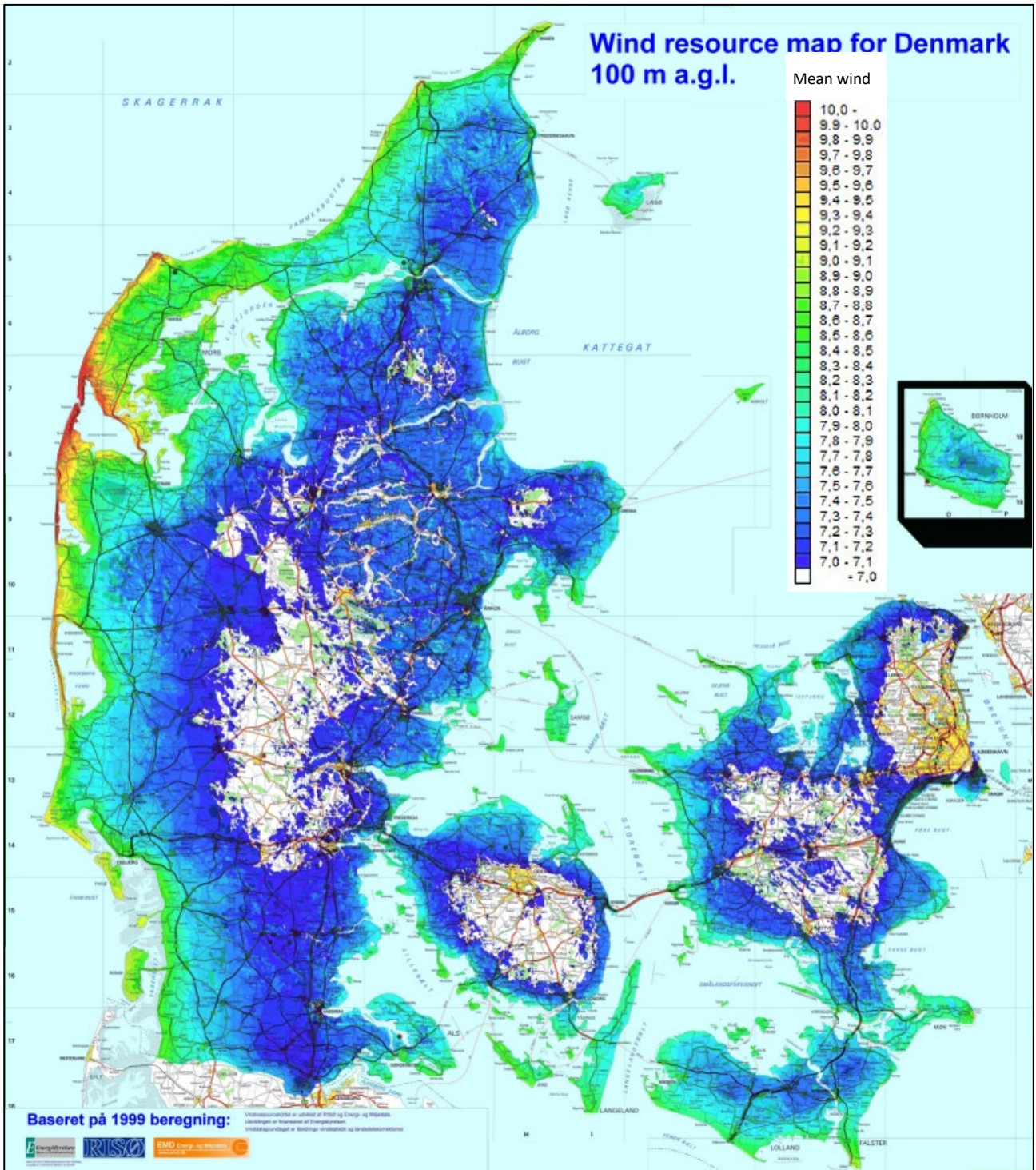

Figure 5 Wind resource map for Denmark in 200 m resolution, 100 m above terrain .

The wind resource map for Denmark (Figure 5) shows the regional differences. As seen, the regions close to the sea in dominating wind directions (west-southwest) that have the highest wind resource. This is a result of the low surface roughness in the upwind direction. The white areas have average wind speeds below 7 m/s at 100 m height above terrain.

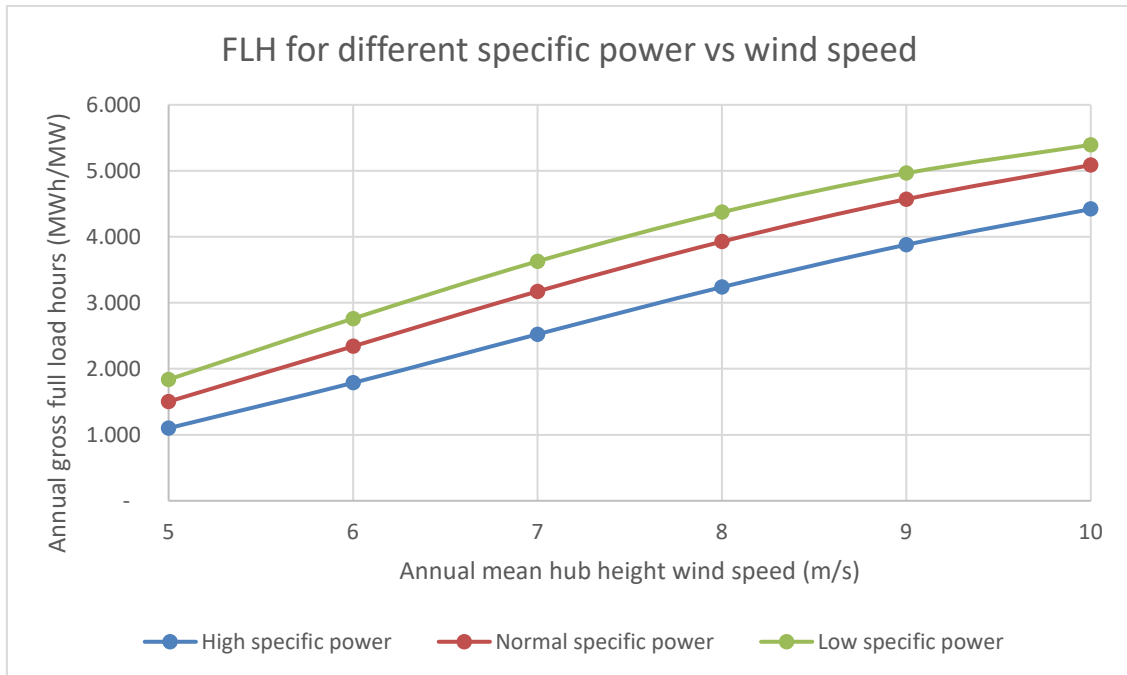

Figure 6 Annual full load hours as a function of mean wind speed at hub height. The examples in the figure are 3 MW with 90m rotor diameter, specific powers are 472 W/m<sup>2</sup> called “high specific power” and 3.3 MW turbines with 112 m and 126 m rotor diameters, specific powers are 335 W/m<sup>2</sup> called “medium specific power” and 265 W/m<sup>2</sup> called “low specific power”.

Figure 6 illustrates the importance of the annual mean wind speed as well as the specific power for the annual energy production (AEP). It is seen that the increase in AEP is almost linear with mean wind speed in the range from 6m/s to 9 m/s. Future turbines are expected to have even lower specific power than the “low” example in above figure.

### Typical capacities and development statistics

Onshore wind turbines can be categorized according to nameplate capacity. At the present time new installations are in the range of 2 to 6 MW. Another category is domestic wind turbines which is micro and small wind turbine in the range of 1 -25 kW, see separate paragraph on domestic turbines.

Two primary design parameters define the overall production capacity of a wind turbine. At lower wind speeds, the electricity production is a function of the swept area of the turbine rotor. At higher wind speeds, the power rating of the generator defines the power output. The interrelationship between the mechanical and electrical characteristics and their costs determines the optimal turbine design for a given site.

The size of wind turbines in Denmark has increased steadily over the years. Larger generators, larger hub heights and larger rotors have all contributed to increase the electricity generation from wind turbines. Lower specific capacity (increasing the size of the rotor area more than proportionally to the increase in generator rating) improves the capacity factor (energy production per generator capacity), since power output at wind speeds below rated power is directly proportional to the swept area of the rotor. Furthermore, the larger hub heights of larger turbines provide higher wind resources in general.

The average rated power of new onshore wind turbines in Denmark has increased by a factor of three since year 2000 (Figure 7 below). Although project developers consider larger turbines to be the most attractive, the increase in rated power is not constant, partly because some older projects with smaller turbines have been expanded with more (small) turbines, and partly because some projects are established with smaller turbines than the “optimal” size due to lack of space.

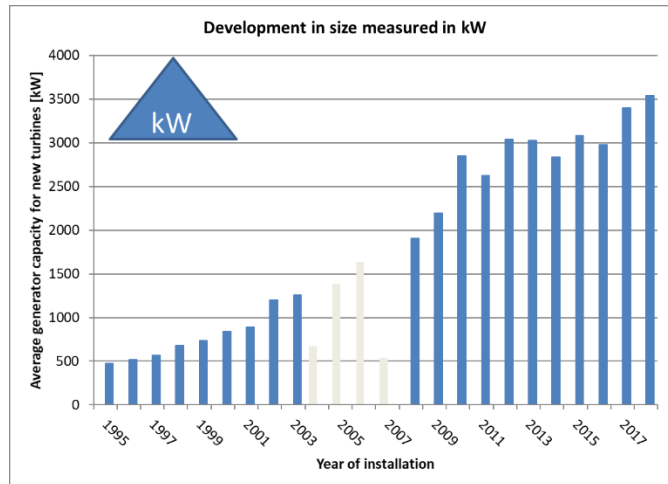

Figure 7 Average generator capacity for new turbines (rated power > 25 kW) [3]

In the same period the rotor diameters and hub heights have also increased as illustrated in Figure 8 and Figure 9.

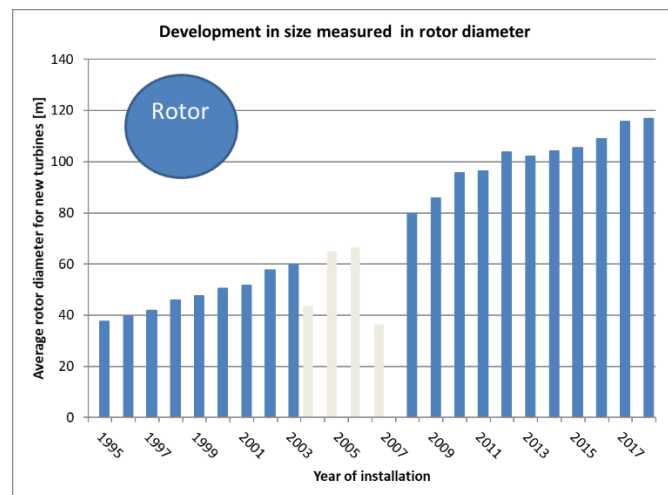

Figure 8 Average rotor diameter for new turbines (rated power > 25 kW) [3]

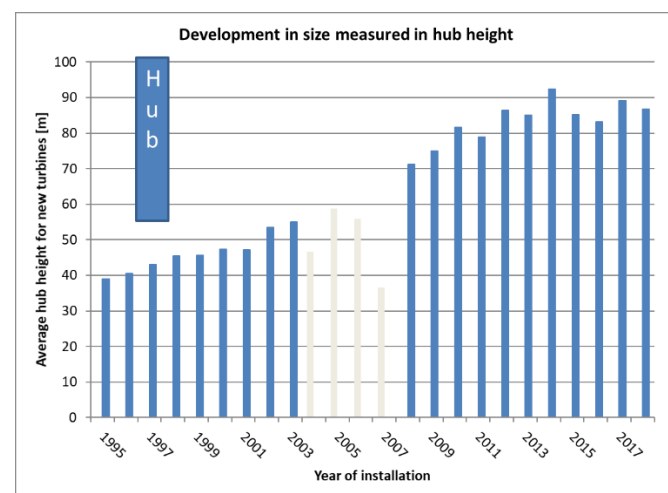

Figure 9 Average hub height for new turbines (rated power > 25 kW) [3]

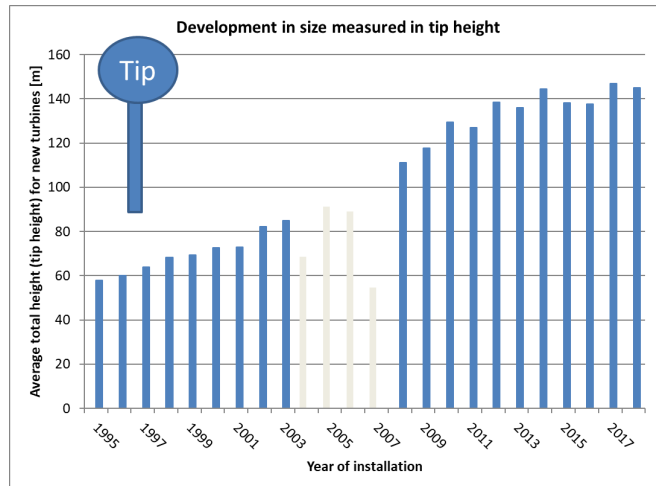

Figure 10 Average tip height for new turbines (rated power > 25 kW) [3]

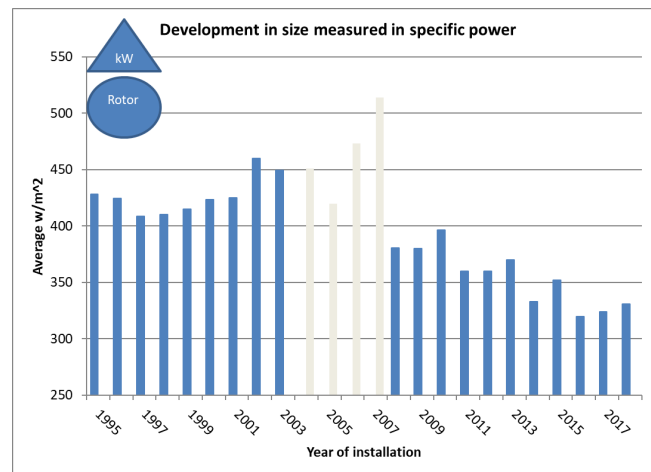

Figure 11 Average specific power for new turbines (rated power > 25 kW) [3]

The specific power has decreased for turbines installed in Denmark over the last 10 years. Formerly, turbines often had specific power values on the order of 400-450 W/m<sup>2</sup>. Since 2010 the average specific power has generally been less than 375 W/m<sup>2</sup>. In combination with improvements in turbine efficiency and an increase in average hub heights, this has resulted in increasing capacity factors. On average, capacity factors for Danish onshore turbines installed before 2000 were below 25% (corresponding to 2200 full load hours), while the average capacity factors for Danish onshore turbines installed after 2010 are typically in the order of 30-35% (corresponding to 2600-3100 full load hours). The trend towards larger rotors and lower specific power is global.

Due to current planning, environmental and civil aviation regulations wind turbines to be installed onshore in Denmark are generally limited to a maximum height of 150 m from the ground to the highest point i.e. rotor tip. In 2018 the average total height (tip height) was 145 m [4]. However, exemptions from the 150 m limit are granted for test sites. Elsewhere in Europe there is a strong trend towards approval of maximum heights above 150 m. Removal of the 150 m limitation is currently being processed and is expected to be removed from the Danish regulations in 2019.

**Regulation ability and power system services**

Electricity from wind turbines is highly variable because it depends on the actual wind resource available. Therefore, the regulation capability depends on the weather situation. In periods with calm winds (wind speed less than 4-6 m/s) wind turbines cannot offer regulation, with the possible exception of voltage regulation.

With sufficient wind resource available (wind speed higher than 4-6 m/s and lower than 25-30 m/s) wind turbines can always provide down regulation, and in many cases also up regulation, provided the turbine is running in power-curtailed mode (i.e. with an output which is deliberately set below the possible power based on the available wind).



In general, a wind turbine will run at maximum power according to the power curve (c.f. Figure 2) and up regulation is only possible if the turbine is operated at a power level below the power actually available. This mode of operation is technically possible and, in many countries, turbines are required to have this feature. However, it is rarely used, since the system operator will typically be required to compensate the owner for the reduced revenue [5].

Wind turbine generation can be regulated down quickly, and this feature is regularly used for grid balancing. The start-up time from no production to full operation depends on the wind resource available.

New types of wind turbines (DFIG and converter based) also have the ability to provide supplementary ancillary services to the grid such as reactive power control, spinning reserve, inertial response, etc. However, these supplementary ancillary services from wind turbines are seldom utilized in Denmark, due to a lack of economic incentives. Older types of wind turbines typically deployed in Denmark before 2008 consume reactive power and can have a negative influence on voltage stability.

### Advantages/disadvantages

#### *Advantages:*

- No emissions to air from operation
- No emission of greenhouse gasses from operation
- Stable and predictable costs due to low operating costs and no fuel costs
- Modular technology allows for capacity to be expanded according to demand avoiding overbuilds and stranded costs
- Short lead time compared to most alternative technologies

#### *Disadvantages:*

- High capital investment costs
- Variable energy resource
- Moderate contribution to capacity compared to thermal power plants
- Need for regulating power
- Visual impact and noise

### Environment

Wind energy is a clean energy source. The main environmental concerns are visual impact, flickering from rapid shifts between shadow and light when turbine is between sun and settlement, noise and the risk of bat or bird-collisions.

The visual impact of wind turbines is an issue that creates some controversy, especially since onshore wind turbines have become larger.

Flickering is generally managed through a combination of prediction tools and turbine control. Turbines may in some cases need to be shut down for brief periods when flickering effect could occur at neighbouring residences.

Noise is generally dealt with in the planning phase. Allowable sound emission levels are calculated on the basis of allowable sound pressure levels at neighbours. In some cases, it is necessary to operate turbines at reduced rotational speed and/or less aggressive pitch setting in order to meet the noise requirements. Noise reduced operation may cause a reduction in annual energy production of 5-10%. Despite meeting the required noise emission levels turbines sometimes give rise to noise complaints from neighbours. In 2013 it was decided to investigate in detail how wind turbines and especially noise from wind turbines influence human health. The report concludes that<sup>11</sup>:

- No conclusive evidence was found of a correlation between short-term and long-term exposure to wind turbine noise and the occurrence of blood clots in the heart and stroke.

---

<sup>11</sup> <https://mst.dk/service/nyheder/nyhedsarkiv/2019/mar/undersogelse-om-helbredseffekter-af-vindmoellestoej-er-afsluttet/>

- The results of the study do not support a link between long-term exposure to wind turbine noise and newly emerging diabetes or between exposure to wind turbine noise during pregnancy and negative birth defects.
- For first-time redemption of prescriptions for sleep medication and antidepressant medicine, the researchers found a connection with high levels of outdoor wind turbine noise among the elderly over the age of 65 and weak indications of similar findings for first-time intake of prescriptions for medicines for the treatment of high blood pressure.
- The study generally includes few illnesses / pregnancies among the groups exposed to the highest noise levels, which is why the researchers demand that the results be reproduced by other researchers

A recent Canadian literature study concludes that wind turbines might cause annoyance at the neighbours, but no causal relation could be established between noise from wind turbines and the neighbour's health [7].

The risk of bird collisions has been of concern in Denmark due to the proximity of wind turbines to bird migration routes. In general, it turns out that birds are able to navigate around turbines, and studies report low overall bird mortality but with some regional variations [8].

The environmental impact from the manufacturing of wind turbines is moderate and is in line with the impact of other normal industrial production. The mining and refinement of rare earth metals used in permanent magnets is an area of concern [2, 9, 10].

The energy payback time of an onshore wind turbine is in several studies calculated to be in the order of 3-9 months [11, 12].

Life-cycle assessment (LCA) studies of wind farms have concluded that environmental impacts come from three main sources:

- bulk waste from the tower and foundations, even though a high percentage of the steel is recycled
- hazardous waste from components in the nacelle
- greenhouse gases (e.g. CO<sub>2</sub> from steel manufacturing and solvents from surface coatings)

### Research and development perspectives

R&D potential: [2, 13]

- Reduced investment costs resulting from improved design methods and load reduction technologies
- More efficient methods to determine wind resources, incl. external design conditions, e.g. normal and extreme wind conditions
- Improved aerodynamic performance
- Reduced operational and maintenance costs resulting from improvements in wind turbine component reliability
- Development in ancillary services and interactions with the energy systems
- Improved tools for wind power forecasting and participation in balancing and intraday markets
- Improved power quality. Rapid change of power in time can be a challenge for the grid
- Noise reduction. New technology can save the losses by noise reduced mode and possible utilize good sites better, where the noise set the limit of number of turbines
- Public acceptance
- Repowering strategies, like when it is feasible to repower for society and for investors – subsidy schemes must support optimal solutions
- Storage can improve value of wind power much, but is expensive at present

**Examples of best available technology**

Presently only Siemens and Vestas have commercially approved turbines suitable for Danish onshore projects. The wind turbines offered have rated power in the 2–5 MW range and rotor diameters of 80-150 m. Hub heights are typically in the range of 80-100 m within the current limit of 150 meter height. With the expected removal of the 150 meter limit, taller turbines with larger rotors will become possible in Denmark.

**Prediction of performance and cost**

*Cost breakdown of total capital costs for onshore wind turbines*

The 2020 estimate of capital costs is based on cost data for 12 onshore wind projects installed in 2017 and 2018.

The capital costs of onshore wind power projects are dominated by the cost of the wind turbine itself. The cost of grid connection has historically been covered by the Transmission System Operator (TSO) or Distribution System Operator (DSO) depending on the connection point. These costs do not appear in the cost breakdown from the 12 projects included in the analysis. Grid connections are generally 3 to 7 % of total investment costs.

Included in the cost breakdown are the following supplementary project costs (not included in previous version of the catalogue):

- Cost of land
- Compensation for loss of value for nearby settlements (Værditabsordningen)
- Purchase of existing turbines to be dismantled at site or nearby
- Purchase of nearby settlements to free space for the project

These costs are highly variable from project to project and can vary from 0% to round 25% of the total investment, depending on the local situation.

The cost breakdown based on 12 projects installed 2017-18 are shown below.

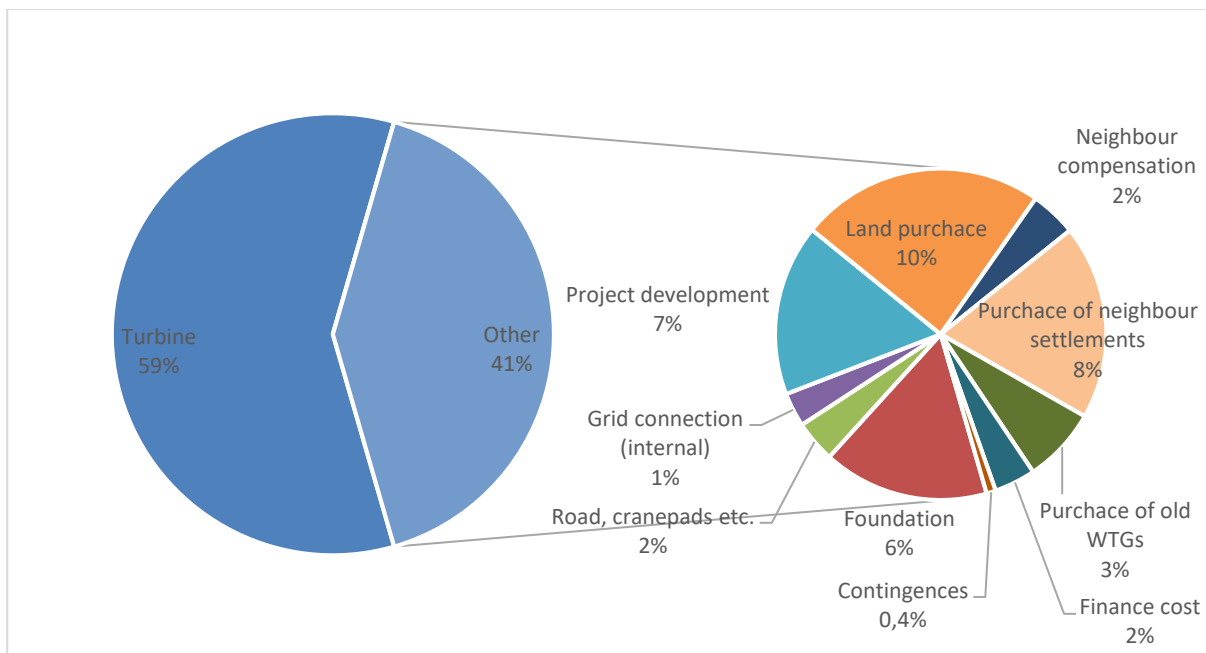

**Figure 12** The cost breakdown including land costs etc. from “køberetsordning” 2017-18 projects.

The costs of purchase of neighbour settlements, old WTGs and neighbour compensation might increase in future, while there is a trend towards larger projects that require more space and thereby added costs for the mentioned issues.

External grid costs are not included in the cost breakdown, while this cost so far has been covered by TSO or DSO as mentioned above. For future projects these shall be covered by the project. The costs are roughly estimated to 5% of all other costs. These costs can vary much by project location. In addition there will be expected added future cost for



a replacement of the “grøn ordning”, where roughly 10.000 €/MW could be obtained by municipalities for local initiatives with purpose of gain of acceptance.

There are four major components in operation and maintenance costs for wind turbines in Denmark: Service agreement, insurance, land rent/administration and repairs not covered by service agreement. Each cost component accounts historically roughly for 25% of Operating and Maintenance (O&M) costs over the lifetime of a wind turbine [4]. For more recent projects the trend is that the service agreement cover more and insurance and repair cost will represent a lower percentage.

A major part of the most recent onshore wind turbines is delivered with long term service contracts (more than 10-15 years) provided by the turbine manufacturers and a large part of the service/maintenance costs is known upfront. However, it is difficult to estimate the costs for repairs not covered by the service agreement, and even with long-term service agreements unforeseen cost may occur [15].

A study based on data for 2009 reports the expected lifetime costs for O&M for wind turbines installed in Denmark to be approximately €12/MWh (2015 prices) [4]. This is in accordance with the latest experience from the Danish Wind Turbine Owners association, which estimates a lifetime O&M-cost of 11 €/MWh (2015 prices) [15]. During 2018 an increased competition on service agreement is seen, where costs down to 50% of the years before are seen.

*Cost and production dependence of hub height and specific power*

To identify main drivers for future technology a deeper look is taken on how the production changes relative to the cost of the turbines by different parameter variations.

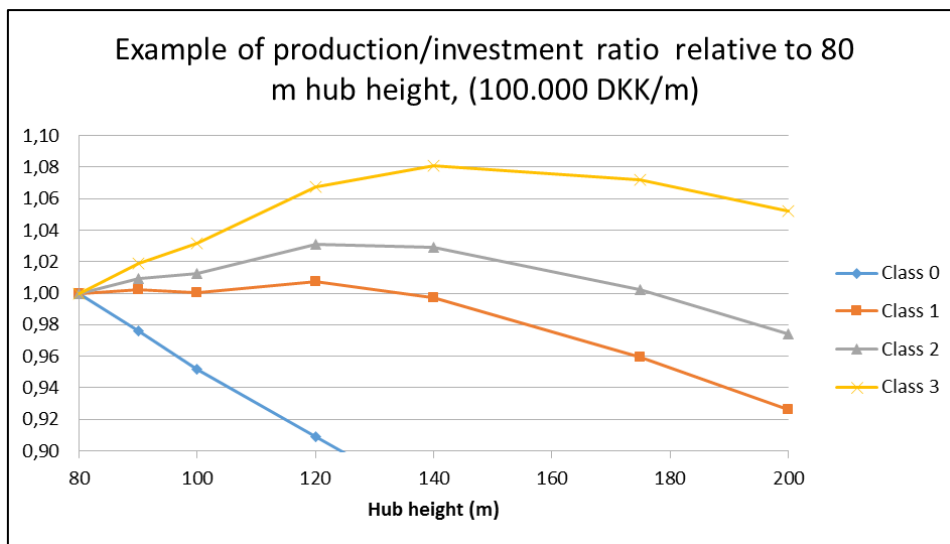

Figure 13 The production increase relative to the investment cost based on current available Vestas turbines. By increasing height, costs are extrapolated using DKK 100.000 per m hub height increase; the rotor area is kept constant.

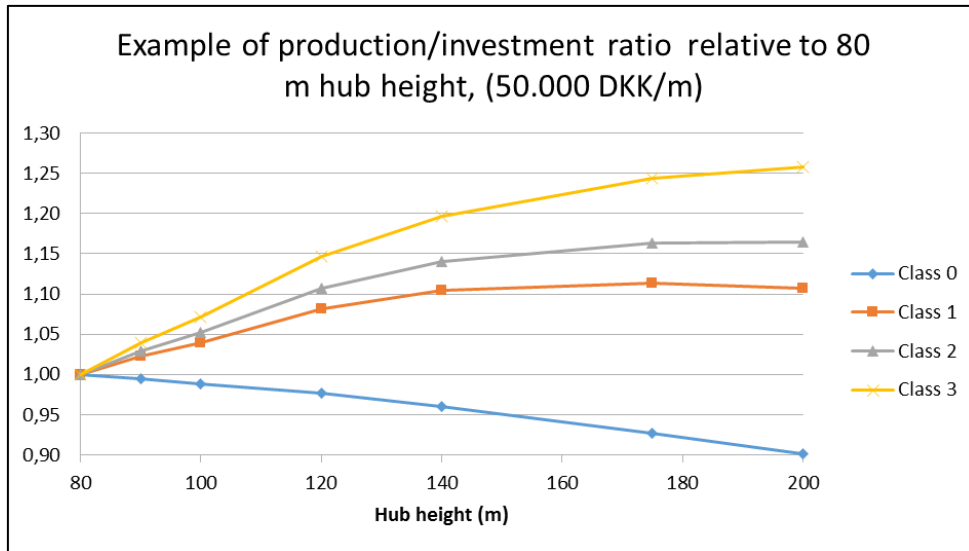

Figure 14 Similar, the production increase relative to the investment cost based on current available Vestas turbines, for increasing height, where costs are extrapolated using DKK 50.000 per m hub height increase, the rotor area is kept constant.

Figure 13 and Figure 14 demonstrate that except for in the offshore roughness class 0 hub heights above today's standard would lead to improved cost efficiency. In countries like Germany and Sweden, the improvements are generally at the higher end due to a higher average roughness class, and in the recent years 140m hub height are becoming common in commercial projects.

While the assumed cost increase of DKK 50-100.000 per meter hub height increase is within the range seen of present technologies, many other factors contribute to the cost increase with height, such as the specific tower technology, the project location relative to manufacturing, and the available cranes. Consequently, the cost increase will not be linear with height (as assumed in the figures), and the figures should be taken as a general illustration of the potential cost reductions by increased hub heights.

Example of production/investment ratio relative to 416 W/m<sup>2</sup> turbine, all 150 m total height

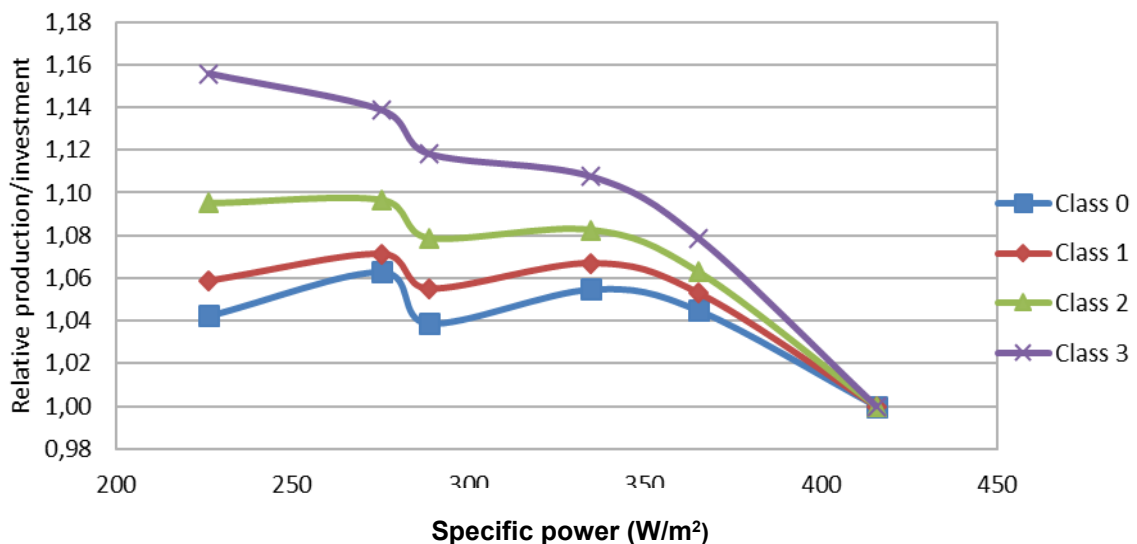

Figure 15 The production relative to the investment cost based on current available Vestas turbines for different rotor areas, generator size is 3.6 - 4 MW for all (= different specific power).

Figure 15 illustrates the potential benefits from reduction of the specific power. Turbine models with a specific power of less than 250 W/m<sup>2</sup> have up to 15% improvement in energy production per cost when comparing to the present model with highest specific power. If the improvement due to hub height increase would be included, even higher improvements would be seen.

To some extent the average capacity factors of onshore turbines installed since 2010 are affected by noise reduced operation due to noise regulations. Typically, noise reduced operation results in around 5% lower annual production than if non-noise reduced operation was possible. While the noise reduced mode will typically reduce around 5% with the Danish regulations, some higher reductions are seen in other countries.

*Prediction of cost in 2015*

The investment cost of wind turbines is expressed as investment per installed MW. This should however not stand alone when assessing the cost of the production of electricity from wind turbines. As mentioned before, the increase in hub height and rotor size of the turbine incurs additional investment costs per MW, but also increases the production per MW.

The development in the cost of wind turbines per installed MW and the numbers of full load hours are shown in Figure 16. Costs increased between 2002 and 2008. This was due to increased size and technical complexity of wind turbines and increased costs of steel, other raw materials and labour during this period, increased mark-ups by wind turbine manufacturers, and the effects of supply chain shortages for wind turbines and key components.

At the same time the electricity production per MW (annual full load hours) increased due to increases in the size and other technological improvements.

Figure 15 illustrates how the energy production (annual full load hours) and the investment cost has developed since 1995. In Figure 16 it is seen that in the recent years (2008-2014) the increase in energy production has been higher than the increase in investment costs.

The year-by-year variations are mainly a reflection of the sensitivity to the wind resource of actual project, rather than a year-to-year change in the technology used. Turbines installed during the period 2010-12 have the highest number of full load hours. This is probably most related to the fact that the majority of the turbines installed during this period are located in western Jutland which has the best wind resources in Denmark.

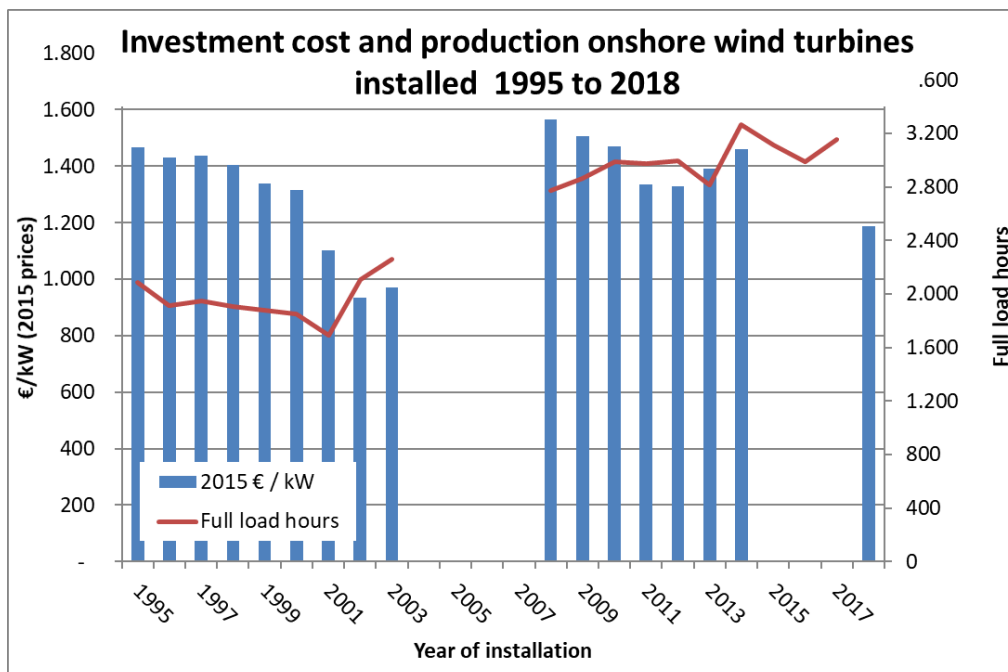

Figure 16 Development in investment cost (2015 price level) and average production (full load hours) for onshore turbines > 25 kW by installation year based on 2018 production [3, 16, 2]

Data from projects, which has been decided in 2013 and 2014 showed that the average investments costs for these projects are approximately 1450 k€/MW [14]. The costs of the installed projects 2017-18 was round 1200, all-inclusive land rent, neighbour compensations etc. This show a cost reduction of round 20% recent 4 years. The figure above does not include data for 2015-17, since the data basis not is detailed enough to give year by year data in this period.

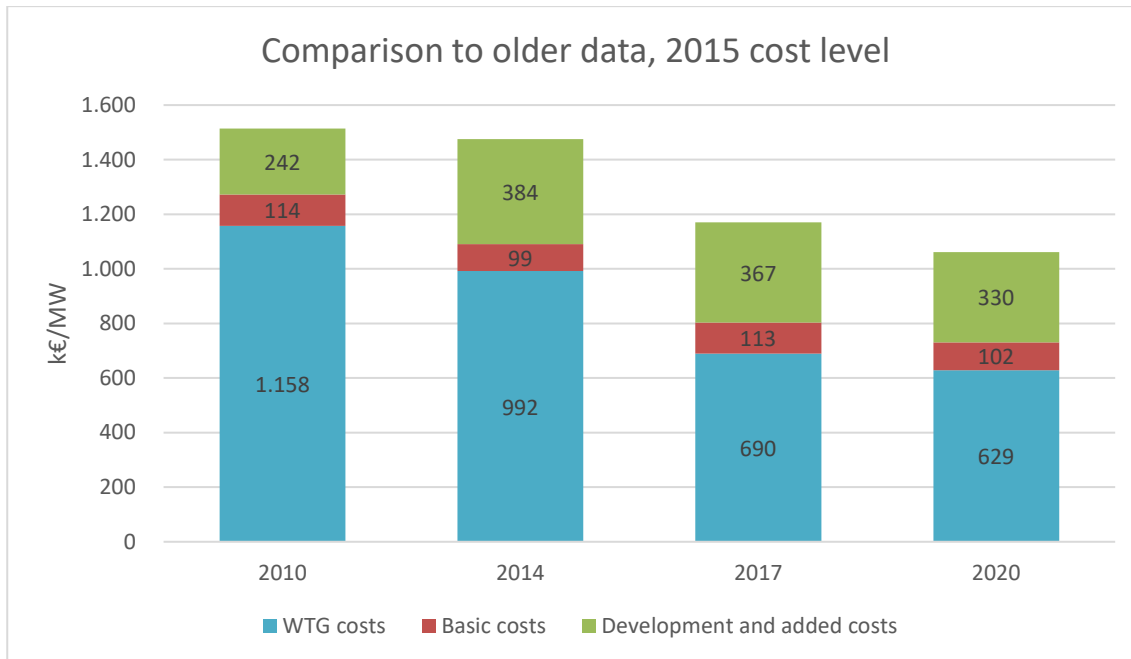

Figure 17 Development in average costs for "Køberets" projects together with 2020 estimate. Basic is foundation, roads and internal grid, the needed "hardware" in addition to the turbines. Development and added costs cover land rent, neighbor compensations and purchase of neighbour settlements and old turbines if such on the site or nearby. Grid connection costs are not included.

Note the WTG cost is reduced 45% from 2010 to 2020. The specific power has decreased 19% in same period, and thereby the production value of the cost reduction is even higher.

*Prediction of cost in the period from 2020 to 2050*

Onshore wind turbines can be seen as off-the-shelf products, but technology development continues at considerable pace, and the cost of energy has continued to drop. While price and performance of today's onshore wind turbines are well known, future technology improvements, increased industrialization, learning in general and economics of scale are expected to lead to further reductions in the cost of energy. Consequently, despite the fact that more than 350.000 MW of onshore wind has been deployed worldwide, onshore turbines are categorized as development category 3; *Commercial technologies with moderate deployment*, with a significant development potential and a considerable level of uncertainty related to future price and performance.

The annual specific production (capacity factor/full load hours) is expected to continue to increase; this is illustrated in Figure 19. The increase in production is mainly expected to be due to lower specific power, but also increased hub heights, especially in the regions with low wind, and improvement in efficiency within the different components is expected to contribute to the increase in production. This development should also be seen in relation to the fact that taller turbines with high capacity factor and low specific power will have higher market value. A study from 2017 [17] indicate that the market value of wind power in the wholesale market can be as much as 4.3 EUR/MWh higher for high capacity turbines than for low capacity factor turbines by 2030. This supports the expectation of higher annual production and lower specific power.

For the 2020 cost estimate, interviews with project developers etc. form the basis of the estimated costs. These data represent quotations that will be financially decided during 2019-20. The major change from the installed projects 2017-18 is the turbine costs, that decreases from 0.7 M€/MW to 0.63 M€/MW. While the new turbines have lower specific power (8% more rotor area/MW), the cost decrease measured in production is higher. This cost level is confirmed by several project developers. It shall be mentioned that for today's projects, the turbine cost and the service agreement

shall be seen together. Often cost reductions on the one part can be realised by increasing the other part. Project cost depends largely on timing and volume. One reason mentioned for the cost reduction is production of more components in China.

According to the report "Renewable Power generation cost in 2017", IRENA 2017 [18] the cost of onshore wind turbines has reduced on average by approximately 20% from 2010 to 2017, with large geographical variations. At the same time, the cumulative installed capacity increased by approximately 100%. The largest cost reductions have been realized in China and India. Hence, the learning rate for the investment cost for equipment, installation and development is set to 10% for every time the cumulative capacity is doubled. According to Bloomberg New Energy Finance, 2018 New Energy Outlook the capacity of onshore wind worldwide will approximately double in each of the periods 2020-2030 and 2030-2050. Hence, 10% learning rate is assumed from 2020-2030 and 10% from 2030-2050 within which the largest decrease happens between 2030 and 2040. Grid connection is assumed to be 5% of total investment costs (including land, decommissioning of existing turbines and other costs). The reduction rates can be seen in the table below and the resulting investment costs is illustrated in Figure 18.

|   | 2020-2030 | 2030-2040 | 2040-2050 |
|---|-----------|-----------|-----------|
| Equipment   | -10%      | -8%       | -2%       |
| Installation and development                        | -10%      | -8%       | -2%       |
| Grid connection                                     | -5%       | 0%        | 0%        |
| Rent of land  | 0%        | 0%        | 0%        |
| Decommissioning of existing turbines                | 0%        | 0%        | 0%        |
| Other costs (i.e. compensation of neighbours, etc.) | 0%        | 0%        | 0%        |

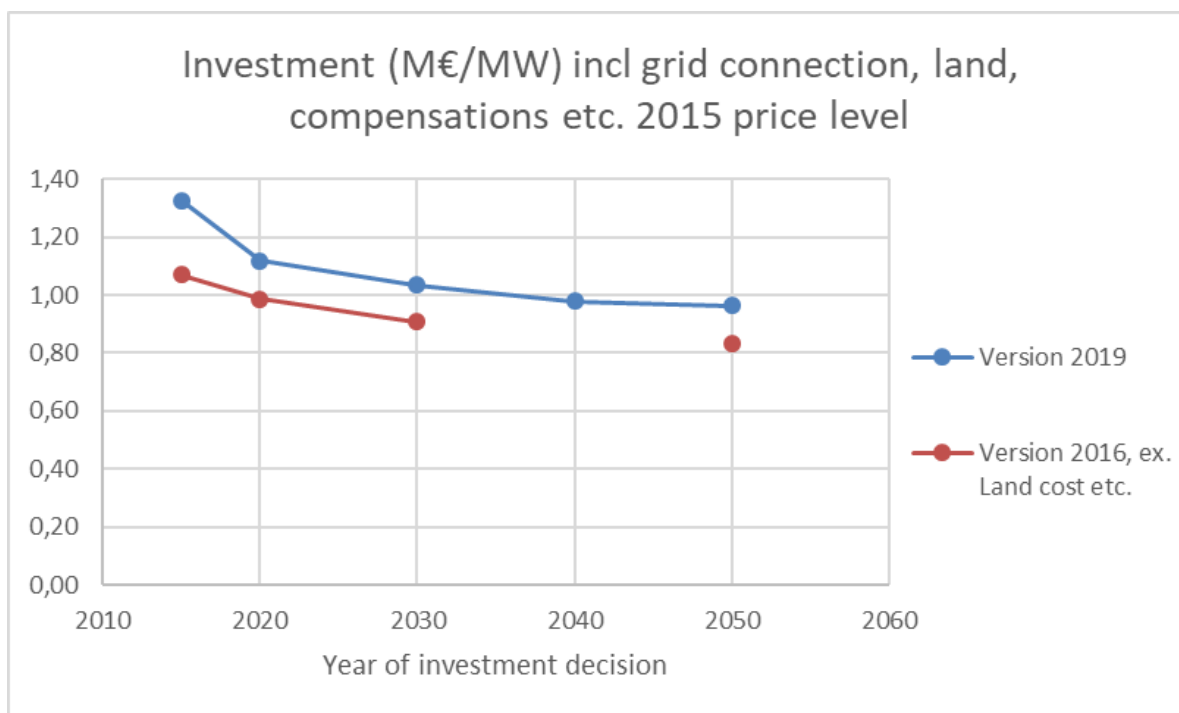

Figure 18 Expected development in investment costs, Ver.2019 inclusion of land and neighbor compensations explains the increase

In Figure 19, the development in expected full load hours and specific power is illustrated. The low number of full load hours in 2015 could among other things potentially be due to an attractive subsidy regime in that period, which could have allowed for less attractive projects to be realized. The estimated full load hours in 2020 and onwards represents the full load hours of the expected average available technology and the average available wind resource. The increase

after 2020 is mainly related to the decrease in specific power and higher hub heights which in January 2019 is limited to a maximum of 150 m total height by regulation. There will roughly be 2% increase by 5 m hub height increase and 1.5% increase by lowering the specific power 10 W/m<sup>2</sup>. The dominating factor is although the location of the project (wind resource), where the surface roughness is dominating the wind resource variations in Denmark. Changing a location from a roughness class 2 to a roughness class 1 location will give roughly 15% increase in FLH.

Although the tip height limitation of 150m is expected removed during 2019, the 2020 projects still are assumed to respect that limit, while the planning work is done based on this limit. Only projects which already has most of the planning process settled, can be assumed decided in 2020.

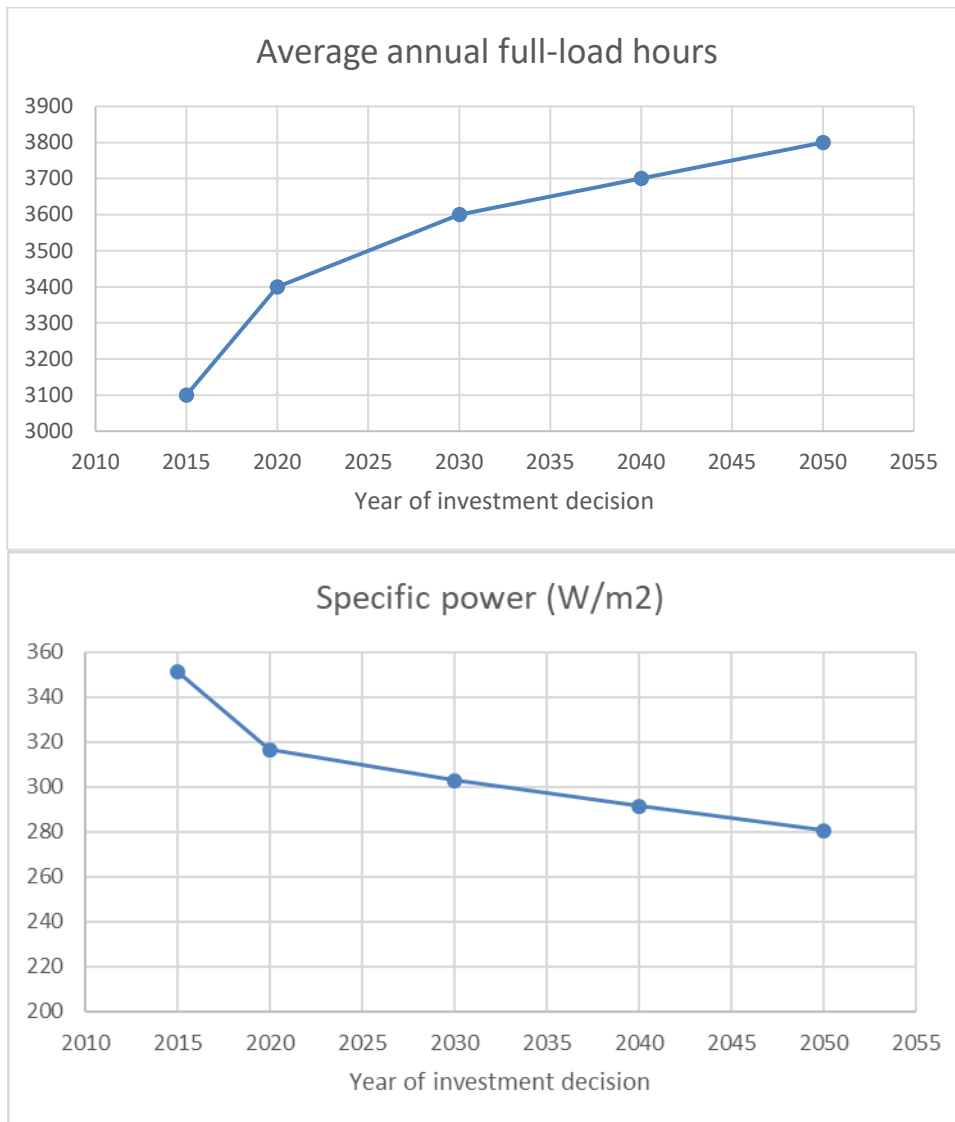

Figure 19 Expected development in production (full load hours (FLH)) and in specific power for on shore wind turbines located in DK.

For the O&M costs, the service agreement is the major part. 70% according to statistics from 12 2017-18 projects. Here a cost reduction of approximately 50% is seen compared to the previous version of the catalogue. This is confirmed by several project developers. Better control of the turbines (less loads), better knowledge on the real costs (more experience means that smaller safe margins are needed as previously) and cheaper spare parts (made in China) are possible reasons for the large cost decrease of round 40% compared to 2016 version of catalogue. The updated O&M cost projections can be seen in Figure 20.

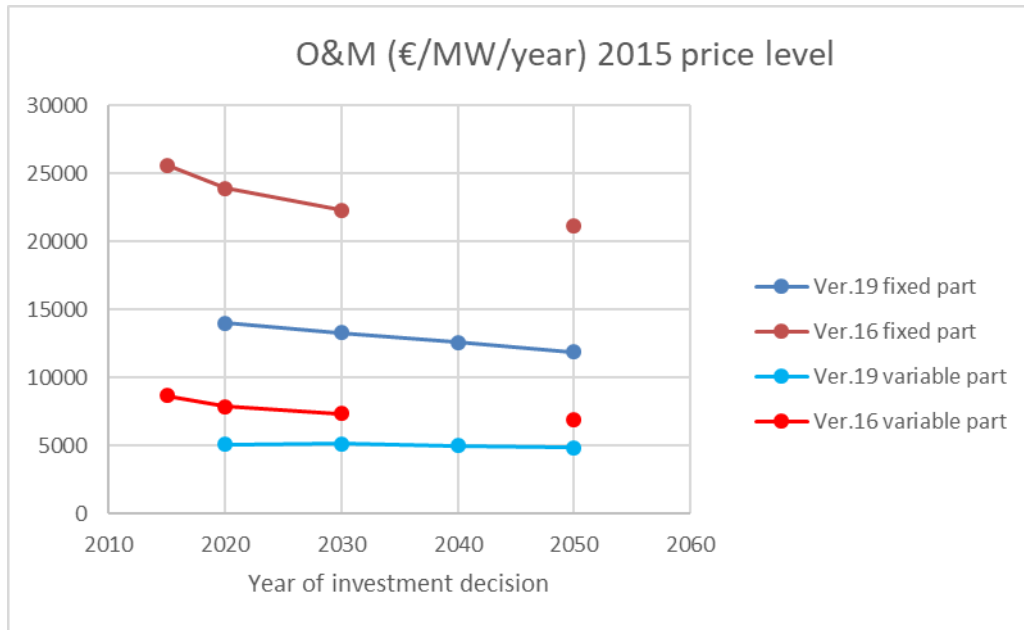

Figure 20 Expected O&M cost, divided into fixed and production dependent (variable, app. 25% of all O&M costs)

Note land lease costs are not included in above, these are assumed part of Capex.

In practice, many wind farms will act in the electricity market with a marginal cost of 0 øre/KWh (thereby assuming no variable O&M). However, in the long run this is not assessed to be a sustainable strategy as some of the moving parts will be worn down with the production and the service fee will scale with production for the service contracts entered later years, at least 5 year back in time. Hence, it is assumed that O&M costs consist of both a fixed and a variable part.

### Uncertainty

As mentioned before the onshore wind technology is quite mature. However, due to improvements in technology and cost reductions, the prediction of future reductions in cost of energy is affected by some uncertainty. Especially it must be noted regarding cost development that many other factors than learning curves can affect the cost development, such as the market situation, costs of rare earth minerals, iron, cobber etc. The development in full load hours is affected by the geographic locations of the majority of the turbines to be installed, and it can be increased considerably if larger total heights will be accepted in the future.

### Future demands, onshore

In the future it could be expected that the onshore wind turbines will be met with

- Higher environmental protection demands like noise or reduced visibility of aviation light marking or less visibility in general (colouring).
- More demands on participation in grid regulation.

### Additional remarks

Recently, the technical lifetime of a wind turbine has been assumed to be 20 years. Recent investigations and real-life experiences indicate longer technical lifetimes [19, 20, 21]. For turbines installed in the coming years lifetimes of 25 years are expected. In the longer term (2030-2050) lifetimes of up to 30 years could be expected.

### Domestic wind turbines (micro wind or small-wind turbines)

Domestic wind turbines are micro-wind or small-wind turbines with a capacity up to 25 kW. According to the regulation in Denmark domestic wind turbines (up to 25 kW) must be located in close proximity of a house (within 20 m from building) [23] and must follow the same demands for noise as large turbines [23].

The capacity factor of small wind turbines varies a lot dependent on the local conditions. The turbines are often located close to buildings and trees, which will reduce the annual production from the turbines. The specific power will as for the larger turbines have an impact on the capacity factor and so have the relative low hub height. An average capacity factor of 18% (approximately 1600 full load hours) is assumed in this study. There are no public available statistics for confirmation of this though, while domestic turbines only report sold power whereas in-house consumption directly from turbine is not registered.



Data sheets

| Technology   | 20 Large wind turbines on land |        |        |        |        |                    |                    |              |              |      |          |
|--|--------------------------------|--------|--------|--------|--------|--------------------|--------------------|--------------|--------------|------|----------|
|  | 2015                           | 2020   | 2030   | 2040   | 2050   | Uncertainty (2020) | Uncertainty (2050) | Note         | Ref          |      |          |
| Year of final investment decision  |                                |        |        |        |        |                    |                    |              |              |      |          |
| <b>Energy/technical data</b>   |                                |        |        |        |        | <b>Lower</b>       | <b>Upper</b>       | <b>Lower</b> | <b>Upper</b> |      |          |
| Generating capacity for one unit (MW)  | 3,1                            | 4,2    | 5      | 5,5    | 6      | 2,0                | 6,0                | 1,5          | 8,0          | A1   | 3        |
| Average annual full-load hours   | 3100                           | 3400   | 3600   | 3700   | 3800   | 2000               | 4000               | 2000         | 4500         | A, L | 3        |
| Forced outage (%)  | 3,0%                           | 2,5%   | 2,0%   | 1,8%   | 1,5%   | 1,0%               | 5,0%               | 1,0%         | 5,0%         | B    | 4        |
| Planned outage (%)   | 0,3%                           | 0,3%   | 0,3%   | 0,3%   | 0,3%   | 0,1%               | 0,5%               | 0,1%         | 0,5%         | C    | 4        |
| Technical lifetime (years)   | 25                             | 27     | 30     | 30     | 30     | 25                 | 35                 | 25           | 40           | D    | 14       |
| Construction time (years)  | 1,5                            | 1,5    | 1,5    | 1,5    | 1,5    | 1                  | 3                  | 1            | 3            | E    | 4        |
| Space requirement (1000m2/MW)  | ---                            | ---    | ---    | ---    | ---    | ---                | ---                | ---          | ---          | F    |          |
| <b>Regulation ability</b>  |                                |        |        |        |        |                    |                    |              |              |      |          |
| Primary regulation (% per 30 seconds)  |                                |        |        |        |        |                    |                    |              |              | G    |          |
| Secondary regulation (% per minute)  |                                |        |        |        |        |                    |                    |              |              | G    |          |
| <b>Financial data (in 2015€)</b>   |                                |        |        |        |        |                    |                    |              |              |      |          |
| Nominal investment (M€/MW)   | 1,33                           | 1,12   | 1,04   | 0,98   | 0,96   | 0,77               | 1,16               | 0,80         | 1,19         |      | 16, 2, 4 |
| - of which equipment   | 0,89                           | 0,71   | 0,64   | 0,59   | 0,58   | 0,57               | 0,86               | 0,46         | 0,69         |      | 25       |
| - of which installation/development  | 0,12                           | 0,09   | 0,08   | 0,08   | 0,07   | 0,07               | 0,11               | 0,06         | 0,09         |      | 25       |
| - of which is related to grid connection                                     | 0,06                           | 0,05   | 0,05   | 0,05   | 0,05   | 0,04               | 0,06               | 0,04         | 0,06         |      | 25       |
| - of which is related to rent of land  | 0,09                           | 0,09   | 0,09   | 0,09   | 0,09   | 0,07               | 0,10               | 0,07         | 0,10         |      | 25       |
| - of which is related to decommissioning of existing turbines                | 0,04                           | 0,04   | 0,04   | 0,04   | 0,04   | 0,03               | 0,04               | 0,03         | 0,04         |      | 25       |
| - of which is related to other costs (i.e. compensation of neighbours, etc.) | 0,13                           | 0,14   | 0,14   | 0,14   | 0,14   | 0,11               | 0,17               | 0,11         | 0,17         | I    | 25,26    |
| Fixed O&M (€/MW/year)  | 25.600                         | 14.000 | 12.600 | 11.592 | 11.340 | 11.200             | 16.800             | 9.072        | 13.608       | I    | 25,26    |
| Variable O&M (€/MWh)   | 2,80                           | 1,50   | 1,35   | 1,24   | 1,22   | 1,20               | 1,80               | 0,97         | 1,46         |      |          |
| <b>Technology specific data</b>  |                                |        |        |        |        |                    |                    |              |              |      |          |
| Rotor diameter   | 106                            | 130    | 145    | 155    | 165    | 90                 | 130                | 100          | 150          | K    | 4, 26    |
| Hub height   | 85                             | 85     | 100    | 105    | 110    | 85                 | 120                | 85           | 150          |      | 4, 26    |
| Specific power (W/m2)  | 351                            | 316    | 303    | 291    | 281    | 314                | 452                | 191          | 453          |      |          |
| Average capacity factor  | 35%                            | 39%    | 41%    | 42%    | 43%    | 23%                | 46%                | 23%          | 51%          |      | 4, 26    |
| Average availability (%)   | 97%                            | 97%    | 98%    | 98%    | 98%    | 99%                | 95%                | 99%          | 95%          |      | 4, 26    |

Notes:

- A The capacity is set to 3.5 MW in 2015 and 2020 based on data of current wind turbines and under the anticipation that the maximum height will not exceed 150m before 2020. From 2030 a slight increase in generator size, and hub height is assumed, where the effect of expected removal of present max. 150m tip height.
- A The full load hours (annual production (MWh) per installed power (MW)) depending on the actual location of the wind farm, wake losses and technological characteristics of the individual turbine. The value is an average for the expected locations of the wind farms. FLH also depends on wake losses, noise reduction and technological characteristics of the individual turbine. The level for 2020 is based on expectations from the November 18 auction winners locations and the 2019 preferred technology choice. For 2030 and 2050 a slight increase is assumed based on decrease in specific power and increase in hub height.
- B Modern turbines has typically higher forced outage than older smaller turbines had when they were newer due to more complex technology.

- C Planned outage is typically 1-2 service visits a year, with a maximum duration of one work day, but there can also be planned outage due to shadow flicker stop or sector management (protect turbines at given wind speeds and directions, where they are dense spaced).
- D The life time depends on the wind conditions; average annual speed and turbulence, relative to the design class of the turbine
- E The construction time is the periode from FID to commissioning. But from first "dig" to turbines are in operation less than ½ a year is needed for smaller wind farms (clusters), where the similar periode for larger wind farms will be longer. The planning time from idea to construction starts will typically be 2-3 years, but can be essentially more if permitting problems occur.
- F An area of around 50 m x 50 m is needed for a modern wind turbine. Another way of defining the "area use" could be the noise zone, which ranges up to 600-800 m from the wind turbine in worst case.
- G Wind turbines can be downward regulated within very short time and can therefore (if the wind is blowing) be used in both the primary and secondary downward regulation.
- H 2015 Investment costs are based on a number of prospects for projects published in relation to Køberetsordningen. 2020 investment costs are based on updated data from Køberetsordningen. Note that the investment costs listed here includes construction loan interests
- I 75 % of the total yearly O&M costs are assumed to be fixed cost and 25 % are assumed to be variable cost.
- K Currently only turbines up to 150 m total height is installed commercially in Denmark because of strict demands to higher turbines. No change in the national regulation is assumed until after 2020. Some test sites allow for larger turbines. Aboard e.g. in Germany turbines with at total higher of 200 m is installed today.
- L It is expected that the production (FLH) increase 13% from 2015 to 2020 and 3% from 2020-2030 and 1% per decade from 2030-2050

| Technology                                 | Small wind turbines, grid connected (< 25 kW) |        |        |        |                    |       |                    |       |      |     |
|--|---|--------|--------|--------|--------------------|-------|--------------------|-------|------|-----|
|  | 2015  | 2020   | 2030   | 2050   | Uncertainty (2020) |       | Uncertainty (2050) |       | Note | Ref |
| Energy/technical data                      |   |        |        |        | Lower              | Upper | Lower              | Upper |      |     |
| Generating capacity for one unit (MW)      | < 0,025                                       |        |        |        | 0,005              | 0,025 | 0,005              | 0,025 |      |     |
| Average annual full-load hours             | 1600  | 1600,0 | 1600,0 | 1600,0 | 1000               | 2300  | 1000               | 2300  | A,J  |     |
| Forced outage (%)                          | 3%  | 3%     | 3%     | 3%     | 2%                 | 10%   | 2%                 | 10%   |      |     |
| Planned outage (%)                         | 0,3%  | 0,3%   | 0,3%   | 0,3%   | 0,1%               | 0,5%  | 0,1%               | 0,5%  | B    |     |
| Technical lifetime (years)                 | 20  | 20     | 20     | 20     | ---                | ---   | ---                | ---   |      |     |
| Construction time (years)                  | 1   | 1      | 1      | 1      | 0,5                | 1,5   | 0,5                | 1,5   |      |     |
| Space requirement (1000m <sup>2</sup> /MW) | 0,8   | 0,8    | 0,8    | 0,8    | ---                | ---   | ---                | ---   | C    |     |
| <b>Regulation ability</b>                  |   |        |        |        |                    |       |                    |       |      |     |
| Primary regulation (% per 30 seconds)      | ---   | ---    | ---    | ---    | ---                | ---   | ---                | ---   | D    |     |
| Secondary regulation (% per minute)        | ---   | ---    | ---    | ---    | ---                | ---   | ---                | ---   | D    |     |
| <b>Financial data</b>                      |   |        |        |        |                    |       |                    |       |      |     |
| Nominal investment (M€/MW)                 | 4,0   | 3,8    | 3,6    | 3,4    | 3,0                | 6,0   | 3,0                | 6,0   | E/F  |     |
| - of which equipment                       | 90%   | 90%    | 90%    | 90%    | 85%                | 95%   | 85%                | 95%   | E/F  |     |
| - of which installation                    | 10%   | 10%    | 10%    | 10%    | 15%                | 5%    | 15%                | 5%    | E/F  |     |
| Fixed O&M (€/MW/year)                      | 100000  | 95000  | 90000  | 85000  | ---                | ---   | ---                | ---   | G    |     |
| Variable O&M (€/MWh)                       | ---   | ---    | ---    | ---    | ---                | ---   | ---                | ---   |      |     |
| <b>Technology specific data</b>            |   |        |        |        |                    |       |                    |       |      |     |
| Rotor diameter                             | 8   | 8      | 8      | 8      | 4                  | 14    | 4                  | 14    | H    |     |
| Hub height                                 | 18  | 18     | 18     | 18     | 14                 | 18    | 14                 | 18    | H    |     |

**Notes:**

- A The annual production is very sensitive to conditions at the actual site. Values outside the range is observed.
- B The maintenance normally consists of 1 -2 annual service visits.
- C An area of around 5 m x 5 m is needed for at small wind turbine. The real "area use" is the noise zone, which ranges up to 100 m from the wind turbine.
- D Not considered relevant for small domestic turbines.
- E Based on information from manufacturers and resellers. The
- F The prices depends significantly on turbine size (5 kW - 6 M€/MW; 10 kW - 4 M€/MW ; 25 kW - 3 M€/MW)
- G The service cost is assumed fixed to 100€/kW/y.
- H Domestic turbines have a maximum total height of 25 m according to Danish regulations.
- J No development in the capacity factor is expected, because no changing in the size limitation (legislation) is expected. And because location is crucial for wind turbines is put up at the best positions already. But change in legislation is discussed including easing in the limit in overall height and allowance to build from the property.

## References

- [6] Information's from expert workshop held by DEA 27-4-2015.
- [7] DTU International Energy Report - Wind Energy, DTU, 2014.
- [8] Master data register of wind turbines at end of December 2014, Danish Energy Agency, 2015.
- [9] Nielsen, P. et. al., Vindmøllers økonomi EUDP projekt 33033-0196, 2010.
- [10] Fixed Speed and Variable-Slip Wind turbines Providing Spinning reserves to the Grid, NREL, 2013.
- [11] Sundhedsundersøgelsen [Online]. Available: <http://vindinfo.dk/sundhedsundersogelse.aspx>.
- [12] M. e. al, Wind Turbines and Health, Journal of Occupational and Environmental Medicine, årg. 56, nr. 11, November 2014.
- [13] Vindkraftens påverkan på fåglar och fladdermöss, Naturvårdsverket, 2011.
- [14] Life Cycle Assessment of Electricity Production from an onshore V112-3.3 MW Wind Plant, June 2014, Vestas Wind Systems A/S.
- [15] Environmental Product Declaration - SWT-3.2-133, [siemens.dk/wind](http://siemens.dk/wind), 2014.
- [16] S. Krohn, The Energy balance of modern turbines, December 1997.
- [17] Karl R. Haapala and Preedanood Prempreeda, Comparative life cycle assessment of 2.0 MW wind turbines, Oregon State University, USA, 2014.
- [18] Increasing the Owner's Value of Wind Power Plants in Energy Systems with Karge
- [19] Information from Energinet.dk based on analyses of resent installed projects (2013-14), published under "Købsretsordningen", 2015.
- [20] Når all-inclusive service alligevel ikke dækker alt, Naturlig Energi, nov. 2014.
- [21] Schwabe, P., Lensink, S. & Hand, M., IEA Wind Task 26: Multi-national case study of the financial cost of wind energy, 2011.
- [22] IEA Wind TCP, Impact of Wind Turbine Technology on the System Value of Wind in Europe, Ea Energy Analyses, November 2017
- [23] Renewable Power Generation Cost in 2017, Irena, 2017.
- [24] Hvor længe holder en mølle, Naturlig Energi, januar 2012.
- [25] Green, Staffell, How does wind farm performance decline with age?, Renewable Energy 66, 2014.
- [26] Vindmøller lever længere end forventet, November 2010. [Online]. Available: <http://www.ing.dk/artikel/vindmoller-lever-laengere-end-forventet-114251>.
- [27] Vejledningsnotat om planlovens regler ved opstilling af husstandsmøller, Naturstyrelsen, 2012.
- [28] Bekendtgørelse om støj fra vindmøller - BEK nr. 1284 af 15-12-2011, Retsinfo, 2011.
- [29] Energiaftalen af 22. marts 2012, <http://www.efkm.dk/energi-forsynings-klimapolitik/dansk-energi-forsynings-klimapolitik/energiaftale>, 2012.
- [30] Minivindmøller i København, Ea Energy Analysis for Copenhagen Municipality, November 2009.
- [31] Analysis of "køberets" projects installed during 2017-18
- [32] Interviews with project developers and suppliers

## 21 Wind Turbines, Offshore

### Contact information:

Danish Energy Agency: Christoph Wolter <[chwo@ens.dk](mailto:chwo@ens.dk)>

Energinet: Peter Erik Jørgensen <[pjr@energinet.dk](mailto:pjr@energinet.dk)>

Author: Per Nielsen (EMD International A/S)

### Publication date

August 2016

### Amendments after publication date

| Date                 | Ref.                                  | Description  |
|----------------------|---------------------------------------|--|
| <b>March 22 (II)</b> | Qualitative description               | Statements about water depth and distance to shore in Table 4 and Table 5 corrected<br>Description of Finance cost in Figure 9 specified |
| <b>March 22</b>      | Qualitative description and datasheet | Technology description revised and updated<br>Updated data sheets for offshore wind turbines and nearshore wind turbines                 |
| <b>September 19</b>  | Datasheet                             | Financial data (2050) and space requirements of nearshore wind datasheet corrected   |
| <b>May 19</b>        | Qualitative description and datasheet | Financial and technical data updated in data sheets<br>Description of Floating foundations<br>Environment chapter extended               |
| <b>June 17</b>       | Qualitative description and datasheet | Financial data (Investment cost and O&M) updated   |

This chapter contains data sheets and qualitative descriptions for Offshore and Nearshore projects. Within the text and graphs, focus is on Offshore projects. While there is no common definition of Nearshore projects, in this context Nearshore projects are located close to the coastline and are not equipped with an offshore substation. Historic projects as Nysted, which are very close to shore with an offshore substation, would in this context be considered as Offshore projects. Cables from Nearshore projects are directly connected to onshore substations and therefore Nearshore projects tend to be less expensive. Due to possible environmental or social impact, Nearshore projects could have limitations regarding the turbine size, which for those projects is not assumed to increase as much as for Offshore projects in this context.

#### Note to Amendment March 2022:

Offshore wind technology development is foreseen to continue to decrease prices, but technology choice can have an effect on technoeconomic parameters, such as specific power effect of turbines, as well as geographical considerations with offshore wind farms being located further from shore. This amendment has focussed on describing and quantifying

those factors in the data sheet in higher detail than in previous editions of the chapter. An additional Annex describing predictions of performance in cost in more detail supplements this version of the chapter.

*Note to Amendment May 2019:*

The trend seen in the 2017 amendment were seen to continue. The reasons are as described in 2017 amendment. The costs have decreased further illustrated by the bid winning prices:

|                      | øre/kWh | MW    | MW/WTG |
|----------------------|---------|-------|--------|
| HR3 - installed 2018 | 77      | 406,7 | 8,3    |
| VH (Vesterhav)       | 47,5    | 344,4 | 8,4    |
| KF (Krigers Flak)    | 37,2    | 604,8 | 8,4    |

The large decrease is based on several factors, e.g. increased competition, low interest rates and investor WACC's (lower perceived risks due to maturation of technology), development of new and larger turbines as well as larger wind farms. The WTGs purchased for the two new projects has been negotiated as one delivery, which make the purchase order more than twice as large as for HR3.

The updated costs for offshore wind farms are mainly based on costs informed by Vattenfall, partly on their home page, partly supported by interviews. Also OPEX cost has been updated based on interviews.

*Note to Amendments June 2017:*

The winning price in the tenders for the offshore wind farms in Denmark has decreased substantially from 2012 to 2016. The same trend has been seen in e.g. the Netherlands and Great Britain. The reduction in prices is substantially larger than what can be explained by the cost reduction predicted (in the Technology Catalogue). Therefore, the financial data for offshore wind has been updated (June 2017). Changes are made in the sections "*Prediction of costs in 2015*" and in the datasheet.

The update comprises investment costs (CAPEX) and operating & maintenance costs (OPEX), i.e. financial parameters. In terms of data for the more technical parameters such as turbine size, full load hours, lifetime and the like existing data are still considered valid.

There are several reasons for the reduction in the winning bids. The costs of the wind turbine technology itself, as well as for installation, operation and maintenance have fallen sharply in recent years. In general, more experience has been gained in this area, making the collaboration between the different players on the market more efficient. Moreover, there are better opportunities for optimizing project plans and the volume of the offshore wind market. In addition, interest rates are low and technological and economic risks are assessed lower by investors, therefore low returns are accepted and competition has been increasing. Expectations for the electricity price after expiry of the grant period and other possible income from e.g. certificates of origin also affect the bid price.

## Qualitative description

### Brief technology description

For a detailed technical description, see the previous chapter on wind turbines, onshore.

The basic operating principles of offshore wind turbines are the same as for onshore turbines, although modifications are required to make the turbines suitable for deployment offshore. The corrosive offshore environment resulting from the high levels of salt and moisture in the air leads to additional requirements for electrical and mechanical components. Since the world's first offshore wind project at Vindeby in Denmark, many offshore turbines have been equipped with air conditioning systems to protect the sensitive electronics inside the units, and with North Sea-grade protective paint to protect the external steel structures.

Foundations for offshore turbines are subject to more complex load conditions than onshore foundations and the design and concept of offshore foundations are therefore very different from onshore foundations. They must be designed to survive the harsh marine environment and the impact of large waves and ice. These factors and the cost of installation necessitate that they are more expensive than onshore foundations for turbines of similar size.

Until now, offshore wind farms have been installed on four different types of foundation: monopile, gravity, jacket, and tripod structures. Today, monopiles and jackets are the most common foundation types and are still under development. The choice of which foundation type to use depends on the local sea-bed conditions and the water depth. Nowadays, fixed bottom foundations are investigated to be deployed up to 70m with the latest technology.

Suction bucket foundations have been investigated for different applications. Suction bucket foundations are mainly suitable when the seabed is sand but may have the advantage of lower decommissioning cost as well as of noiseless installation compared to monopiles, but there is limited experience in deployment, and consequentially bigger risk. Suction buckets can be used as "anchors" for jacket foundations at large water depths, where the suction effect is easier to attain due to the higher water pressure on the buckets.

Technological innovations such as floating substructures may have the potential to reduce the overall cost in the future. Floating substructures can be designed to be well-suited for large serial production, and they are the only solution for deep waters, in which monopiles and jackets come to their limits.

Offshore wind farms are typically built with large turbines in considerable numbers. The most recent offshore wind farms developed in Denmark have capacities of 800-1000 MW as agreed in the Energy agreement from 2018. The latest concluded Danish tender is Thor, for which RWE from Germany obtained the rights to develop the project further. This will be followed by Hesselø that is expected to have 1000 MW of capacity plus up to 200 MW capacity behind the meter for potential storage or Power to X applications. The Danish parliament agreed in 2021 on further capacities of 2 GW with the aim of being erected before 2030. With the energy hubs (energy islands) in the North Sea and Baltic Sea being added onto this, expectedly supplying both Denmark and neighbouring countries with power, the groundwork towards a more integrated supply system offshore is being laid. In UK, Netherlands and German waters, offshore wind farms of several thousand MW are being developed currently.

Nowadays, offshore wind turbines have built-in transformers delivering 66 kV to the array cable system in the wind farm as a standard size. Solutions of 132 kV are being investigated. The higher voltage level will reduce specific cable costs and losses and the total lifecycle costs and thereby reduce the cost of energy. In traditional offshore wind farms, the array cables are connected to a transformer station in the wind farm. Here, the voltage is transformed to 150 kV, 220 kV or 320 kV for export to the onshore grid. With higher capacities further offshore, HVDC solutions are becoming increasingly important. In Nearshore wind farms, the array cables are connected to an onshore transformer station.

The offshore wind resource increases with increased distance to the shore (Figure 1) and as a result wind farms far from shore will generally have higher capacity factors than Nearshore wind farms. However, due to the simplified grid arrangement with no offshore substation as well as shallow waters and shorter distances to service hubs, Nearshore wind farms have lower cost levels for both investment and O&M.

The wind resource map of Denmark in Figure 1 shows annual average wind speeds for 100 m height of 9.6-10 m/s in the Horns rev area, around 9–9.5 m/s in areas around Rødsand, Anholt and Kriegers Flak. Due to the low surface roughness, the variation in wind speed with height is small for offshore locations; the increase in wind speed from 50 m to 100 m

height is around 8 pct., for comparison the increase in wind speed from 50 m to 100 m height is around 20 pct. for typical inland locations.

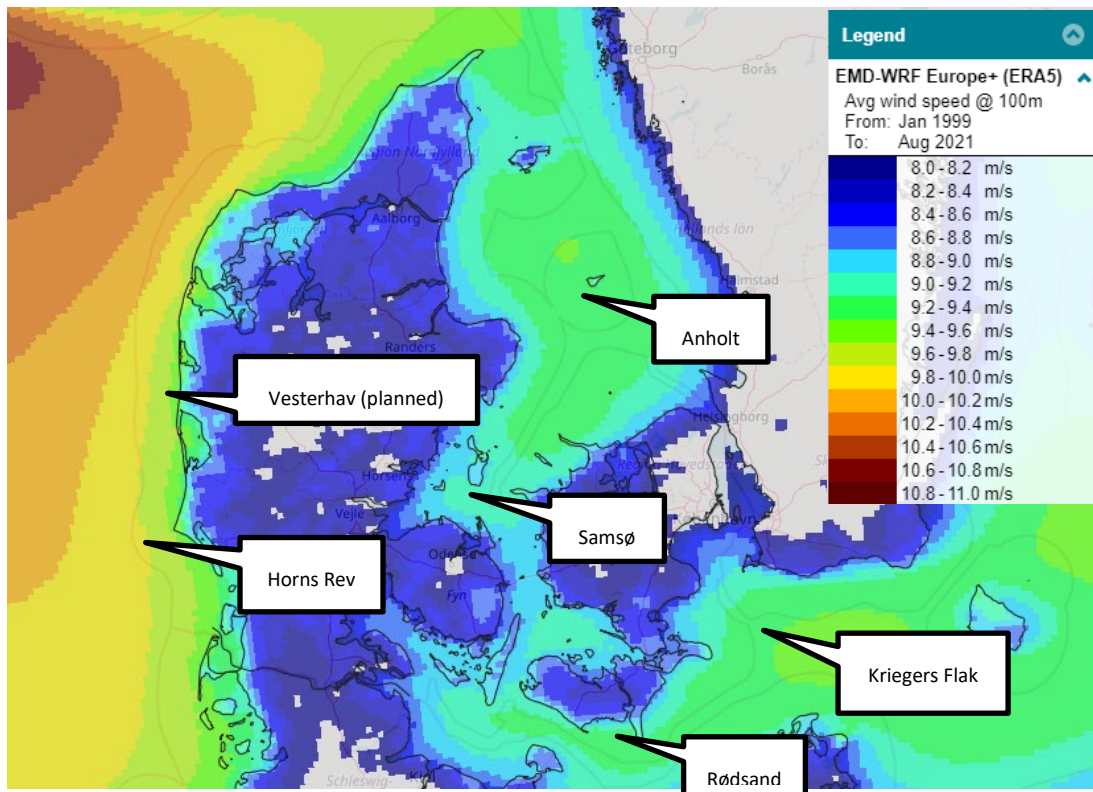

Figure 1 The most recent meso scale model wind data set from EMD International for 100m a.s.l. (above sea level) [1]

For comparison, in Table 1 below the values for the major DK offshore areas are shown for Global Wind Atlas (GWA):

Table 1 Comparison of mean wind speed by source for selected offshore locations.

| Mean wind speed 100m a.s.l. (m/s) | GWA  | EMDWrf <sup>12</sup> |
|-----------------------------------|------|----------------------|
| Horns Rev (2-3)                   | 10   | 9.9                  |
| Anholt                            | 9.6  | 9.4                  |
| Rødsand                           | 9.6  | 9.3                  |
| Kriegers flak                     | 9.7  | 9.4                  |
| Thor                              | 10.2 | 10.0                 |
| Energy Island, North Sea          | 10.3 | 10.1                 |
| Energy Island, Bornholm           | 9.5  | 9.4                  |

There is a reasonably well agreement between the two sources: GWA and EMDWrf. However, GWA predicts slightly higher wind speeds than EMDWrf data for all locations. Based on detailed validation studies [21], the EMDWrf data predicts AEP (Annual Energy Production) for the offshore wind farms quite well. For the most detailed validation cases, it is seen that the EMDWrf wind speed data must be reduced with 2.5 pct. for Horns Rev area to get exact match

<sup>12</sup> Wrf is the short name of the calculation model used for mapping all climate parameters like wind speeds hour by hour based on as well physical models as input data from meteorological measurements.



between calculations and measurements (loss corrected). For onshore and offshore at Anholt and Rødsand, it is seen that 3.5 pct. must be deducted from the wind speed, see graph Figure 2. For the DK offshore locations, there is not assumed to be a need for costly and time delaying offshore wind measurements any longer.

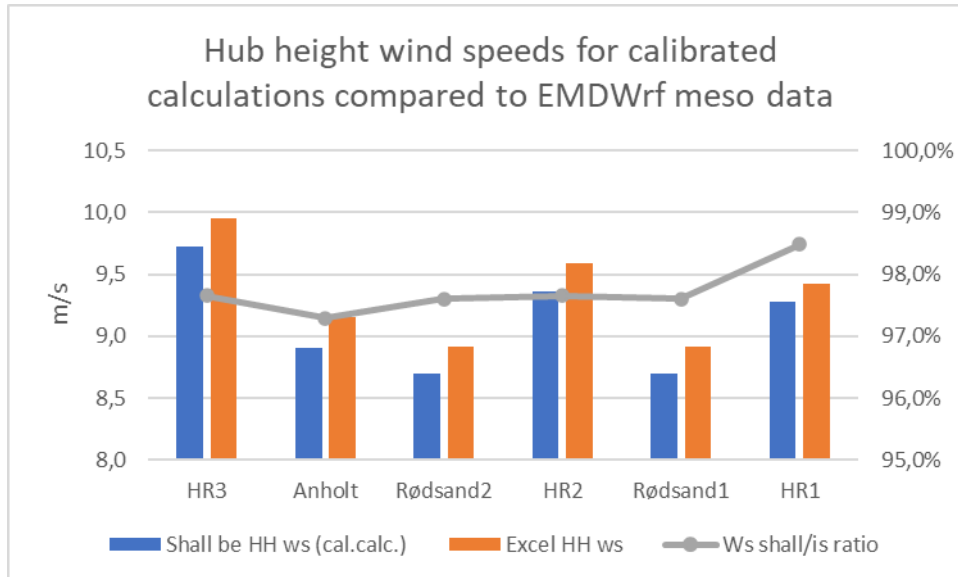

Figure 2 Hub height (HH) wind speeds.

Figure 2 shows that EMDWrf meso wind speed (Excel HH ws) is around 2 pct. higher than the model calibration results indicate, which is accounted for in the techno-economic assumptions given in the datasheet of this chapter. The correction also compensates for the wind distribution Weibull k factor, which in base calculations are assumed to be  $k = 2$ , where DK offshore projects has  $k = 2.4$ . This increases production by 5-6 pct. A total correction of 2 pct. is used to compensate for these two issues.

### Input

Input is wind.

Minimum wind speed: 3-5 m/s, also named “cut in” wind speed.

Rated power generation reached around 12 m/s wind speed.

Cut-out or transition to reduced power operation at wind speed: 25-30 m/s.

Most turbine manufacturers apply a soft cut-out for high wind speeds (indicated with dashed red curve in Figure 3) resulting in a final cut-out wind speed around 30 m/s [2, 3].

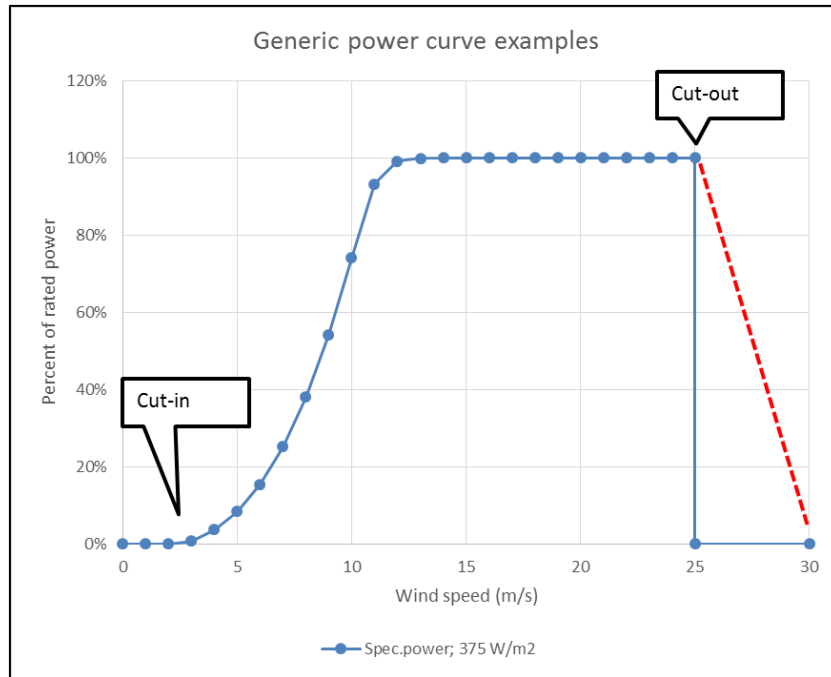

Figure 3 Power curve example [3]. Specific power values refer to e.g. 7 MW with 154 m rotor diameter.

### Output

The output is electricity.

Modern commissioned offshore turbines located in Denmark have capacity factors of the order of 50 pct., corresponding to 4400 annual full load hours. A typical duration curve for a wind farm in the North Sea is presented in Figure 4 below.

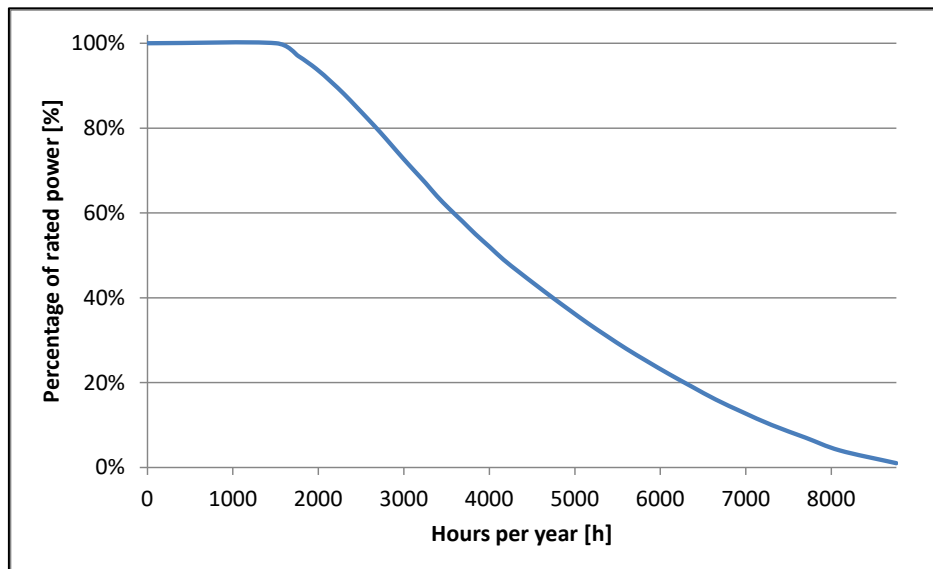

Figure 4 Example of a duration curve for a North Sea offshore wind farm [4]

Typical capacities

The historic growth rate of turbine capacities by their first year of commercial installation on a given site has followed an exponential trend from 2000-2020 with a doubling time of ca. 8-9 years, as indicated in Figure 5. The latest turbine generations in the 14-15 MW range will extend this trend in the next years. At the same time, one might expect a decreasing long-term growth rate as the industry further matures and consolidates possibly through standardization of equipment and components. Market competition might play a role in at what time and thus at which capacity level a stronger standardization will take place.

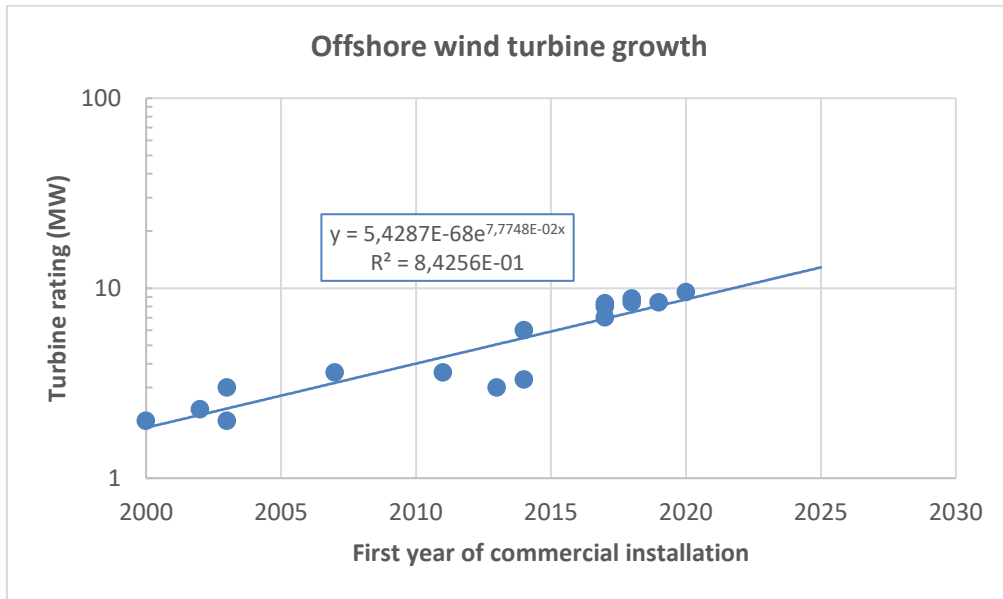

Figure 5 Growth rate for commissioned offshore wind turbines (first year of commercial installation of a given turbine). [5]

It is assumed that the historic and current growth rate will sustain up until 2030. This results in 20 MW turbines in this year, whereafter the growth rate is assumed to decrease, possibly towards a plateau in the future. With current technology, rotor diameters of 300 m are deemed feasible by the industry [22]. With a constant average specific power of 350 W/m<sup>2</sup>, this results in generator capacities of ca. 25 MW and thereby exceeding the extrapolated capacity level in 2030. It is expected that technology improvements will lead to a further increase in capacity [23], however at a slower pace and with slower growth rate.

In consequence, the turbine sizes are assumed to increase to the following capacities shown in Table 2.

Table 2 Assumptions for WTG size for future representative projects

| Year | Assumed WTG size for future projects (MW) |
|------|---|
| 2025 | 15  |
| 2030 | 20  |
| 2040 | 25  |
| 2050 | 30  |

Wind resource and capacity factors

One of the major drivers for developing wind farms offshore rather than onshore is the better wind resource, which can justify some of the additional investment and O&M costs. Figure 6 show long term corrected (LTC) capacity factors for five large offshore wind farms (>150 MW) and two smaller offshore wind farms located nearshore in Denmark. For comparison is shown the average capacity factor for onshore turbines installed 2000-02 and 2011-13 based on measured 2014 performance (which was a normal wind year) [6]. Year of commissioning shown in graph.

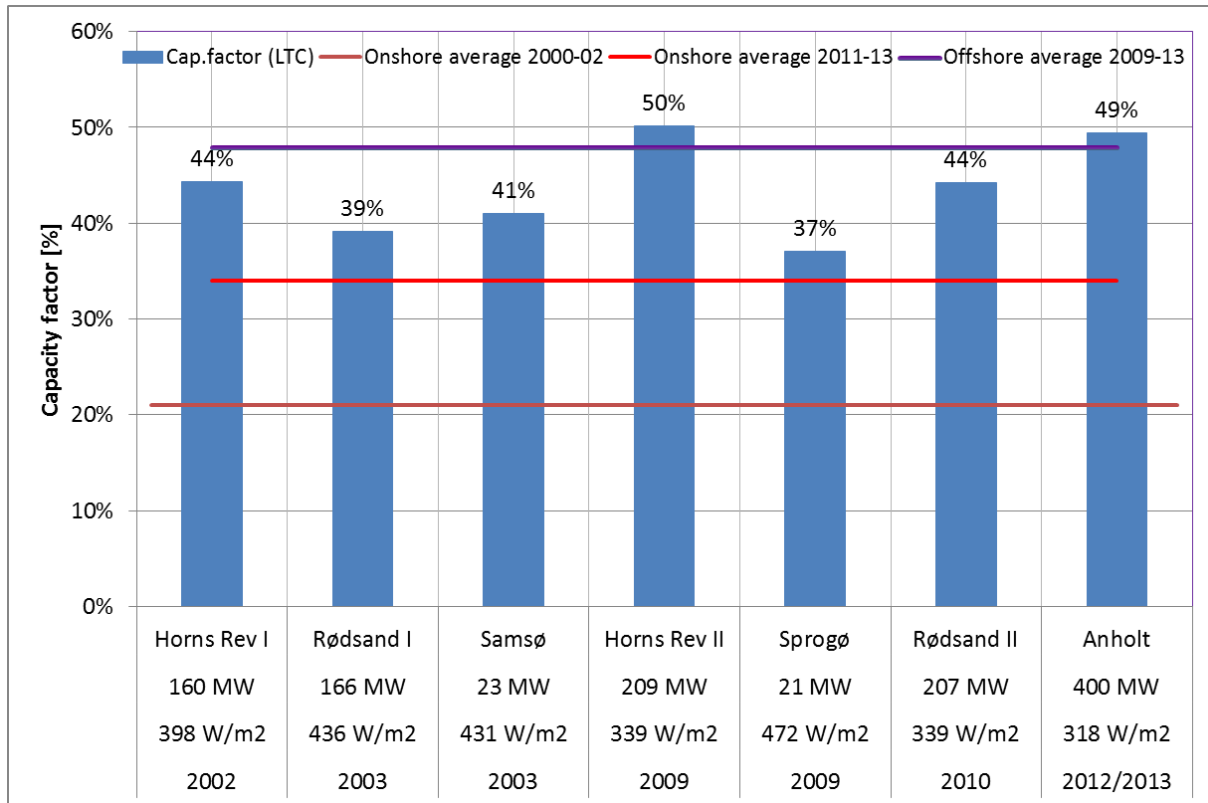

Figure 6 Long term corrected (LTC) capacity factors for offshore wind farms.

Offshore wind farms installed in Denmark 2009-13 have a weighted average capacity factor of 48 pct. As seen in the figure. For comparison, onshore wind turbines installed in Denmark 2011-13 have an average capacity factor of 33 pct.

There is a significant variation in capacity factors between the different projects. This is caused by a combination of differences in the turbine technologies, including different specific power values, and in the wind resources.

It should be noted that the shown capacity factors in the graph above is based on a year where operation has been smooth. For most of the wind farms, there has been longer outage problems mainly due to grid issues, which bring the real long-term capacity factor down with a few percent points.

For Horns Rev 3 a capacity factor slightly above 50 pct. is expected. This is similar to Horns Rev 2, but with a specific power of 393 W/m<sup>2</sup>, which is 15 pct. higher than for Horns Rev 2, it expresses an increase in production per m<sup>2</sup> rotor area due to the larger hub height.

As seen in Table 3, the expectations are fulfilled on average and realized production is within +/- 10 pct. of expectation values per project. No wind energy index corrections are used here. It should be noted that the measured production figures include reductions due to participation in marked regulations and for some projects, especially Horns Rev 1 & 2,

Rødsand 1 (Nysted) and Anholt, there has been outage for several months due to grid problems during some of the farms’ lifetimes. For some projects, the developer expectations are set quite low (HR 2 & 3) for unknown reasons.

**Table 3 Realized production in all operating years expect first year incl. 2020. [6]**

| WindFarm    | Data years | No of WTGs | kW/WTG | Farm size (MW) | Avg. realized MWh/WTG/y | FLH   | Realized cap. f (%) | Expected by developer (MWh/y) | MWh/y/WTG | Measured /expected | Expected Cap. Factor |
|-------------|------------|------------|--------|----------------|-------------------------|-------|---------------------|-------------------------------|-----------|--------------------|----------------------|
| Tunø        | 24         | 10         | 500    | 5              | 1.365                   | 2.729 | 31%                 | 12.500                        | 1.250     | 1,09               | 29%                  |
| Middelgrund | 20         | 20         | 2.000  | 40             | 4.523                   | 2.261 | 26%                 | 93.660                        | 4.683     | 0,97               | 27%                  |
| Horns Rev 1 | 18         | 80         | 2.000  | 160            | 7.031                   | 3.515 | 40%                 | 600.000                       | 7.500     | 0,94               | 43%                  |
| Rødsand 1   | 17         | 72         | 2.300  | 166            | 7.475                   | 3.250 | 37%                 | 596.000                       | 8.278     | 0,90               | 41%                  |
| Samsø       | 17         | 10         | 2.300  | 23             | 8.097                   | 3.520 | 40%                 | 77.650                        | 7.765     | 1,04               | 39%                  |
| GreatBelt   | 11         | 7          | 3.000  | 21             | 8.549                   | 2.850 | 33%                 | 66.000                        | 9.429     | 0,91               | 36%                  |
| Horns Rev 2 | 11         | 91         | 2.300  | 209            | 9.686                   | 4.211 | 48%                 | 800.000                       | 8.791     | 1,10               | 44%                  |
| Rødsand 2   | 10         | 90         | 2.300  | 207            | 8.873                   | 3.858 | 44%                 | 800.000                       | 8.889     | 1,00               | 44%                  |
| Anholt      | 8          | 111        | 3.600  | 400            | 15.294                  | 4.248 | 48%                 | 1.800.000                     | 16.216    | 0,94               | 51%                  |
| Horns Rev 3 | 1          | 49         | 8.300  | 407            | 36.981                  | 4.456 | 51%                 | 1.700.000                     | 34.694    | 1,07               | 48%                  |
| Total       | 137        | 540        | 3032   | 1637           |                         | 3.490 | 40%                 | 6.545.810                     |           | 1,00               | 40%                  |

Figure 7 shows the capacity factor as a function of the specific power with locations represented by colouring. Both the location and the specific power are key drivers of the capacity factor. Horns Rev I and Horns Rev II have a similar wind resource due to the farms’ proximity to each other, but different specific power and therefore result in different capacity factors. Likewise, Rødsand I and Rødsand II have similar wind resource, but different specific power and therefore different capacity factors. The newest installed turbines from Siemens Gamesa (8.4 MW) and MHI Vestas (8.3 MW) have specific power of 383 W/m<sup>2</sup> and 393 W/m<sup>2</sup> respectively, as those models have gotten a generator boost while still being equipped with the same rotor blades. The upcoming 15 MW turbines are so far designed again with lower specific power, but these might be changed and increased by potential generator boosts before serial manufacturing.

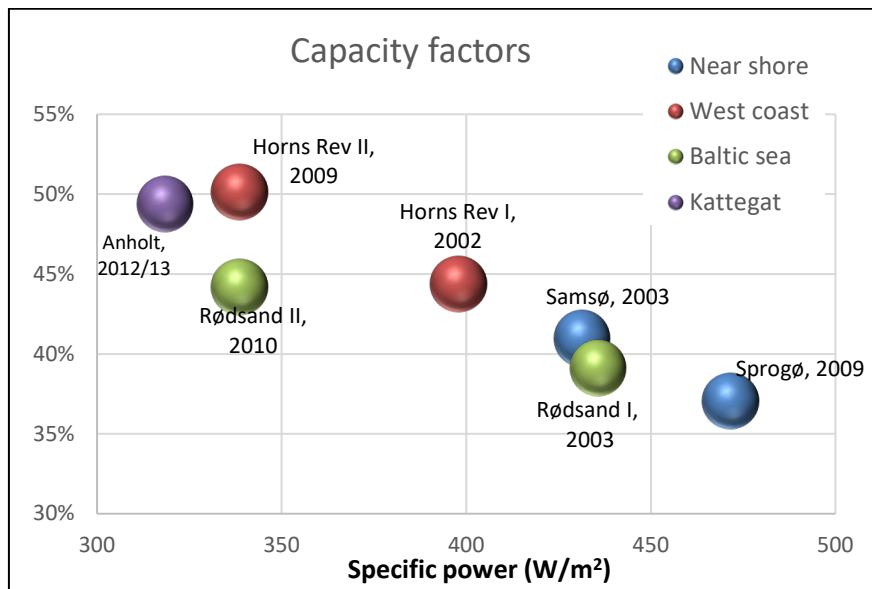

**Figure 7 Capacity Factor shown as function of the Specific Power (W/m<sup>2</sup>) for Danish Offshore wind turbine projects. The three projects most left are the latest ones among the sample. (Figure from previous version of Technology Catalogue, not updated from table above).**

### Regulation abilities and power system services

Offshore wind turbines have similar regulation and ancillary service capabilities to onshore turbines. See the descriptions in the chapter “Wind turbines onshore”.

Because of the large distances between the wind farm and the point of connection to the power grid, the regulation of voltage and reactive power in the main power grid is more challenging for offshore wind farms than for their onshore counterparts. A larger distance will result in an increased impedance and loss. An offshore wind farm will be able to compensate for reactive power created by itself; however, their contribution to further compensation of reactive power in the main power grid is limited and depends on the distance to point of connection. Onshore wind turbines, which in general are closer to the grid, have better possibilities for contributing to regulation of voltage and reactive power. Due to the difference in sizes between typical offshore and onshore wind farms, respectively, the potential for regulation abilities however is bigger for offshore wind farms than onshore wind farms.

### Advantages/disadvantages

Offshore wind turbines have similar general advantages and disadvantages to onshore turbines. See the chapter “Wind turbines onshore”.

The major advantages of offshore wind turbines, relative to onshore wind turbines, are the better wind resources offshore, the reduction of the visual and noise impacts from turbines which has become a major barrier for onshore deployment, and the possibility of building much larger wind farms than onshore.

There are, however, more logistical considerations associated with building wind turbines offshore than onshore and needs for more expensive equipment, resulting in higher capital costs for offshore wind farms. Those costs, however, can pay off when considering the bigger scale of the projects and better wind resource.

Electricity from offshore wind production has the potential to become an export product, as Denmark has relatively more space for offshore development than most European countries compared to its own energy consumption.

### Environment

Some disturbance to sea-life must be anticipated during the construction phase for offshore wind turbines.

Before, during, and after the construction of the two Danish wind farms Horns Rev I and Rødsand I, comprehensive monitoring programmes were launched to investigate and document the environmental impact of these two wind farms [7]. The monitoring programmes showed that, under the right conditions, large wind farms pose low risks to birds, mammals and fish. Species diversity even tends to increase due to the increase in habitat heterogeneity resulting from the foundations, which act as miniature reefs.

Consequently, the results from the monitoring programmes demonstrate that it is possible to establish offshore wind farms in a way, which is environmentally sustainable, and which causes negligible damage to the marine environment. Environmental investigations on the most recent project in Denmark (Kriegers Flak) also showed low to moderate impact on the wildlife in the area.

For Nearshore projects, it is seen that the relative proximity of the wind farms to the coast has an influence on the response from people living in the vicinity. For the Vesterhav projects, this was reflected in the demand for compensation from around 600 summerhouse owners.

### Research and development perspectives

Besides the R&D potential described in the chapter “Wind turbines onshore”, offshore technology development is expected to include [8, 9].

- Further upscaling of wind turbines,
- New foundation types suitable for genuine industrialization, among which floating substructures,

- Development of higher electrical wind farm systems of 132 kV and up as alternative to present 66 kV,
- Development of compact offshore substations, including high-voltage direct current (HVDC) converter stations and cables. HVDC equipment is available today, but only assumed economically feasible at more than ~100km to shore,
- Multi terminal HVDC with power flow in both directions to integrate large quantities of offshore wind power in a future meshed offshore grid
- Improvement of design methods in planning and operation phase, e.g., reduction of wake losses, O&M costs by e.g. improved control strategies, more optimized tower/foundation structure by integrated design,
- Logistic issues, e.g. more dedicated vessels in installation and maintenance phase,
- Improved methods for handling of different seabed conditions, lowering foundation costs,
- Improved reliability and fault tolerance, among others due to monitoring, in operational phase for lowering availability losses and securing optimal operation.

Currently, the pace of product development and competition is high. Consequently, projects are often planned and developed with turbines that are not yet in serial production.

### Examples of best available technology

The latest major offshore wind farm installed in Denmark is Kriegers Flak wind farm. It consists of 72 Siemens-Gamesa turbines, each with 8.4 MW capacity, resulting in a total installed capacity of 605 MW. The wind turbine has 167 m rotor diameter, leading to a specific power of 383 W/m<sup>2</sup>. This turbine size although already must be assumed outdated for future projects.

For Hollandse Kust Zuid 1-4 in the Netherlands, Vattenfall are now constructing 1.5 GW wind farm based on 11 MW Siemens turbines with 200 m rotor diameter. For the next project Northfolk at UK east coast to be commissioned in 2027, Vattenfall expect 15 MW Siemens with 236 m rotor diameter. This is a project with an expected 3.6 GW to be installed.

At Testcenter Østerild, Siemens has established a 15 MW with 236 m rotor diameter.

Vestas has announced a 15 MW with 236 m rotor diameter to be established at Østerild in Q4 2022.

### Performance and cost development

New in this 2022 update of the Technology Catalogue is a more refined prediction of future costs. Also, LCOE (Levelized Cost of Energy) is calculated. In previous versions and in most other publications the learning rate theory has been dominating for future cost predictions as an “all in one” learning rate.

In the following, a more refined approach is used. Future projects are designed based on:

- Expectations of future larger WTG sizes, which is assumed to increase to 30 MW in 2050.
- Expectations of future longer distances to shore and deeper water depths, which are larger the longer the outlook with most suited sites taken first.
- Expectations of larger projects (measured in installed MW) which decrease project development costs per MW.

There are further dependencies to offshore wind farm design than what has been possible in the scope of this work. All calculations are deemed overall representative on a system level, which the Technology Catalogue aims to express. Individual project characteristics can result in other dependencies and cost breakdown variations than what is presented in the following.

Cost functions for each part of the wind farms have been developed, taking the impact of factors like WTG and farm size, water depth and distance to shore into consideration. E.g. the larger WTGs will be, the taller the turbine tower will be and thereby the costs pr. MW increases, but also the production pr. MW increases due to the swept area being able to harness higher wind speeds in higher atmospheric layers. Another factor is that by lower rotational speed for larger turbines, the torque on the main shaft increases more than the rated power. Installation costs is what is expected to decrease most pr. MW, while costs do not double when the size doubles. It takes roughly the same time to install a bigger turbine, but a larger vessel is needed.

The cost functions are developed by EMD based partly on data, partly physics. NREL has been a large inspiration as they have worked with this topic for many years and made several publications, but also DTU has delivered valuable input [10,11,12].

On top of the cost functions, traditional learning rates will be applied, but now subdivided on different type of equipment and installations. This is known as multi-factor learning curve and uses a bottom-up approach to predict future cost developments. E.g. for cable equipment, there is used fixed costs per meter cable in spite of much higher power with increased turbine size, which then indirect includes cost reductions by size of turbines/wind farms. Therefore very little or no learning rate improvements can be expected as such, in this case raw material costs will be much more deciding.

Future raw material costs changes have, however, not been taken into account (apart from nominal price changes through inflation).

A more detailed description of the cost functions can be found in a separate Annex to the chapter in the background material on the Technology Catalogue homepage.

The following wind farms are configured representing the years presented in the Technology Catalogue:

### Assumptions for offshore wind projects

Table 4 presents the main geographical and technical design specifics for the assumed representative offshore wind projects in the given years.

For 2020, the project is specified close to the characteristics of Kriegers Flak. Noticeably, turbine size as well as distance to shore and water depth is increased during the period. This would increase costs pr. MW in time, not considering any learning, which is accounted for separately and mentioned further down in the methodological description. The increased turbine size will lower the wake losses, even with larger wind farm size when a constant spacing in rotor diameters (RD) is used. The specific power is assumed to be close to 350 W/m<sup>2</sup> for future turbines.

For wake losses there are not assumed reductions due to neighbouring wind farms. This will be relevant if more large projects are constructed in near vicinity, like seen in German Bugt and some locations in UK, like Irish sea. Experience from these sites indicates that up to 5 pct. losses could be added, but very much dependent on distances and sizes.



Table 4 Project specifications for offshore wind.

| Future Offshore projects                   |                      |       |      |      |      |      |
|--|----------------------|-------|------|------|------|------|
| Project parameter                          | Output unit          | 2020  | 2025 | 2030 | 2040 | 2050 |
| Water depth                                | [m]                  | 25    | 27   | 30   | 35   | 35   |
| Distance to shore                          | [km]                 | 25    | 27   | 30   | 40   | 50   |
| Number of WTGs                             | [-]                  | 72    | 54   | 50   | 50   | 50   |
| WTG size                                   | [MW]                 | 8.4   | 15   | 20   | 25   | 30   |
| Farm size                                  | [MW]                 | 605   | 810  | 1000 | 1250 | 1500 |
| Rotor Diameter                             | [m]                  | 167   | 236  | 270  | 300  | 330  |
| Specific Power                             | [W/m <sup>2</sup> ]  | 383   | 343  | 349  | 354  | 351  |
| Hub height                                 | [m]                  | 103.5 | 138  | 155  | 170  | 185  |
| Mean wind speed at 100 m a.s.l.            | [m/s]                | 10    | 10   | 10   | 10   | 10   |
| Mean wind speed at hub height (calculated) | [m/s]                | 10.0  | 10.4 | 10.5 | 10.6 | 10.7 |
| Mean turbine spacing                       | RD (rotor diameters) | 8     | 8    | 8    | 8    | 8    |
| Lifetime                                   | Years                | 27    | 30   | 30   | 30   | 30   |
| Wake loss (calculated)                     | %                    | 7.2%  | 5.7% | 5.2% | 4.9% | 4.7% |

### Assumptions for Nearshore wind projects

Table 5 presents the main geographical and technical design specifics for the assumed representative Nearshore projects in the given years.

For Nearshore wind farms, smaller projects are assumed with 20 WTGs and a WTG size that does not exceed 15 MW. The reason for this is that visual impact is assumed to be too problematic with very large WTGs. This assumption requires that smaller turbines will still be available while the offshore market is expected to announce even bigger turbines going forward. Historically, there has not been a distinction between available “Offshore” and “Nearshore” turbines, but there has only been once certain generations of turbines (with a given size) available on the market.

The mean wind speed is set to 9 m/s 100m a.s.l. for Nearshore projects, for which offshore substations are not considered as part of the project development. Water depth is for all years set to 15 m and distance to shore to 10 km. The wake losses are here assumed fixed at 2.5 pct, as Nearshore projects are expected typically just to be established in a single-row layout with fewer losses than what can be expected in a generic square layout. The distance is considered to be at 4 RD (Rotor Diameters).

Table 5 Project specifications for Nearshore wind.

| Future Nearshore projects                  |                      |       |       |      |      |      |
|--|----------------------|-------|-------|------|------|------|
| Project parameter                          | Output unit          | 2020  | 2025  | 2030 | 2040 | 2050 |
| Water depth                                | [m]                  | 15    | 15    | 15   | 15   | 15   |
| Distance to shore                          | [km]                 | 10    | 10    | 10   | 10   | 10   |
| Number of WTGs                             | [-]                  | 20    | 20    | 20   | 20   | 20   |
| WTG size                                   | [MW]                 | 8.4   | 10    | 15   | 15   | 15   |
| Farm size                                  | [MW]                 | 168   | 200   | 300  | 300  | 300  |
| Rotor Diameter                             | [m]                  | 167   | 191   | 236  | 236  | 236  |
| Specific Power                             | [W/m <sup>2</sup> ]  | 383   | 349   | 343  | 343  | 343  |
| Hub height                                 | [m]                  | 103.5 | 115.5 | 138  | 138  | 138  |
| Mean wind speed at 100 m a.s.l.            | [m/s]                | 9     | 9     | 9    | 9    | 9    |
| Mean wind speed at hub height (calculated) | [m/s]                | 9.0   | 9.1   | 9.3  | 9.3  | 9.3  |
| Mean turbine spacing                       | RD (rotor diameters) | 4     | 4     | 4    | 4    | 4    |
| Lifetime                                   | Years                | 27    | 30    | 30   | 30   | 30   |
| Wake loss (estimated)                      | %                    | 2.5%  | 2.5%  | 2.5% | 2.5% | 2.5% |

Worth remembering when predicting future costs is the historical development illustrated below (Figure 8).

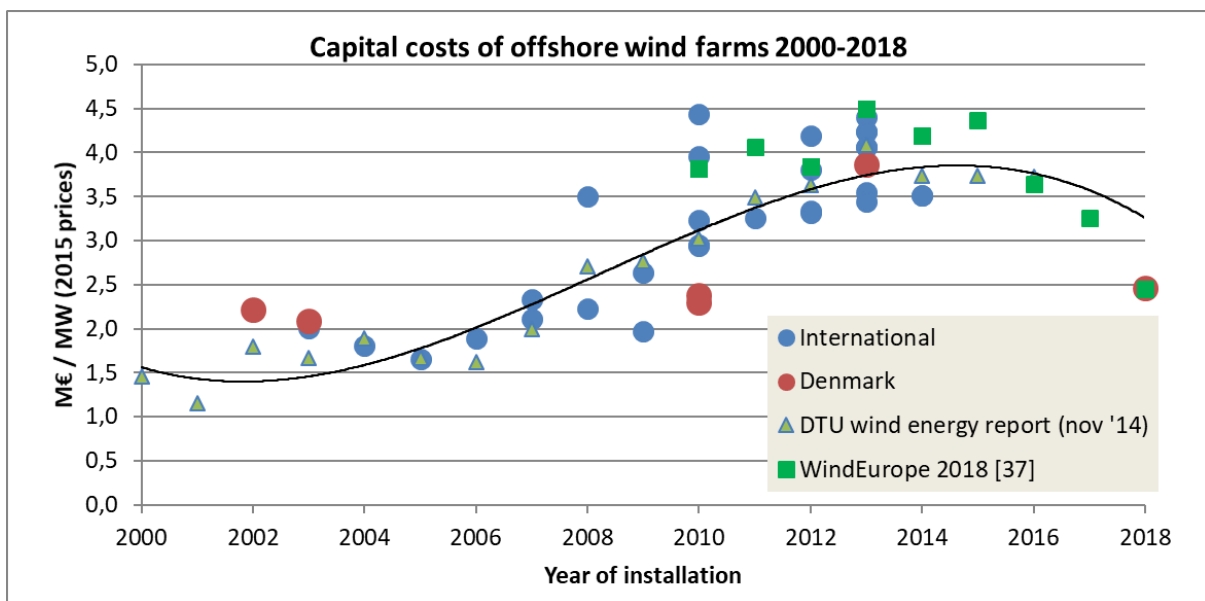
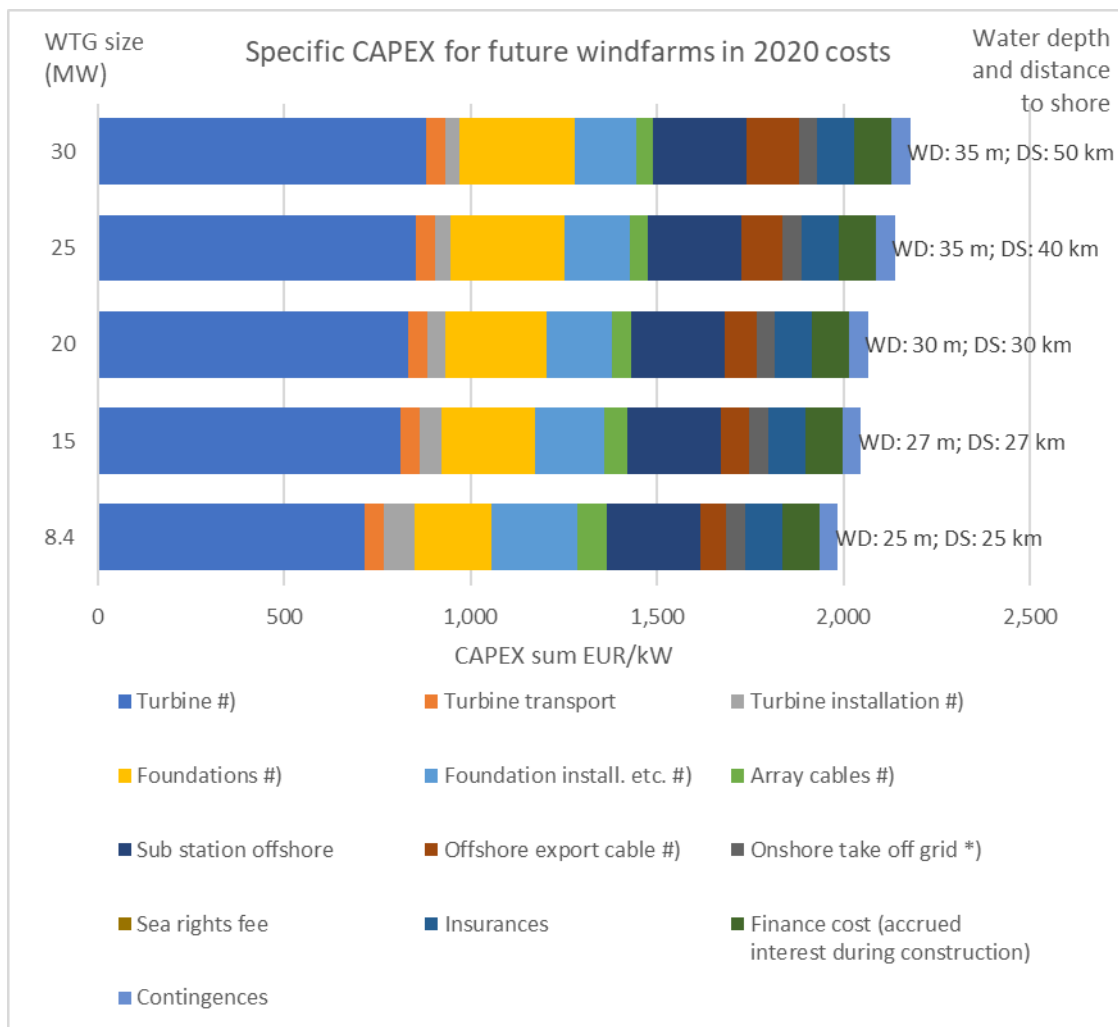

Figure 8 Capex development historical based on data from [13].

Figure 8 is taken over from the previous version of the Technology Catalogue chapter for offshore wind. As apparent from the pattern of specific costs over time, no learning rate theory could predict this specific development. There will always be a risk that other factors than learning will primarily drive cost development. There are many explanations for the heavy cost increase in 2005-15. A new industry was built putting pressure on the supply chain. Many new companies entered the industry and bottlenecks in supply as well as lack of experience were driving costs up. High subsidies especially for the many UK projects made it possible to set the costs high. Furthermore, geographic characteristics as developing sites in deeper waters and further from shore are not reflected by the specific cost metric as shown in the figure, as well as differences between HVAC and HVDC connections and various regulations in the different countries developing offshore wind. The first projects before 2005 were primarily based on “pioneer work” where the focus had been on making the projects successful and keep costs low.

**Cost breakdown based on cost functions**

A cost breakdown of the representative offshore wind sites based on the above defined characteristics is presented in the following Figure 9.



**Figure 9 Detailed cost breakdown for future wind farms without learning rates.**

It is worth noting about what is shown in Figure 9 that the increase in equipment costs increase partly due to WTG size, but also because of increasing water depth and distance to shore. These are almost balanced off by decreased

installation costs due to the higher turbine size and thereby a lower number of turbines and foundations per capacity. Markers in legend text: #) Based on formula expression \*) Very site specific.

With the developed cost functions as described in the Annex to the chapter, sensitivities on different parameters can be calculated. Here, based on 2020 assumptions, the water depth and distance to shore is evaluated (Figure 10). As seen, both are linear. Doubling the water depth from 25 m to 50 m increases Capex with 12 pct. and LCOE with 8 pct.. Doubling distance to shore from 25 km to 50 km increases Capex with 4 pct. and LCOE with 2 pct. The model does not assume that Opex will change by varying the two parameters, even though there can be dependencies for real projects due to weather windows and time spent on maintenance, among other circumstances. On the one hand it could be argued that longer distance to shore would increase Opex, but on the other hand it could be expected that projects with longer distances to shore will be larger as well and thereby some savings pr. MW would be seen that are not accounted for in this perspective either. These factors are therefore assumed to level off each other.

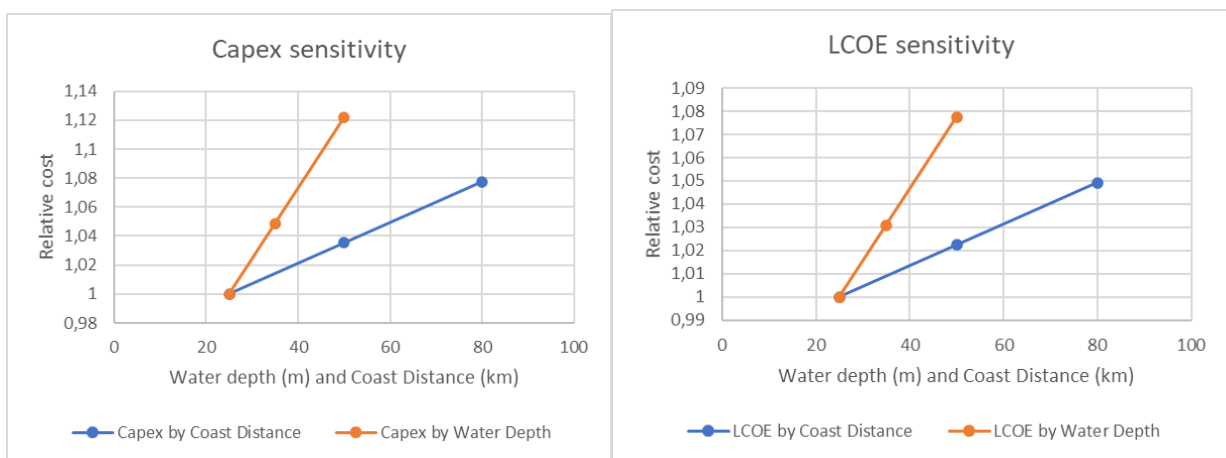

Figure 10 Sensitivities to water depth and distance to shore (left: sensitivity on Capex; right: sensitivity on LCOE).

Figure 11 shows cost breakdown for 2020 project configuration aggregated as in data sheets.

Figure 12 shows a simpler presentation of development with project specifications where the cost impact through varying turbine and site characteristics is plotted.

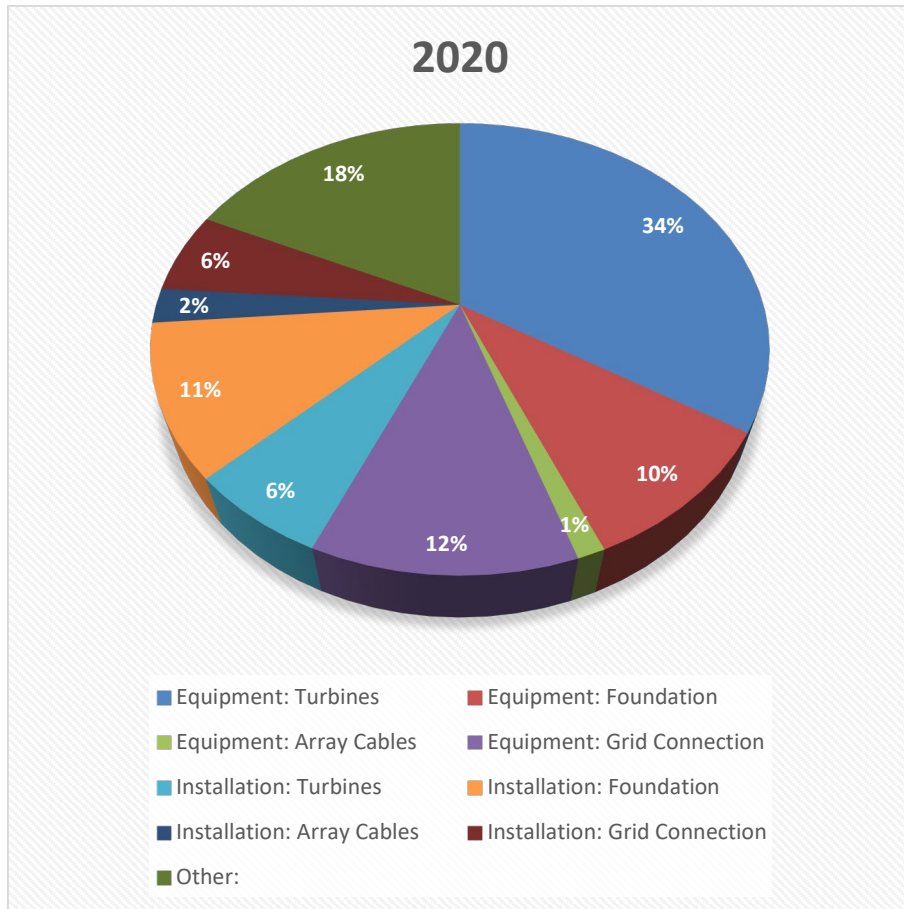

Figure 11 Simpler cost breakdown with Equipment and installation separated by type based on cost function.

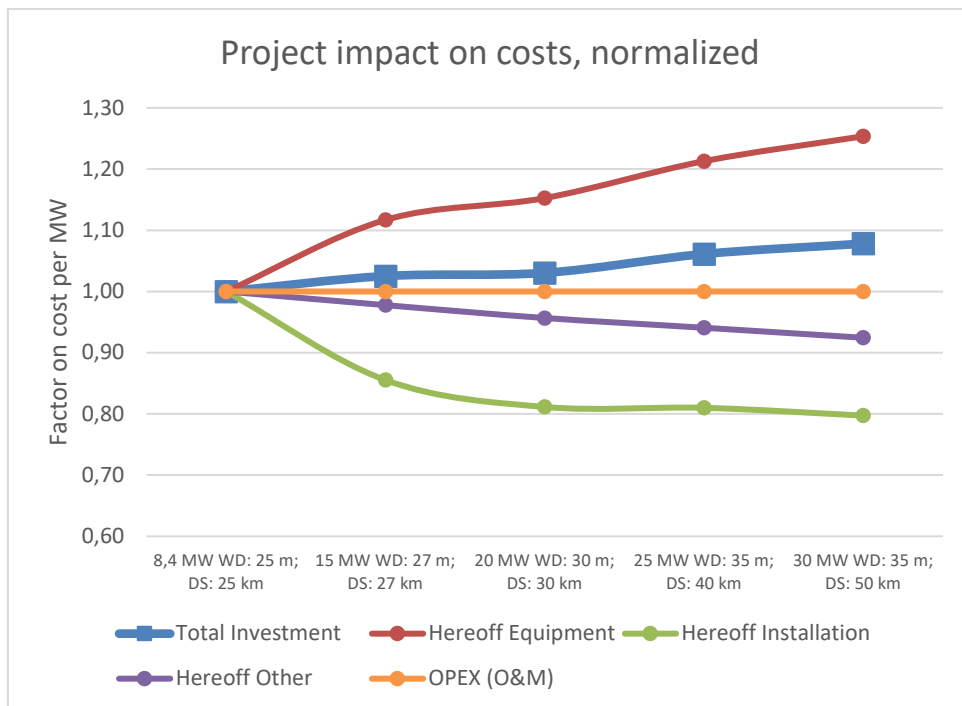

Figure 12 Project design impact on costs (without learning).

The equipment costs are expected to increase 25 pct. due to WTG size increase, increased water depth and distance to shore. On the other hand, a drop in installation costs leaves the total investment cost roughly at an increase of 8 pct. for the configuration with largest turbine size, water depth and distance to shore. What is not shown in the figure is that the energy production is assumingly higher, partly due to increased hub height and thereby wind speed, but also less wake loss due to the larger WTG size.

Next, learning cost reductions are included. The specific learning rates assumed for the different components used for the future cost expectations are listed in Table 6 below.

**Table 6 Learning rate assumptions by component.**

| Cost component                            | Learning rate | Comments on learning rates                        |
|---|---------------|---|
| <b>Capex</b>                              |               |   |
| Equipment: Turbines                       | 7%            | Non fully mature technology                       |
| Equipment: Foundation                     | 7%            | Non fully mature technology                       |
| Equipment: Array Cables                   | 2%            | Mature technology, further improvement expected*) |
| Equipment: Export cables & substations    | 2%            | Mature technology, further improvement expected*) |
| Installation: Turbines                    | 7%            | Non fully mature technology                       |
| Installation: Foundation                  | 7%            | Non fully mature technology                       |
| Installation: Array Cables                | 4%            | Rather mature technology                          |
| Installation: Export cables & substations | 4%            | Rather mature technology                          |
| <b>Opex</b>                               |               |   |
| Fixed O&M                                 | 8%            | Largest potential seen                            |
| Variable O&M                              | 8%            | Largest potential seen                            |

\*) In cost calculations a fixed cost per m cable is used – this thereby already assumes an essential cost reduction while the cables transport essentially more energy due to larger turbines and project sizes in time.

IEA[19] expects a learning rate of 15 pct., meaning every time the global installed offshore wind capacity is doubled, the cost is reduced with 15 pct. NREL [18] assumes a learning rate of 8-16 pct. (scenarios). IRENA [14] presents a learning rate of 9 pct. measured on the sole impact on costs. These learning rate assumptions seem very optimistic, partly due to:

- A. In their starting point (2020) Capex and Opex is ~45 pct. higher than for DK offshore costs based on Kriegers Flak costs,
- B. The installation cost decrease much by size and must be assumed a part of the learning expectations,
- C. The Danish projects have already gained much learning with most projects developed by just two developers. As such, it is doubtful how much added learning will come for Danish projects based on massive new offshore development in e.g. China,
- D. Wind turbines have a very high content of raw materials, like steel etc. This will give a “base cost” that cannot be affected by learning, in slight contrast to products like photovoltaic (PV), where the raw material content is comparably smaller.

Table 6 above, which shows the estimated learning rates, results in a weighted learning rate of 7 pct. On top of this learning rate, the other economy of scale effects (project impact) such as the increase in WTG and farm size must be considered as well. Cost increases due to deeper sea levels and longer distance to shore are likewise held separate in the estimations.

**Expected annual added capacity**

The expected global annual offshore wind capacity addition is the other assumption needed for establishing the learning rate effects. The assumed additions are shown in Figure 13 below.

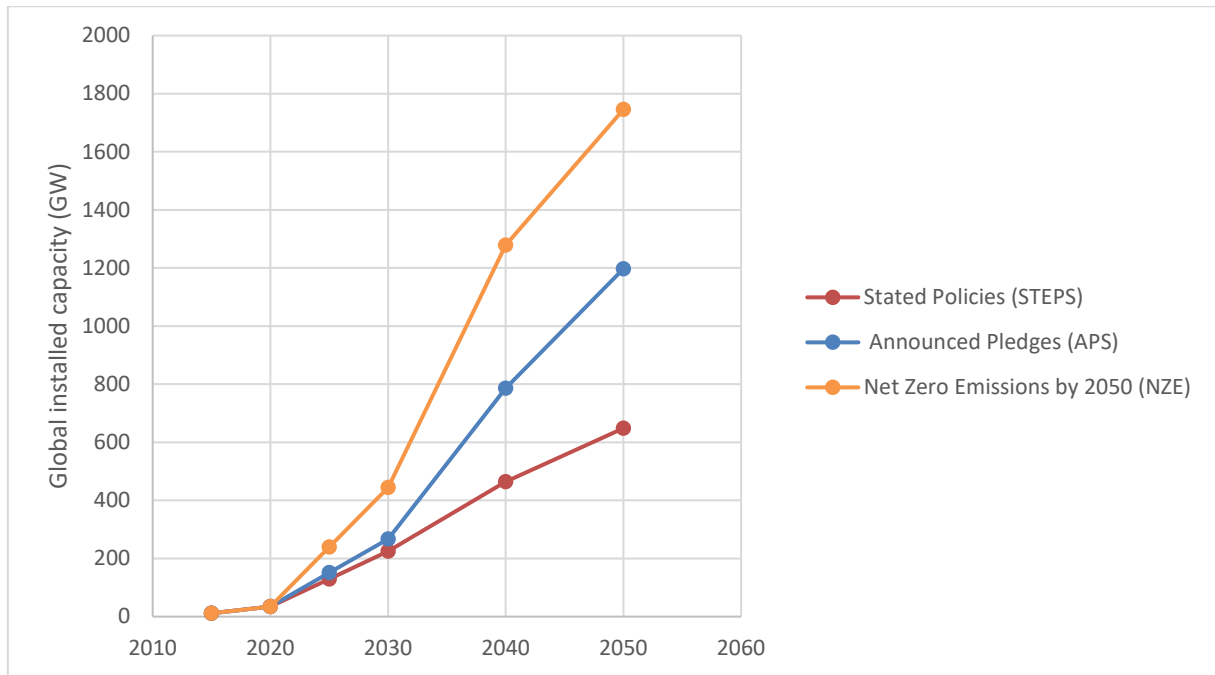

**Figure 13 IEA assumptions on global additions of offshore wind capacity.**

Using the IEA central estimate Announced Pledges, the multiple compared to 2020 level of installed capacity will be according to the numbers in Table 7:

**Table 7 Factors on 2020 accumulated installation (33.5 GW).**

|  | 2020 | 2025  | 2030  | 2040  | 2050   |
|--|------|-------|-------|-------|--------|
| Accumulated capacity [GW]                    | 33.5 | 150.9 | 267.3 | 785.9 | 1197.2 |
| Multiple compared to 2020 installation level | 1    | 4.5   | 8.0   | 23.5  | 35.7   |

These multiples are used in the learning rate formula, which states that doubling the amount (here accumulated installed global capacity offshore wind) results in a cost decrease by the specified learning rate (LR) factor:

$$Learning\ factor = Factor^{(\ln(1-LR)/\ln(2))}$$

Where the LR used is seen in Table 6 above.

The resulting learning factors can be seen in Figure 14 below.

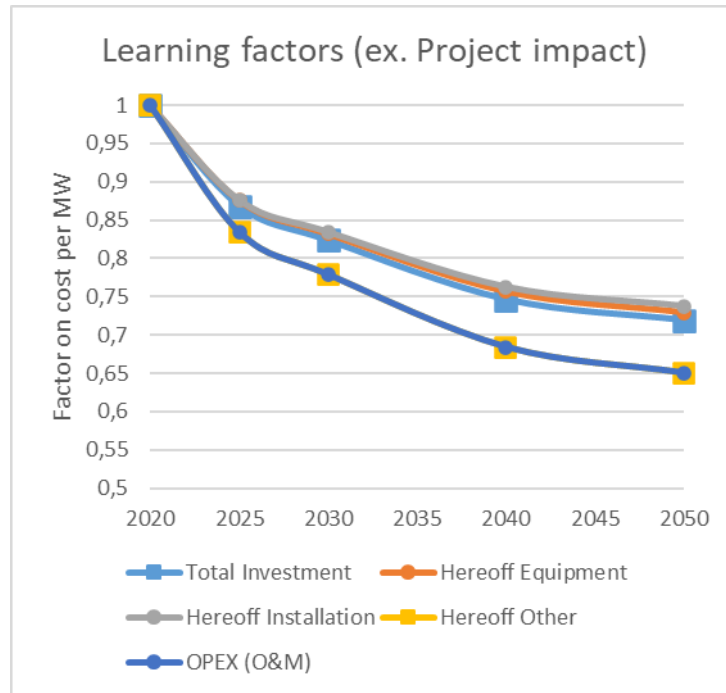

Figure 14 Learning rate-based cost reduction factors. The impact of project size by cost functions not included.

Combining the project design cost factors with learning rate-based results in the projections shown in Figure 15 below.

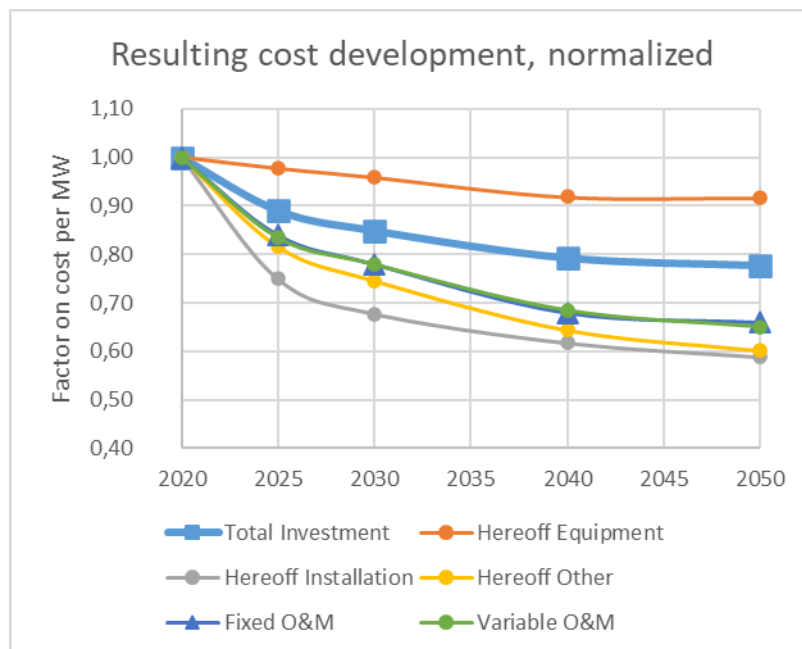

Figure 15 Resulting cost reductions for offshore wind in Denmark.

Comparisons to NREL’s “Annual Technology Baseline” [18] and IEA’s World Energy Model [19] are depicted in the following graphs (figure 39-41), where NREL data corresponds to the background line, the combined EMD cost function and learning is presented by the blue dots and IEA data is presented by the orange triangles.



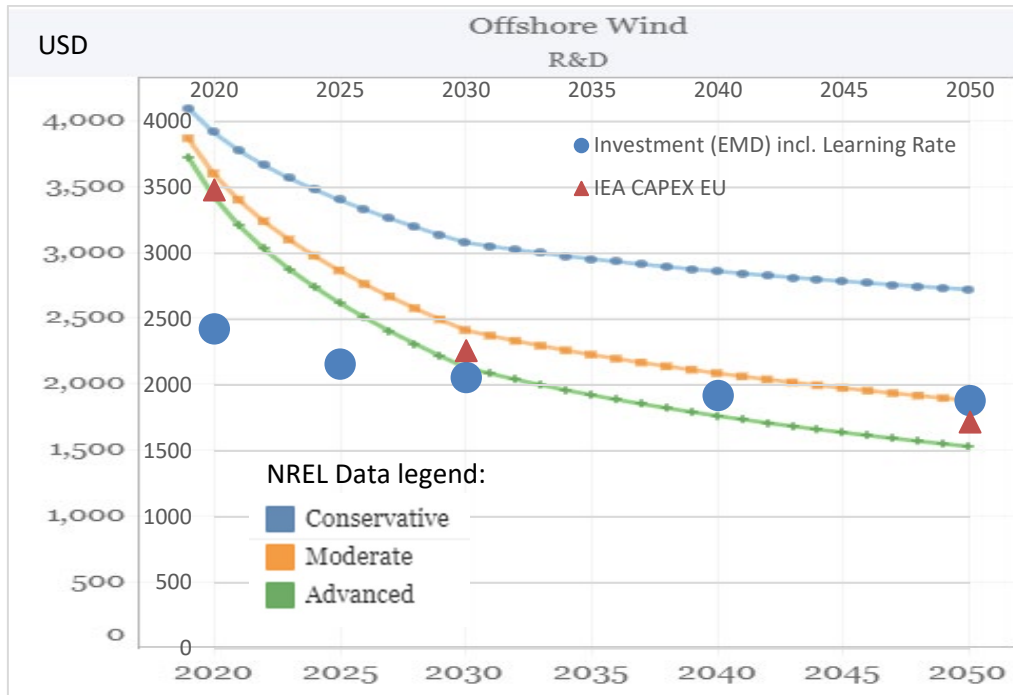

Figure 16 Capex comparisons in USD/kW, NREL data as background.

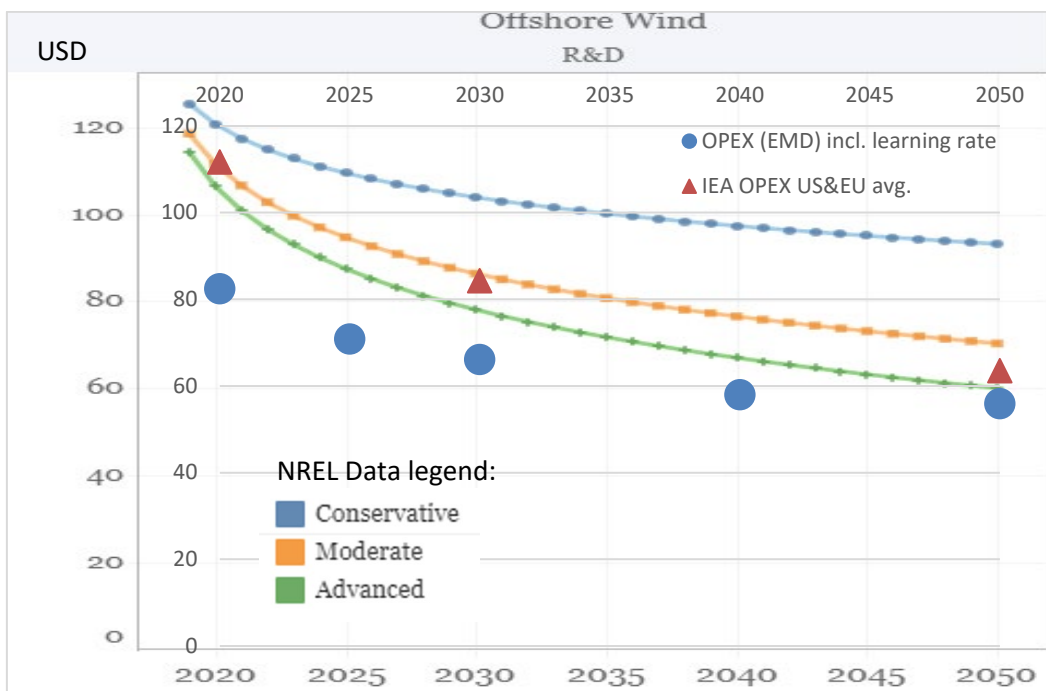

Figure 17 Opex comparisons in USD/kW/y, NREL data as background.

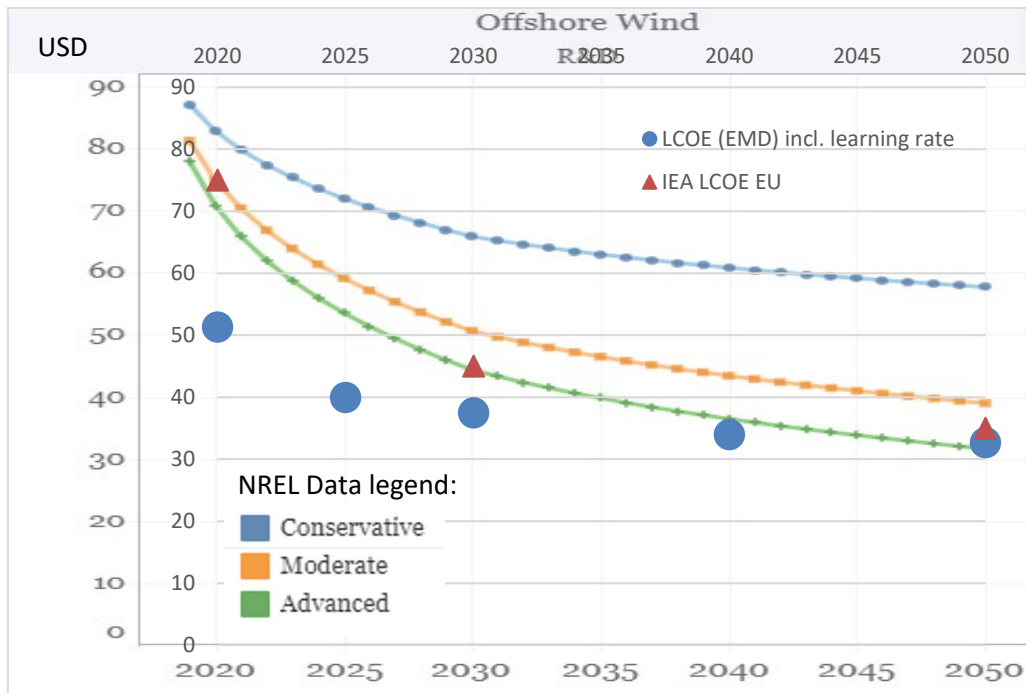

Figure 18 LCOE comparisons in USD/MWh, NREL data as background.

It is seen that the DK-Technology cost data is lower in the first years compared to the other data sources. But due to lower learning rates for the DK-Technology data, in combination with the cost changes due to the specific project impact, over time, NREL advanced, IEA and DK-Technology ends up with almost similar cost levels.

The IEA data for Opex are taken as an average of USA and EU costs. It seems the two data lines in IEA table are not fully correct, but taking the average gives meaningful values.

For LCOE it is important which AEP is assumed. The assumed capacity factors can be seen in Table 8 below.

Table 8 Assumed capacity factors by source.

|             | 2020 | 2030 | 2050 |
|-------------|------|------|------|
| EMD         | 50%  | 55%  | 57%  |
| IEA-EU [19] | 51%  | 55%  | 58%  |
| NREL [18]   | 45%  | 47%  | 48%  |

EMD capacity factors are based on real project calculations, with base assumption of 10 m/s in 100 m a.s.l. The reason for higher capacity factors by years are the larger turbines, partly giving higher hub heights and thereby higher wind speeds, partly lower wake losses due to fewer turbines. For Nearshore projects, the base wind speed is assumed to be 9 m/s at 100m a.s.l. Here, wake losses are assumed to be 2.5 pct. (just one row perpendicular to main wind direction), and the capacity factors becomes 47 pct., 50 pct., 50 pct. for the three years above.

### Prediction of LCOE based on performance and costs

The LCOE is calculated by discounting AEP and costs with a 3.5 pct. discount rate and uses the shown lifetime assumptions in Table 4. The results are displayed in Figure 19.

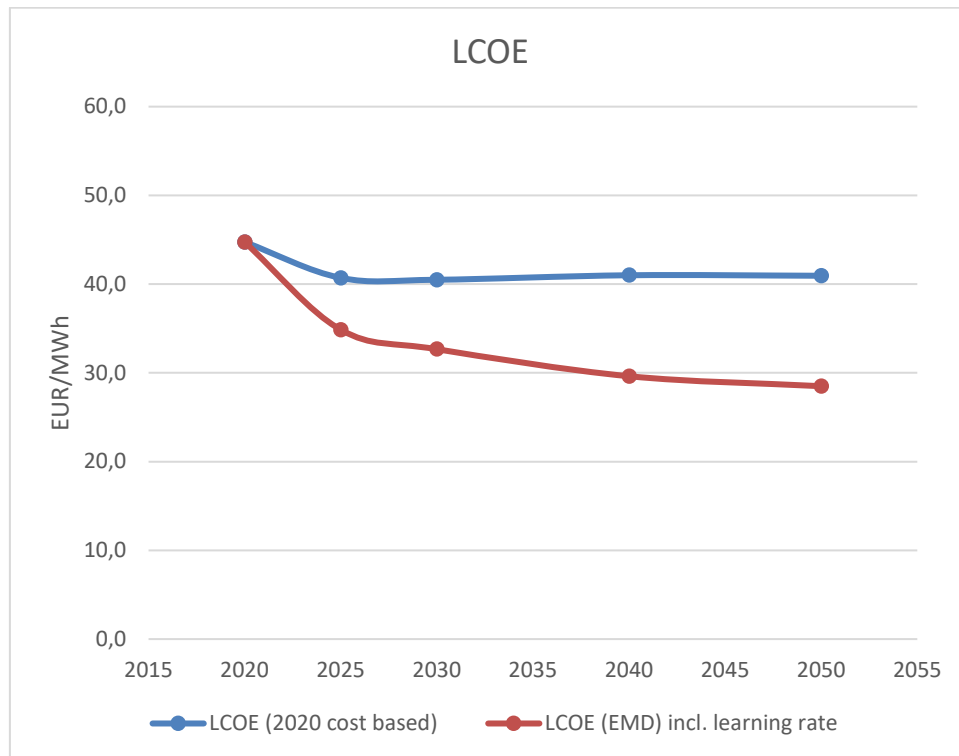

Figure 19 LCOE development for the assumed designs, without and with learning rate.

It is worth noticing that without the effects of the learning rate, the LCOE is expected to stabilize for the representative sites between 2030 to 2050. This effect is because the higher Capex due to deeper waters and larger distance to shore is compensated by the increased production due to higher wind speed in higher hub heights and fewer wake losses of the larger turbines.

### Uncertainty

There are several uncertainties, not just in cost and improvement of performance of the technology, but also on supply chain and service opportunities. The cost reductions related to supply chain and service are dependent on the international level of deployment of wind power as well as the national availability of services, which are dependent on the continuity and level of national deployment of offshore wind power. Another highly volatile uncertainty is the raw material cost development. In this context it is assumed that changes in raw material prices will balance off in the longer run, while possible short-term effects are neither predicted nor accounted for. Especially the availability of more rare or limited materials like copper or rare earth metals used for permanent magnets could potentially create larger fluctuations on raw material markets.

#### Future demands offshore

In the future, it could be expected that the offshore wind turbines will be met with

- More focus on wildlife issues due to larger and more numerous projects,

- More demands on participation in grid regulation and grid expansion in general,
- New solutions for storing the produced power, like Power-to-X solutions.
- Sustainability requirements will also play a large role going forward

### Floating offshore wind

Floating offshore wind is in rapid development. While the application of bottom-fixed offshore wind is currently limited to water depths of 60 m or less, floating technologies can in principle be applied at any water depth above 30-40 m. Practical applications are likely to be limited to water depths less than 1000-1500 m due to the cost of mooring systems, but even so IEA has estimated that the commercially viable floating offshore wind resource may exceed the world's total electricity consumption by up to a factor of 10 [24].

Three main concepts of floating substructures are available, differing in the way they obtain the floating stability that is required to keep the turbine upright under all wind and wave conditions. The spar buoy concept relies on ballast for stability, having the centre of gravity of the total assembly below the centre of buoyancy. The semisubmersible concept relies on buoyancy for stability. It has lateral columns that penetrate the waterplane and are submerged to a varying degree when the turbine heels over due to bending moments caused by wind and wave loads, and the differences in buoyancy as a function of the submersion of the columns creates the restoring moment. The tension leg or TLP concept relies on the mooring system for stability. It has vertical or near-vertical mooring lines that are kept taut by the buoyancy on the substructure, and bending moments caused by wind and wave loads are countered by a restoring moment arising out of differences in line tension.

Standard offshore wind turbines can be used for floating applications; the only two modifications required are tower reinforcement and motion control software. The tower reinforcement is needed to account for the additional loads caused by tower inclinations and wave-induced accelerations, and the motion control software ensures stability during operation above rated power where standard pitch regulation algorithms lead to low or even negative aerodynamic damping.

In floating wind, the wind turbines are typically installed on the floating substructures at the quayside using land-based cranes. Towing of the fully assembled structure and hook-up to the pre-laid mooring system at the installation site can be carried out with large tugs, anchor handlers or similar vessels of a few thousand tons displacement, thereby eliminating the need for large and expensive installation vessels. A wide range of mooring systems is available, most commonly three or more drag anchors are connected to the floating substructure with a combination of chains and wire ropes. So-called dynamic cables are used as array cables; they are ordinary subsea cables fitted with additional steel wire reinforcement ensuring that bending resulting from substructure movement is kept within a range that minimizes fatigue loading on the cable conductors.

During wind and wave conditions where crew transport is considered safe a floating substructure has no noticeable movements, and normal O&M can be carried out using the same vessels and methodologies as for bottom-fixed offshore turbines. Self-hoisting cranes and vessel-mounted cranes with motion control are being developed, but at the present time it is generally assumed that a floating wind turbine will require tow back to port in case of main component replacement.

At the present time only a limited number of floating substructures have been demonstrated. The first demonstrators were installed around 2010 by Equinor (a spar buoy concept) and Principle Power (a semisubmersible concept), and both of these parties have subsequently demonstrated their technologies in small wind farms. A barge-type variant of the semisubmersible concept was installed by the French company Ideol in 2017, and a spar buoy was installed by the Danish company Stiesdal Offshore Technologies in 2021.

At the present time two Danish companies are active in the development of floating offshore substructures, Stiesdal Offshore Technologies and Floating Power Plant.

Stiesdal has developed the Tetra technology, a fully industrialized manufacturing concept where all substructure components are factory-manufactured and subsequently assembled in the port of embarkation. The manufacturing concept can be applied to all three substructure concepts. In 2021, a first spar-configuration demonstrator fitted with a 3.6 MW 130 m turbine was installed at 200 m water depth at the METCentre test site off the coast of Norway.

Floating Power Plant has developed the FPP Platform, a substructure integrating wind and wave power. A first full-scale demonstration project may be installed at the PLOCAN test site of the Canary Islands as early as 2024.

The commercial potential for application of floating offshore wind in Denmark is unknown. For the foreseeable future the large areas of moderate water depth available in the Denmark's exclusive economic zone will be more than adequate for build-out using well-established bottom-fixed technologies. Some future applications in deeper-water parts of Kattegat and the Baltic may be envisaged.



Figure 20 The Stiesdal TetraSpar full-scale demonstration project | Photo credit: TetraSpar Demonstrator ApS.

### Data sheets

See separate Excel file for Data sheet, in which the prices are given in 2020-€.

## References

- [1] EMD International a/s, <http://www.windprospecting.com/>, 2015 and 2021
- [2] Enercon Product overview, 2012. [Online]. Available: [http://www.enercon.de/p/downloads/ENERCON\\_PU\\_en.pdf](http://www.enercon.de/p/downloads/ENERCON_PU_en.pdf).
- [3] Siemens Wind Power, 2014. [Online]. Available: <http://www.energy.siemens.com/br/pool/hq/power-generation/renewables/wind-power/Product-Sheet-HWRT.pdf>.
- [4] In-house estimation of hourly power output from an offshore wind farm in the North Sea.
- [5] Stiesdal, Offshore wind turbine size prediction tool.xlsx, with changes by Danish Energy Agency.
- [6] Master data register of wind turbines at end of September 2021, Danish Energy Agency.
- [7] The Danish offshore wind farm demonstration project: Horns Rev and Nysted offshore wind farms. Review report 2005, Ørsted and Vattenfall, 2006.
- [8] DTU International Energy Report – Wind Energy, DTU, 2014.
- [9] Energy Technology Perspectives 2008, IEA, 2008.
- [10] Wind Turbine Design Cost and Scaling Model L. Fingersh, M. Hand, and A. Laxson, Technical Report NREL/TP-500-40566 December 2006 <https://www.nrel.gov/docs/fy07osti/40566.pdf>
- [11] Wind PACT Turbine Design Scaling Studies: Technical Area 4— Balance-of-Station Cost 21 March 2000—15 March 2001, <https://www.nrel.gov/docs/fy01osti/29950.pdf>
- [12] Positioning of Danish offshore wind farms until 2030 - using Levelized Cost of Energy by Gyde Liane Ohlsen, Supervisors: Niels-Erik Clausen & Asger Bech Abrahamsen, Risø, 7th of February 2019  
[https://backend.orbit.dtu.dk/ws/portalfiles/portal/170361654/MScThesisDefense\\_GydeOhlsen\\_revised\\_03\\_2019.pdf](https://backend.orbit.dtu.dk/ws/portalfiles/portal/170361654/MScThesisDefense_GydeOhlsen_revised_03_2019.pdf)
- [13] Danish Energy Agency, Technology Catalogue 2019
- [14] IRENA Power Generation Cost 2020, <https://www.irena.org/publications/2021/Jun/Renewable-Power-Costs-in-2020>
- [15] Interview with Per Stenholt, Vattenfall, November 21
- [16] EA Energy Analyse/Cowi April 20 slide 25: [https://www.ea-energianalyse.dk/wp-content/uploads/2020/05/1949\\_Offshore-wind-and-infrastructure.pdf](https://www.ea-energianalyse.dk/wp-content/uploads/2020/05/1949_Offshore-wind-and-infrastructure.pdf)
- [17] From ENS 2021: FT - omkostninger Anholt, HR3, KF.xlsx
- [18] NREL Technology Baseline [Offshore Wind | Electricity | 2021 | ATB | NREL](#)
- [19] IEA World Energy Model [Techno-economic inputs – World Energy Model – Analysis - IEA](#)
- [20] WoodMackenzie, Europe levelised cost of electricity (LCOE) report, September 2021
- [21] EMD calibrated calculations of selected DK offshore wind farms, dec.21.
- [22] Energiwatch: Teknisk er Siemens Gamesa klar til 20 MW-møller og rotorere på 300-meter. 19<sup>th</sup> of May 2020. Retrieved 17<sup>th</sup> of February 2022: <https://energiwatch.dk/Energinyt/Renewables/article12148151.ece>
- [23] DTU Wind Energy: Pushing the physics of the large turbines of the future. 2021. Published in DTU International Energy Report 2021: Perspectives on Wind Energy. <https://doi.org/10.11581/DTU.00000208>
- [24] IEA, Offshore Wind Outlook 2019: <https://www.iea.org/reports/offshore-wind-outlook-2019>
- [25] EMD cost and AEP Excel calculation tool, March 2022



## 22 Photovoltaics

### Contact information:

Danish Energy Agency: Christoph Wolter, [chwo@ens.dk](mailto:chwo@ens.dk)

Author: Ea Energy Analyses and Jan Vedde, SiCon

### Publication date

March 2015

### Amendments after publication date

| Date               | Ref.                                  | Description  |
|--------------------|---------------------------------------|--|
| <b>February 22</b> | Qualitative description and datasheet | Technology description revised and updated<br>Updated data sheets for small (residential) and medium (commercial/industrial) rooftop PV, and large utility scale fixed and single axis tracking PV   |
| <b>November 19</b> | Qualitative description and datasheet | Technology description revised and updated,<br>Updated data sheet for large utility scale PV systems,<br>New data sheet for large utility scale PV systems with single axis tracker,<br>Updated description of losses of small and medium sized systems equivalent to data sheets of utility scale systems |
| <b>November 18</b> | Qualitative description               | Qualitative description for financial data added   |
| <b>July 18</b>     | Data sheet                            | Updated data sheets for small and medium sized systems   |
| <b>October 17</b>  | Data sheet                            | Updated data sheets for large utility scale PV systems   |

### Brief technology description

A solar cell is a semiconductor component that generates electricity when exposed to solar irradiation. For practical reasons several solar cells are typically interconnected and laminated to (or deposited on) a glass pane to obtain a mechanical ridged and weathering protected solar module. The photovoltaic (PV) modules are divided into two distinct classes by application where residential panels typically are 1.5 – 2.1 m<sup>2</sup> in size whereas the panels for utility scale projects are 2-3 m<sup>2</sup> in size. Module for both applications will have similar power density in the range 190-220 W<sub>p</sub> pr. m<sup>2</sup> and may be made from all the absorber materials mentioned below. They are sold with a product warranty of typically ten to twelve years, a power warranty of minimum 25 years and an expected lifetime of more than 30-35 years depending on the type of cells and encapsulation method.

PV modules are characterised according to the type of absorber material used:

- Crystalline silicon (c-Si), the most widely used substrate material is made from purified polysilicon feedstock and come in the form of mono- or multicrystalline silicon *wafers*. Monocrystalline solar cells are made from wafers sliced from a cylinder-shaped monocrystalline silicon ingot while multicrystalline solar cells are made of wafers sliced from square blocks of casted silicon where the monocrystalline grains are 5-50 mm in size.

Silicon based solar cell technology in its monocrystalline version is expected to dominate the world market for decades due to significant cost and performance advantages (Ref 1, 2, 3 & 5) . Currently, monocrystalline cells have higher efficiencies relative to its multicrystalline counterpart, but they also have a higher potential for efficiency increases, which makes it the preferred choice of many manufacturers.

- Thin film solar cells, where the semiconducting absorber layer made from materials like amorphous/microcrystalline silicon (a-Si/ $\mu$ c-Si), Cadmium telluride (CdTe) or Copper Indium Gallium (di)Selenide (CIGS) are deposited on the solar module glass-cover in a micrometre thin layer. Tandem junction and triple junction thin film modules are commercially available for niche application. In these cells several layers are deposited on top of each other in order to increase the light spectral responsivity specifically for each layer.
- Monolithic III-V solar cells, made from compounds of group III and group V elements (Ga, As, In and P), are often deposited on a Ge substrate. These materials can be used to manufacture highly efficient multi-junction solar cells that are mainly used for space applications or in Concentrated PhotoVoltaic (CPV) systems. CPV mainly utilises the direct beam component of the solar irradiation, which makes it ideal in climate types dominated by direct sunlight in contrast to Danish conditions where diffuse sunlight makes up half of the solar resource. Dye-Sensitized solar Cells (DSC) and Polymer/Organic Solar Cells are emerging technologies where significant research activities are among others currently addressing efficiency and lifetime issues. These cells are currently not considered candidates for grid-connected systems.
- Perovskite PV cells, are made from a hybrid of organic-inorganic lead or tin halide-based materials (salts) which are organised in a Perovskite structure. Perovskite solar cells have, under lab conditions, shown a remarkable progress over the years with respect to efficiency. The potential of perovskites is, however, paired with serious concerns related to their toxicity and performance stability. The best perovskite absorbers contain soluble organic lead compounds that are toxic and environmentally hazardous at a level that calls for extraordinary precautions. Therefore, the perovskite's health and environmental impact shall be analysed before they eventually are considered as a viable absorber material in solar cells. Furthermore, challenges in industrial scale manufacturing and long-time stability with acceptable degradation are presently not solved. It is currently uncertain when this type of PV cells will become commercially available. The largest potential to apply perovskite solar cells are seen as a top-layer cell in a multi-stacked tandem cell where a traditional c-Si device is used as substrate and absorber for the longer wavelength photons. Other materials like copper zinc tin sulfide (CZTS) with proven stability but currently lower conversion efficiencies candidate to become the preferred top-layer in a next generation tandem cells.

In addition to PV modules, a grid connected PV system also includes Balance of System (BOS) consisting of a mounting system (rails/coverings for roof mounting and fixed tilt tables or tracking systems for ground mounted PV), a dc-to-ac current inverter (central, string and/or optionally module level power electronics, optimizers or microinverters (relevant for BIPV)), dc- and ac-cables and finally monitoring equipment, transformers and power plant controller (for utility scale PV power plants only).

#### Crystal growth method

The multicrystalline casting method has been the dominating crystallisation technology since the early 2000's due to the flexibility in utilisation of any kind of purified silicon no matter form (broken wafers, tops and tails from monocrystalline growth) and residual contamination. Over the last few years this method is being phased out as seen in Figure 1 that presents the relative global marketshares for the various cell categories.



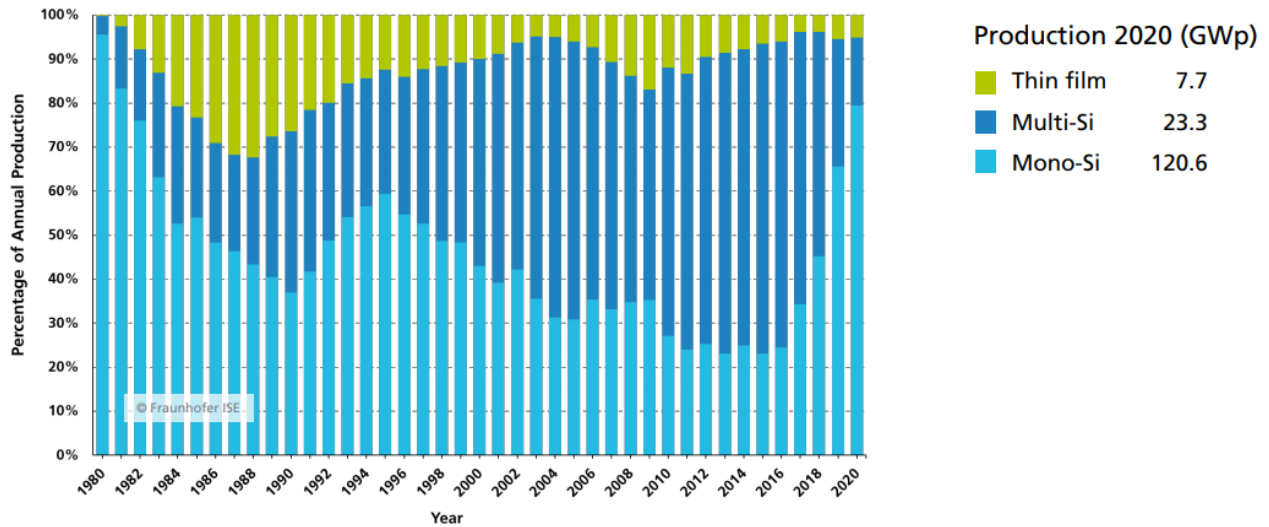

Figure 1 Historical market shares of different cell technologies (Ref. 9).

All major PV companies (except for First Solar) are now in the process of converting to a full monocrystalline focus by adding only new manufacturing capacity based on Mono-solutions due to their slightly higher efficiency 21-22% as compared to 17-18%. In 2020, 80% of the global solar market was based on monocrystalline products (Ref. 9). The market share is expected to increase further in 2021.

In addition, other macro-trends are foreseeable to change the landscape of silicon products over the next few years, as both a trend towards larger wafer sizes (166 x 166 mm, 182 x 182 mm, and 210 x 210 mm) and n-type products are expected to become mainstream. These developments however are happening so fast, that current market reports and statistics have not yet captured this development. The increase in wafer size relate to an optimisation related to wafer-to-cell-to-module processing costs, where some subprocesses bear costs that scale with area (i.e. will not benefit from an increase in unit area per wafer), while the costs of other processes (batch) scale with units and therefore will decrease when the area of a wafer increases. The shift from p-type to n-type represents a change of main doping (from Boron or Gallium to Phosphorous) and thereby a change of the electrical charge of the majority electricity carrier in the wafer from positive (holes) to negative (electrons) which results in a longer minority carrier lifetime – which is a key cell design optimisation parameter as understood in terms of semiconductor physics.

### Wafer slicing method

The active silicon substrate that constitutes the solar cell is sliced from the ingot or block with a wire-saw. Since the technology was invented in the 1990'es, hard silicon carbide particles in a slurry of glycol have been the preferred abrasion material. However, during the last few years, this solution has almost entirely been replaced by diamond coated wires and regular cooling water. This method has demonstrated to be cheaper in operation, as it eliminates the slurry recycling operation, provides a potential to cut thinner wafers and provides a wafer surface better suited for post-cleaning structuring into micro-pyramids or other anti-reflecting surface treatments by etching.

### Solar cell architecture

Whereas the main cell technologies until a few years ago were based on the screen-printed Al-BSF (sintered aluminum paste based back surface field) solar cells, which represent a very old, reliable and versatile solar cell architecture adaptable for both mono- and multicrystalline wafers, other concepts, which already were developed in the 1980's, have recently been introduced into large scale manufacturing. Most dominating is the PERC (Passivated Emitter and

Rear Cell) architecture, where an extra processing step has been added to reduce carrier recombination at the surface by “passivating” these surfaces (typically by a nanometer thin layer of silicon dioxide, aluminium-oxide or (oxy-)nitrides). Also, alternative architectures like PERT (passivated emitter rear totally diffused), HJT (Heterojunction Technology) or TopCON (Tunnel Oxide Passivated Contact) are also now being introduced in GW-sized manufacturing facilities all due to the higher efficiency potential that can be obtained (up to 24-25% as compared to the Al-BSF maximum around 20-21%).

### Solar module

The encapsulation of cells into a PV module has undergone several changes over the last few years. Whereas the front protection is still made by a 2.2 – 3.2 mm thick antireflective coated semi-toughened microstructured glass, more and more modules have the backsheets polymer foil replaced by another glass pane, whereby a more mechanically rigid and better-protected structure is obtained. This also opens for an optional elimination of the aluminium frame. Additionally, more transparent encapsulation materials known as polyolefins are now in use and anti-soiling surface coatings have been introduced (Ref. 42).

### **Bifacial PV-panels and half-cut cells**

On top of the above listed upgrades and improvements in various manufacturing steps, yet another technology change has been introduced and found fast acceptance in the market, namely the opportunity to utilize solar energy that reaches the cell from both the front and backside of the PV module through the usage of bifacial cells. This is yet a further advantage of the PERC solar cell, as the backside does not block the light from entering the silicon bulk absorber (in contrast to the Al-BSF cell, where opaque aluminum covers the whole cell backside). Bifacial panels are today mainly used for utility scale ground-mounted systems, where light that reaches the ground between the rows may be reflected by grass or other reflecting material on the ground (snow, stone etc.). Also, commercial roof top systems where the modules are installed with a tilted mounting substructure on a flat roof may take advantage, as white painted roofs may have a very high albedo and thereby reflection of light to the back of the module.

In addition to bifacial modules, also half-cut cell technology has gained market attraction and demonstrated a large potential over a very short time. Whereas all ingot, wafer and cell manufacturing processes remain unchanged, the square cells are simply cut into two equally sized half cells and then placed next to each other in the PV panel that now contains 144 half-cut cells in contrast to the previous 72 cell module type for utility scale systems. Roof top systems usually apply smaller panels containing 60 cell modules, which then makes 120 half-cut cells. Although the overall area of the module hereby increases a little due to the additional amount of cell-to-cell spacing, the overall module power uplift of approximately 5  $W_p$  most often outweighs this disadvantage related to a decrease in the module area-efficiency.

The new large power (600 W<sub>p</sub>) format (2.8 m<sup>2</sup>) bifacial PV panels with half-cut cell technology modules are already now being installed in Denmark and are expected to soon become the new standard for utility-scale installations (together with even larger modules that soon are expected to be commercialized). Silicon-based bifacial modules' global market shares are expected to reach an 80% market share in 2031 globally, shown in Figure 2, due to generation gains at a low additional cost (Ref. 14, 19). For utility scale systems, it is reasonable to believe that bifacial modules become the preferred technology after 2021.

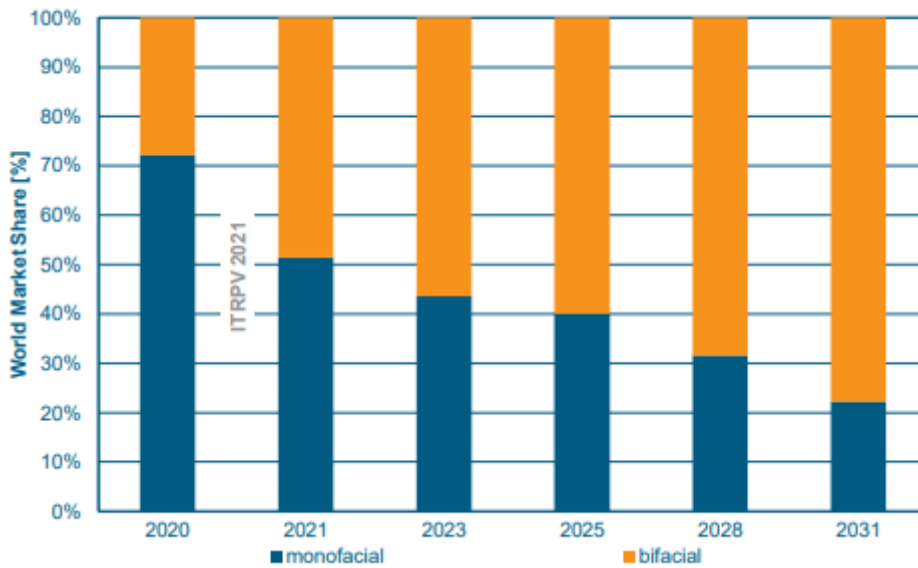

Figure 2 Silicon-based mono- and bifacial module global market shares (Ref. 19).

Figure 3 shows the functional principle of a bifacial solar panel against a monofacial module.

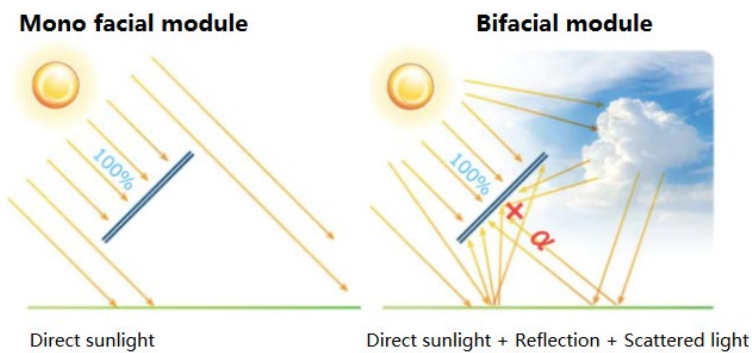

Figure 3 Bifacial module structure (Ref. 12).

Whereas most commercial power prediction software only assumes a small uplift of 4% in energy production due to bifaciality on fixed tilt substructures, other studies indicate that this uplift may be in the range of 6% to 8% when compared to monofacial-panel PV panels with the same cell type installed at the same location in Denmark (Ref. 7, 21). The specific gain is dependent on a wide range of factors such as height of panel installation, fixed tilt or trackers, ground albedo, avoidance of backside shadowing by the sub-structure, inclination, geographical location, weather conditions etc. Note that the relative contribution of the bifacial cells is higher in cloudy weather due to a higher share of diffuse sky radiation.

### Utility scale PV with tracking system

In Southern Europe single axis tracker systems have become the new standard (Ref. 14), however as of November 2021, there are only three utility scale PV plants with trackers in Denmark. This may change in the coming years as cost reductions on trackers, capacity payments for grid-connection and use of trackers in Agro-PV installation does favor tracker solutions. A reverse trend may on the other hand also be seen due to the very high landlease costs compared to a limited performance uplift of trackers in Denmark. Dansk Solkraft has published an outlook for PV in Denmark by 2030, where a trackerfraction in Danish projects of 25% has been assumed.

### Single axis tracking

Single axis tracking systems allow rotation of the PV-panels around a single axis. This can either be around a horizontal or tilted axis. This is realized by connecting an electric motor to a steel-beam (torque tube), which carries transverse steel beams that are used to mount the panels on the beam. In countries located on the northern hemisphere, such as Denmark, it is most customary to install long vertical single axis systems that allow rotation from facing east to west during the day, shown in Figure 4.

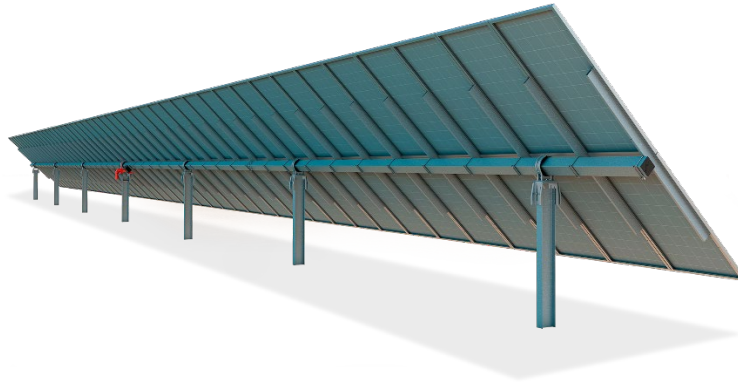

Figure 4 Single axis tracking system on the vertical axis (Ref. 15).

### Dual axis tracking

Dual axis tracking systems allow rotation of the PV-panels both horizontally and vertically. It has two respective motors for rotation on each axis. This allows for the minimization of the incidence angle between the sun and the solar panel, which in turn maximizes the generation. However, the mounting structure can only support fewer modules (usually limited to 10 kW<sub>p</sub> per tracker structure) and two motors are required, causing the investment costs to be significantly higher than for single-axis tracker solutions. For that reason, it is uncommon to apply dual-axis tracker technology for utility scale PV plants, unless a version of CPV that can only utilize the direct (beam) component in the sunlight is installed. An illustration of a dual axis tracker is shown in Figure 5.

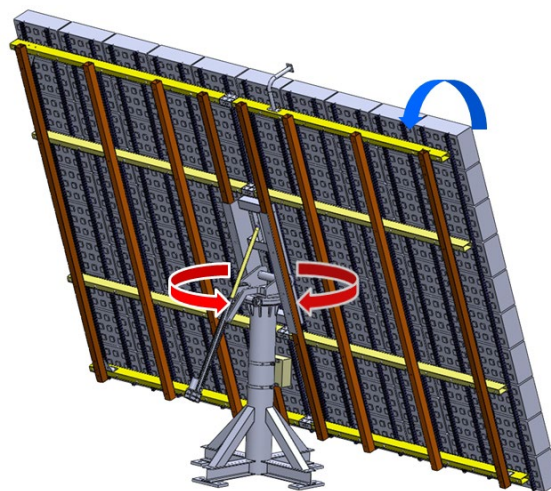

Figure 5 A generic dual axis PV system (Ref. 11)

### 1.5 axis tracking

A 1.5 axis tracking system is a fusion of the single and dual axis system because the system can partly operate on both axes. The 1.5 axis system only has one motor for rotation on both axes and requires a panel structure, which does not allow an inclination angle below 30 degrees. This results in a similar generation with respect to the dual axis system in

seasons with a high solar elevation angle as well as a low seasonal angle difference. However, the generation is reduced with respect to the dual axis system if the sun's elevation angle is below 30 degrees, which is the case for most of Europe in winter. Because the tracking system only needs one motor, the investment costs are lower relative to the dual axis tracking system. Still like the dual axis tracking system, the mounting structure can only support a few modules, making the technology less relevant for large utility scale PV plants. An example of a PV 1.5 axis tracking system is shown in Figure 6.



Figure 6 A Helioslite 1.5 tracking system (Ref. 13).

### Performance of tracking systems

PV panels with any kind of tracking system will have an increased power generation with respect to fixed mount systems. This additional performance ability for tracking systems depends on geographical location, type of PV-module, type of control system, time horizon for measurements and inclination angle applied.

It is estimated that single-axis tracking systems can increase generation by approximately 15% with respect to fixed mount systems in Denmark. The production pattern of single axis trackers is slightly different to fixed systems as they have an increased generation in the early and late daylight hours while having a decreased peak in the middle of the day. In general, the generation pattern is more beneficial for the power system as the output is usually less fluctuating throughout the day.

In Denmark, the generation from dual tracking systems can be increased by up to 25-27% with respect to fixed mount systems, however, due to the drawbacks mentioned above neither 1.5 nor 2-axis tracking systems are currently considered relevant for large-scale application in Denmark.

### PV module power (capacity)

The energy generation capacity (power) of a solar module depends on the intensity of the irradiation the module receives, incidence angle, spectral distribution of the solar radiation as well as module temperature. For practical reasons the module power is therefore referenced to a set of laboratory Standard Test Conditions (STC) which corresponds to an irradiation of  $1000 \text{ W/m}^2$  with an AM1.5<sup>13</sup> spectral distribution perpendicular to the module surface and a cell temperature of  $25 \text{ }^\circ\text{C}$ . This STC capacity is referred to as the peak capacity  $P_p$  [ $\text{kW}_p$ ].

<sup>13</sup> The air mass coefficient defines the optical path length of solar irradiation when travelling through the Earth's atmosphere, relative to a vertical path.

### Losses and corrections

As the actual operating conditions will always be different from Standard Test Conditions, the average capacity of the module over the year will therefore differ from the peak capacity. The capacity of the solar module is reduced compared to the  $P_p$  value when the actual cell temperature is higher than 25 °C, when the irradiation received is collected at an angle different from normal direct irradiation and when the irradiation is lower than 1000 W/m<sup>2</sup>. Besides, some of the electricity generated from the solar modules is lost in the rest of the system, e.g. in the DC-to-AC inverter(s), cables, combiner boxes and for larger PV power plants also in the transformer. The power generation from a PV installation with a peak capacity  $P_p$  can be calculated as:

$$\text{Energy} = P_p * \text{Global Horizontal Insolation} * \text{Transposition Factor} * \text{Performance Ratio}$$

For practical reasons, the various losses are often compiled into a single factor, called the performance ratio, which describes the energy yield of the actual system relative to a reference system operating under ideal Standard Test Conditions. This factor describes all energy losses components in the real system, which include optical losses related (light reflections from the glass surface), electrical losses (electrical string mismatch loss, dc- and ac-resistive losses), performance losses as compared to datasheet STC-values (while operating at temperatures different from 25 °C, light intensities different from 1000 W/m<sup>2</sup> and spectral conditions different from AM1.5 etc.) as well as inverter- and transformer losses, snow- and soiling loss etc. The uplift from bifaciality, albeit not part of the STC  $P_p$  measurement, is typically included in the performance ratio or presented separately.

### Inverter capacity and sizing factor

The capacity of the inverter, also known as the rated power, defines the upper limit for power that can be delivered from the plant. The plant capacity  $P$  [W<sub>ac</sub>] is defined as the minimum capacity between this inverter capacity and the grid capacity as agreed with the utility, i.e. the minimum capacity the plant is able to feed into the grid. The relationship ( $P_p/P$ ) between the peak capacity  $P_p$  [W<sub>dc</sub>] and the plant capacity  $P$  is called the sizing factor. A high sizing factor leads to energy “clipping” during peak hours, but at the same time reduces cost for inverters and grid connection. The sizing factor is optimised differently whether the limiting factor of the installation is availability of area, availability of grid capacity, subsidy scheme, imposed constraints on the allowed nominal power, daily self-consumption profile, fixed physical orientation or tilt angle of the modules etc. The range for the sizing factor is generally within 1.0 to 1.35 globally.

Historically, the sizing factor for utility scale PV facilities in Denmark used to be quite high, for some plants up to 1.5, between 2012 and 2019 when subsidy schemes were applicable for plant sizes limited by an ac-capacity of either 400- or 499-kW<sub>ac</sub>.

The typical sizing factor later was reduced to around 1.25 to reflect the relative low cost of the dc- to ac-inverter and low value of energy lost by inverter clipping, and also due to the fact that the current grid tariff schemes in Denmark do not include a capacity-based payment, for which reason it is attractive to match and unify inverter and grid capacity.

Sizing factor design criteria changed again in 2021, when the implication of the national implementation of the EC regulation 2016/631 related to Network Code on Requirements for Generators was realized by the Danish developers. Due to requirements for the larger category C and D projects to establish large reserves of reactive power capacity to be available for system stability under extreme operating conditions, it has been necessary to reduce the sizing factor to a level below 1.1.

In the coming years, the sizing factor might change again among others as a possible reaction to the planned introduction of connection fees that solar PV developers can face, and the induced possible relocation of some projects



and consequential changes on a project level in terms of the limiting factors mentioned above. The rationale for the introduction of these fees is to incentivize a solar PV development with the lowest total grid connection cost.

In summary, both the extent to which tracker systems may become commercially attractive in Denmark and the framework conditions (capacity payments and network code requirements) under which utility scale projects may be connected to the grid (DSO and TSO), will influence the sizing factor. How the utility scale PV sizing factor will develop in the coming years is therefore associated with uncertainty.

**Wear and degradation**

In general, a PV installation is very robust and only requires a minimum of component replacement over the course of its lifetime. The inverter typically needs to be replaced every 10-15 years. For the PV module only limited physical degradation will occur. It is common to assign a constant yearly degradation rate of 0.3 – 0.5 % to the overall production output of the installation. This degradation rate does not represent an actual physical degradation mechanism, but rather reflects general failure rates following ordinary reliability theory with an initial high (compared to later) but rapidly decreasing “infant mortality” followed by a low rate of constant failures and with an increasing failure rate towards the end-of-life of the various products (Ref. 13). Failures in the PV system are typically related to soldering, cell crack, hot spots, yellowing or delamination of the encapsulant foil, junction box failures, loose cables, hailstorm and lightning (Ref. 14). Degradation is difficult to assess on a project level, as the magnitude of degradation easily can be offset or overwhelmed by other factors influencing the individual system’s efficiency (Ref. 2).

**Input**

Solar radiation is the input of a PV panel. The irradiation, which the module receives, depends on the solar energy resource potential at the location, including shading conditions and the orientation of the module.

The average annual solar irradiance received on a horizontal surface in Denmark is  $1068 \pm 33$  kWh/m<sup>2</sup>/year (Ref. 4).

The distribution of this solar energy over the year is illustrated in Figure 7.

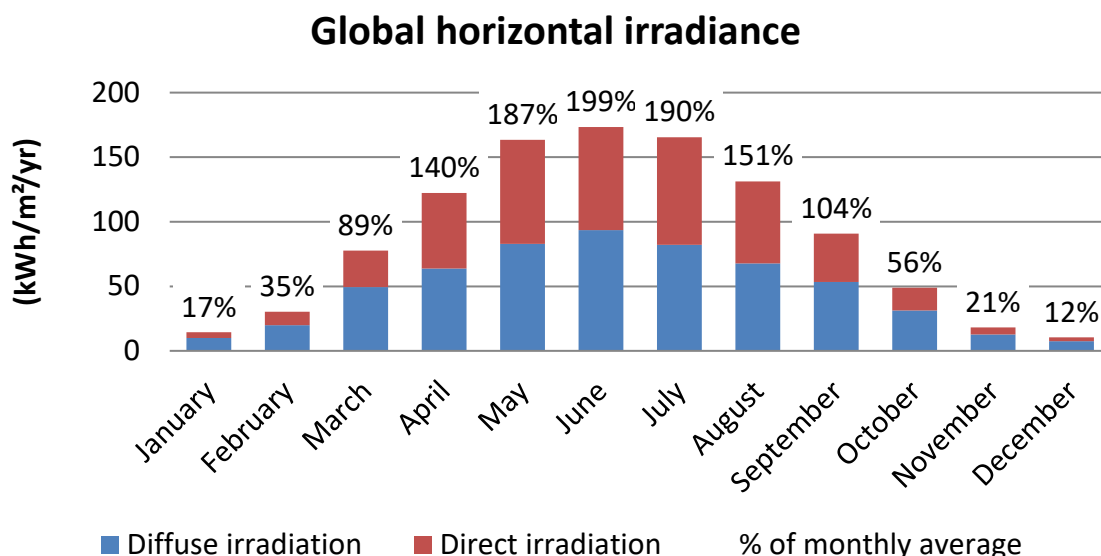

Figure 7 Monthly sum of global irradiance on a horizontal surface averaged over 25 Danish measurement stations over a period of 10 years (2001-2010) (Ref 4). The split between direct and diffuse components of the insolation is based on the Meteonorm '97 dataset

Both direct light (beam) and diffuse components of the light, which in Denmark typically comprise approximately 50 % of the energy each, can be utilised. This implies a fairly high degree of freedom in orienting the PV modules, both with respect to inclination and orientation East-West.

For a fixed tilt system, where modules are installed in a 15-45 degrees inclination angle, the available energy received in the plane of the PV module (glass surface) is increased compared to horizontal by a so-called transposition factor of 1.10 - 1.19. In Denmark, the inclination angle that yields the highest generation is approximately 39 degrees, but in practice, utility scale PV plants are typically installed with a 25 degrees tilt angle (1.17 transposition factor) to reduce shadow effects between rows, thereby decreasing the spatial footprint per installed capacity, and to reduce the wind load on the panels.

Panels facing other directions than south receive less energy than panels facing directly towards south. Table 1 shows the transposition factor for different orientations of a fixed tilt panel.

**Table 1 Transposition factor for solar modules as function of orientation calculated for Risø near Roskilde in Denmark by the program PVsyst based on the Meteonorm (1991-2000) dataset.**

**Transposition Factors for Risø (Denmark)**  
**Period : Whole year --- Horizontal Global Irrad. = 998 kWh/m2**

| Azimuth | -90° | -75° | -60° | -45° | -30° | -15° | 0°   | 15°  | 30°  | 45°  | 60°  | 75°  | 90°  |
|---------|------|------|------|------|------|------|------|------|------|------|------|------|------|
| Tilt    |      |      |      |      |      |      |      |      |      |      |      |      |      |
| 90°     | 0.63 | 0.70 | 0.75 | 0.80 | 0.83 | 0.86 | 0.87 | 0.87 | 0.86 | 0.83 | 0.79 | 0.73 | 0.66 |
| 80°     | 0.71 | 0.78 | 0.84 | 0.90 | 0.94 | 0.96 | 0.97 | 0.97 | 0.96 | 0.93 | 0.88 | 0.81 | 0.73 |
| 70°     | 0.78 | 0.85 | 0.92 | 0.98 | 1.02 | 1.05 | 1.06 | 1.06 | 1.04 | 1.01 | 0.95 | 0.88 | 0.80 |
| 60°     | 0.83 | 0.91 | 0.98 | 1.04 | 1.09 | 1.12 | 1.13 | 1.13 | 1.11 | 1.07 | 1.01 | 0.94 | 0.86 |
| 50°     | 0.88 | 0.96 | 1.03 | 1.09 | 1.13 | 1.16 | 1.17 | 1.17 | 1.15 | 1.11 | 1.05 | 0.99 | 0.91 |
| 40°     | 0.92 | 0.99 | 1.05 | 1.11 | 1.15 | 1.18 | 1.19 | 1.18 | 1.16 | 1.13 | 1.08 | 1.01 | 0.94 |
| 30°     | 0.95 | 1.01 | 1.06 | 1.11 | 1.14 | 1.17 | 1.18 | 1.17 | 1.16 | 1.13 | 1.08 | 1.03 | 0.97 |
| 20°     | 0.97 | 1.01 | 1.05 | 1.09 | 1.12 | 1.13 | 1.14 | 1.14 | 1.12 | 1.10 | 1.07 | 1.03 | 0.98 |
| 10°     | 0.99 | 1.01 | 1.03 | 1.05 | 1.07 | 1.08 | 1.08 | 1.08 | 1.07 | 1.06 | 1.04 | 1.02 | 1.00 |
| 0°      | 1.00 | 1.00 | 1.00 | 1.00 | 1.00 | 1.00 | 1.00 | 1.00 | 1.00 | 1.00 | 1.00 | 1.00 | 1.00 |

Note that the typical tilt angle of 25 degrees directly south-facing panel will receive a transposition factor of 1.17, which is 0.02 lower than the maximum value at a 39-degree angle.

**Output**

All PV modules generate direct current (DC) electricity as an output, which then needs to be converted to alternating current (AC) by use of an inverter. Some modules (AC modules) come with an integrated inverter, which exhibits certain technical advantages, such as better modularity in installation, more flexibility in installation orientation of individual modules (standard string inverters require all modules in an electrical string to be installed in the same orientation), more shade resistance, easy shutdown in case of fire thus being safer, and simple AC-electrical work to be performed directly at the panel on the roof. However, these integrated inverters are more costly and therefore they are typically only applied in residential PV modules. As an alternative to AC modules, poweroptimizers exist, which are module connected DC/DC converters that allow modules subjected to different shadings to be connected to the same inverter, via the optimizer. These systems exist both where all modules need a poweroptimizer (Solaredge) and systems where only selected modules are equipped with a poweroptimizer (Tigo, Huawei). The power optimizer solution is cheaper compared to the microinverter solution, and offers the same safety and operational benefits.

The power generation depends on:

- The amount of solar irradiation received in the plane of the module (see above).



- Installed module generation capacity.
- Losses related to the installation site (soiling and shade).
- Losses related to the conversion from sunlight to electricity.
- Losses related to conversion from DC to AC electricity in the inverter.
- Grid connection and transformer losses.
- Cable length and cross section, and overall quality of components.

### Typical capacities

PV systems are available from a few Watts to Gigawatt sizes but in this context, only PV systems from a few hundred Watt to a few hundred MW are relevant.

PV systems are inherently modular with different typical module sizes for respective residential, commercial and utility scale applications. A typical module unit size is between 250 and 300 W<sub>p</sub> for residential purposes whereas utility scale size is currently between 450 W<sub>p</sub> and 600 W<sub>p</sub> (with new products/R&D products up to 670 W<sub>p</sub>)

The size of a typical *residential* installation in Denmark is normally between 4 and 6 kW<sub>p</sub> corresponding to an area of 25-40 m<sup>2</sup> for c-Si modules. Residential PV installations are often optimised for a high degree of self-consumption, with an inverter sizing factor around 1 to 1.1 but may also deliver surplus power to the outer radials of the distribution grid. To increase self-consumption, residential PV's can be combined with a small sized battery to absorb peak generation. Additional cost of a battery varies by size, but for a 6.7 kW<sub>p</sub> PV system, a 5 kWh lithium-ion battery will typically cost about 5,000-6,000 € excl. VAT including installation. The cost of the batteries may be covered by the savings obtained through increased self-consumption, including lower energy tax payments.

*Commercial* and *Industrial* PV systems are typically installed on residential, office or public buildings, and typically range from 50 to 500 kW<sub>p</sub> in size. Such systems are often designed to fill the available roof area but also for a high degree of self-consumption. They will typically have a sizing factor around 1 to 1.2 and may deliver non-self-consumed power to a transformer in the low voltage distribution grid.

*Utility scale* systems or PV power plants will normally be ground mounted and typically range in size from 0.5 MW and beyond. New utility scale plants in Denmark are typically between 20 and 60 MW<sub>p</sub> (as of 2021) but larger plants up to 300 MW<sub>p</sub> are also now under construction. They are typically operated by independent power producers that by use of transformers deliver power to either the medium voltage distribution grid or directly to the high voltage transmission grid. As previously described, the sizing factor may vary from 1.05 (due to RFG requirements) to 1.5.

### Space requirement

The module area needed to deliver 1 kW<sub>p</sub> of peak generation capacity can be calculated as  $1/\eta_{\text{mod}}$ , and equals 4.9 m<sup>2</sup> by today's standard PV modules. For modules on tilted roofs, 1 m<sup>2</sup> of roof area is needed per m<sup>2</sup> of module area. Modules on flat roofs and modules on ground will typically need more roof and land area than the area of the modules itself, in order to avoid too much shadowing from the other modules. Table 2 shows typical ratios of the area of the module to the ground surface required for the installation, so-called ground coverage ratios. For residential installations, the table shows the ratio between module area and roof area (assuming tilted roof installation).

Table 2 Ground coverage ratio and installed power density for different PV segments.

|                                    | Residential (rooftop) | Commercial (flat rooftop) | Utility (fixed tilt) | Utility (tracker) |
|------------------------------------|-----------------------|---------------------------|----------------------|-------------------|
| Ground coverage ratio (Ref. 6, 21) | 1.0                   | 0.8                       |                      |                   |
| Area requirement [ha/MWp]          |                       |                           | 1 -1.2               | 1.35-1.5          |

### Regulation ability

The generation from a PV system reflects the yearly and daily variation in solar irradiation. When connecting PV systems to the grid, a set of grid codes describing required functionality and communication protocol as set by the TSO and DSO must be respected. The detailed technical requirements depend on the system size and do not impose any specific technical demand that cannot be fulfilled by any modern PV inverter. However, for systems above 125 kW, a park controller which interfaces the grid operator is required to ensure system level remote control of all individual inverters, which then enables the system to deliver ancillary grid services like frequency response, reactive power, variable voltage output, or power fault ride-through functionality to the grid. Besides the park controller, a simulation model must be delivered to the utility for verification of the technical capability, and the development and delivery of this model can be quite complicated and troublesome for smaller installers. Utility scale PV plants may provide downregulation if generating or upregulation if not generating at maximum capacity, but today most PV systems supply the full amount of available energy to the consumer/grid.

The inverters of residential and commercial/industrial roof systems will follow the local grid characteristics and deliver their output according to the defined network codes. This also implies that the inverter must reduce its output in case the observed frequency or voltage conditions get outside predefined limits.

### Advantages/disadvantages

Advantages:

- PV does not use any fuel or other consumable.
- PV is noiseless (except for fan-noise from inverters and transformers).
- Power is produced in the daytime when demand is high.
- PV complements wind power as the generic seasonal/daily generation profile is different.
- PV offers grid-stabilisation features.
- PV modules have a long lifetime of more than 30 years and PV modules can be recycled to a high degree (Ref. 47).
- PV systems are modular and easy to install.
- Operation & Maintenance (O&M) of PV plants is simple and limited as there are no moving parts, with the exception of tracker systems, and no wear and tear. Inverters need only be replaced once or twice during the operational life of the installation.

- Large PV power plants can be installed on land that otherwise are of no or limited commercial use (watercollection/pesticide-free areas, landfills, low-lands, areas of restricted access or chemically polluted areas).
- PV systems integrated into buildings require no incremental ground space, and the electrical inter-connection and export capacity is readily available at no or small additional cost.
- Affordable aesthetic panels are expected to become available for building integration in the coming years.

### Disadvantages:

- PV systems have high upfront costs and a low capacity factor.
- Aesthetic concerns may limit the use of PV in certain urban environments and in the open space when the visual impact is unacceptable.
- PV installations can only provide ancillary services in specific situations as generation usually follows the daily and yearly variations in solar irradiation.
- Materials abundance (In, Ga, Te) is of concern for large-scale deployment of some thin-film technologies (CIGS, CdTe).
- Some thin-film technologies do contain small amounts of toxic cadmium and arsenic.
- The best perovskite absorbers contain soluble organic lead compounds, which are toxic and environmentally hazardous at a level that calls for extraordinary precautions.
- PV systems are quite area intensive as the  $MW_p/ha$  factor is typically around 0.8 – 0.9  $MW_p/ha$  for Fixed Tilt installations and down to 0.6 – 0.7 for Horizontal Single Axis Trackers, including additional areas ( $25 \pm 10\%$ ) required for internal roads, compounds and transformer stations.

### Environment

The environmental impacts from manufacturing, installation and operation of PV systems are limited.

Thin film modules may contain small amounts of cadmium and arsenic, but all PV modules as well as inverters are covered by the European Union "Waste from Electrical and Electronic Equipment" (WEEE) directive, whereby appropriate treatment of the products by end-of-life is organised. The exact methodology to be used when larger amounts of PV panels shall be decommissioned and recycled in 15-20 years from now may not be identified, but several projects are working on optimising solutions and preparing large scale facilities for this purpose, in a recent study 15 companies have been identified to be currently active in the PV reuse sector in Europe (44). One particular problem may arise from PV panels containing flour-based backsheets (PVF or PVDF), as these backsheets are difficult to melt into new materials due to the high melting temperature and risk of breakdown. Unless these materials are phased out from PV modules manufacturing (like when using double-glass bifacial modules) there is a potential risk that these slowly degradable materials may end up contaminating the environment and end-up in a human or animal foodchain.

All frontglass are coated with a 100 nm thick silicabased layer which have been sintered into the surface during tempering of the glass. This coating may be referred to as nano – due to the thickness – but does not contain any nanosized particles that may be washed off and thereby released to the environment. Therefore no risks have been identified in relation to installation of PV panels even above groundwater protection areas.

The energy payback time (EPBT) is dependent on multiple factors such as PV technology type, type of manufacturer and geographical location. The current average EPBT of a typical crystalline silicon PV system in Europe is 1 year, shown in Figure 8, which roughly corresponds to between 1 and 2 years for Denmark, due to a lower number of full load hours with respect to Southern Europe.

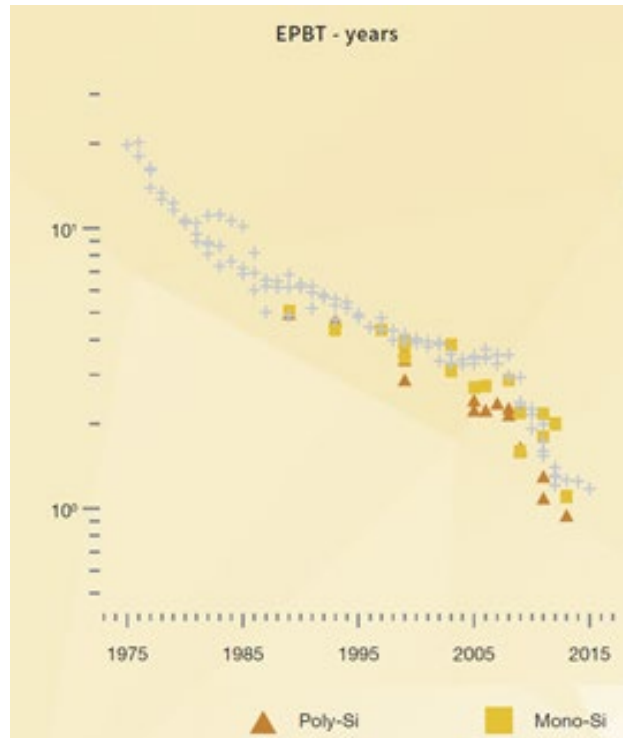

Figure 8 Historic energy payback time of PV modules (Ref. 14).

Generally, the multicrystalline cells have a slightly lower EPBT relative to monocrystalline since the process of making multicrystalline cells is less energy-intensive as crystal purity is prioritized for monocrystalline cells.

### Research and development perspectives

A trend in research and development (R&D) activities reflects a change of focus from manufacturing and scale-up issues (2005-2010) and cost reduction topics (2010-2013) to implementation of high efficiency solutions and documentation of lifetime/durability issues (since 2013). In the coming years, as PV plants are expected to play a key role in power generation, a higher focus on increasing the system value of PV generation is expected. R&D is primarily conducted in countries where manufacturing takes place, such as Germany, China, USA, Taiwan and Japan. Nevertheless, some R&D is also taking place in Denmark; the priorities in Denmark are (Ref. 8):

- Silicon feedstock for high-efficiency cells.
- New PV cells e.g. photo-electro-chemical, polymer cells, nanostructured and tandem cells.
- Advanced power electronics for intelligent operation of PV systems.
- Both building integration and building application of PV modules (BIPV<sup>14</sup> and BAPV<sup>15</sup>), design and aesthetics.
- System technology; realisation and modelling of the bifacial gains incl. integration in the electricity grid and digitalisation of O&M.
- Reinforced international cooperation with IEA, IRENA, the EU and the Nordic countries concerning PV and “Smart Grid” development.

<sup>14</sup> Building integrated photovoltaics.

<sup>15</sup> Building applied photovoltaics.

Examples of standard market technology

Efficiency

High efficiency solar cells and modules have been available for a decade based on interdigitated back contact or hetero-junction cell technologies. The efficiency of such monocrystalline solar cells is above 24%. PV modules with an efficiency of more than 22% are already commercially available. However, a typical *global* average value for commercially available PV modules today is 19-21%. Figure 9 shows that the average efficiency of commercially available monocrystalline panels has been improved steadily since 2006, reaching 18% efficiency in 2018. The average panel efficiency of most module manufactures in late 2019 was around 20%, as shown below.

Module efficiency trend for modules in mass production with different c-Si based cell technologies

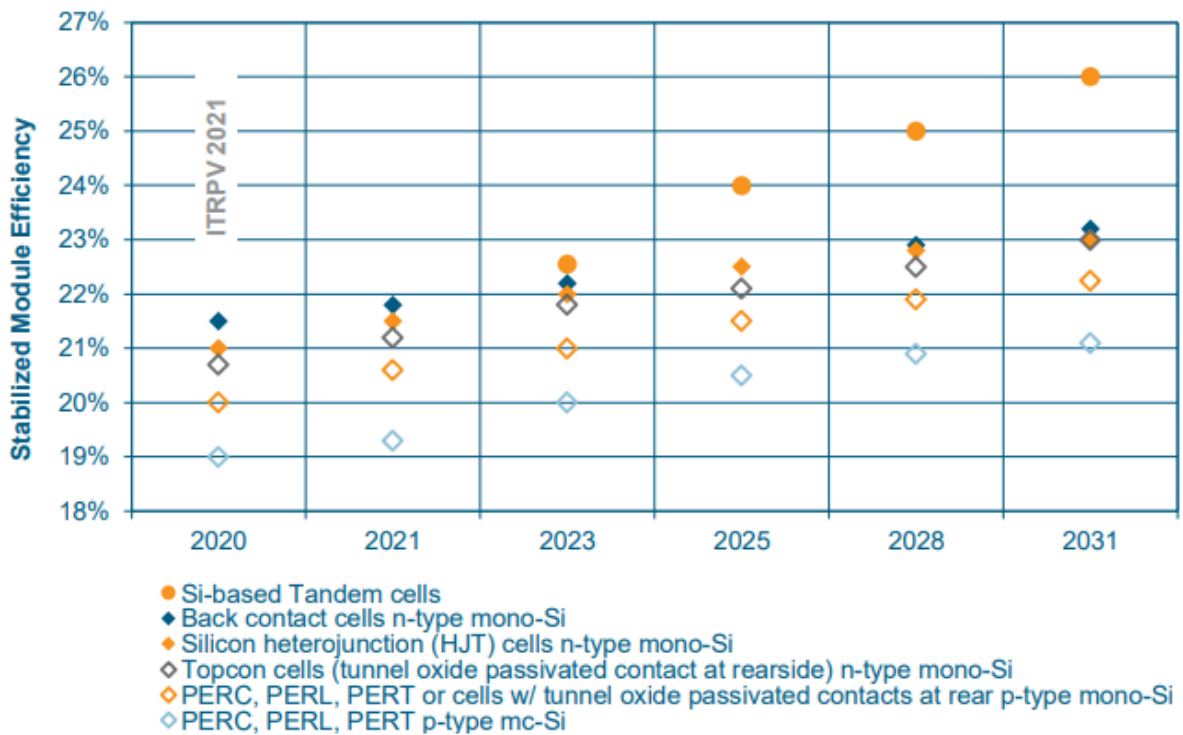

Figure 9 Efficiencies of different cell types (Ref. 9).

Not only the efficiency but also the reliability of PV modules has improved significantly over the last years. Based on extensive research in materials science and accelerated/field tests of components and systems, manufacturers now offer product warranties for materials and workmanship up to 25 years and power warranties with a linear degrading warranty from initially 97% of the peak power value to a level of 87% after 25 years.

Market capacities and sizes

Figure 10 shows the development in installed and registered PV capacity in Denmark for the recent years. The additional installation capacity in 2021 does not contain data of the full year.

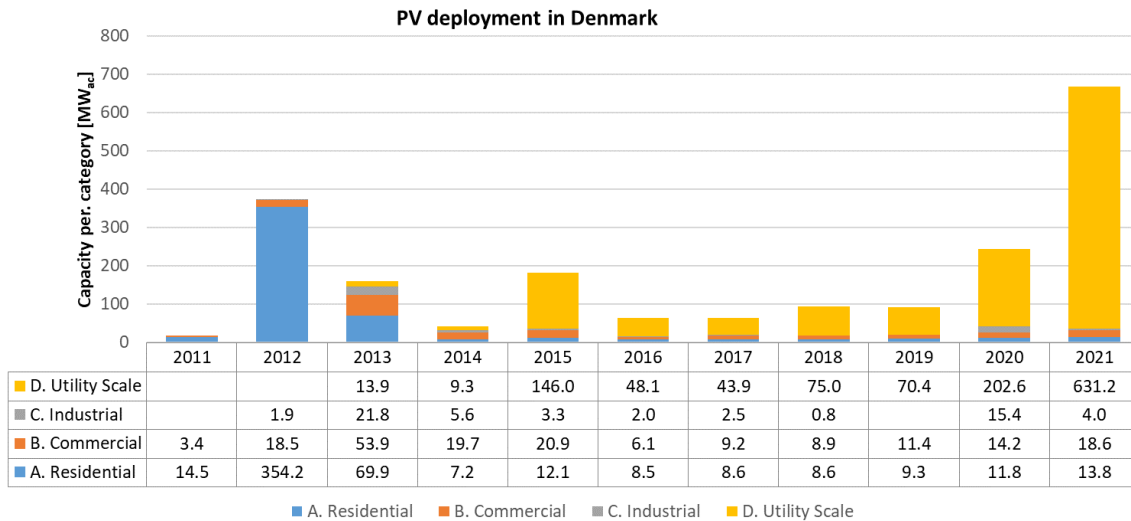
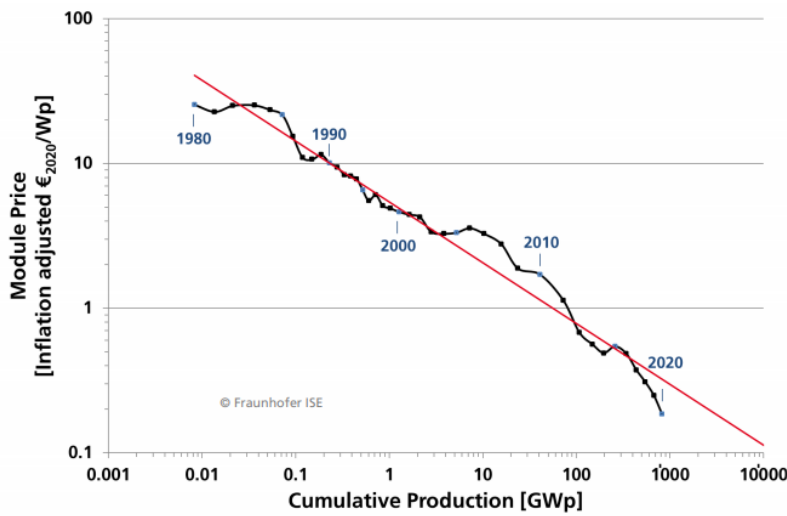

Figure 10 Installed capacity (MW<sub>ac</sub>/year) in Denmark. Based on data from the Danish Energy Agency (Stamdataregister) processed into the following categories: Residential <10, Commercial <250, Industrial <1000 and Utility scale >1000 kW. Data processed by categorizing and addition of known grid-connected projects that had not been registered in the Stamdataregister

The average yearly installed capacity of residential and commercial roof-based projects have been around 15 MW and unchanged over the last 5 years compared to the utility scale segment, which in 2020 represented 87% of the installed capacity and which rose to 94% in 2021.

**Prediction of performance and costs**

Predictions about the future investments costs of PV panels can be made by looking at the past development in prices and global capacity. Learning rates describe the cost reductions achieved when the accumulated capacity is doubled. For most technologies, learning rates vary between 5 and 25% meaning that a doubling of accumulated capacity results in a 5 to 25% cost reduction. The precise learning rates of PV components such as inverter, substructure, EPC, transformer, cables and other grid related costs are difficult to estimate as these components have been on the market for many decades and global production records are thereby hard to come by. However, it is reasonable to assume a low learning rate for these components. The learning rate of PV modules however was in average 25% from 1980 to 2020, shown in Figure 11.



**Learning Rate:**  
 Each time the cumulative PV module production doubled, the price went down by 25% for the last 40 years.

Figure 11 Historic learning rate of PV modules (Ref. 9). Note that average module prices increased in 2021 to around 0.21 €/Wp due to a raw material scarcity.

The module price has decreased from 24-26 €<sub>2015</sub> per W<sub>p</sub> in 1980 to about 0.21 €<sub>2015</sub> per W<sub>p</sub> in 2020. The tendency of Figure 11 shows a strong correlation between cumulative production and price reductions. This tendency is projected to continue in the future.

The typical component shares of the total investment cost for a utility scale plant are shown in Table 3.

Table 3 Component cost shares of utility scale PV systems.

| Component                                | Share of total cost |
|--|---------------------|
| Module                                   | 45.7%               |
| Inverter                                 | 5.5%                |
| Transformer and grid connection          | 10.9%               |
| Installation                             | 22.7%               |
| Soft costs <sup>16</sup>                 | 6.5%                |
| Other costs, mark up & contingency costs | 8.7%                |
| <b>Total</b>                             | <b>100%</b>         |

Table 3 shows that module and inverter prices accounts together for 52% of the total investment costs, while transformer, grid connection, installation costs, soft costs and other costs are 48% of the total costs.

The cumulative global PV capacity installed is around 738 GW, as of 2020 (Ref. 46). While future estimates vary, the IEA Announced Pledges Scenario 2021 estimates a PV capacity of approx. 9,100 GW of capacity by 2050. This scenario

<sup>16</sup> The soft cost includes permits, surveys and studies on grid level, geotechnical analysis, legal costs, environmental costs, planning costs.

represents a more conservative development relative to the IEA Net Zero Scenario 2021 where the cumulative global PV capacity is projected to be approx. 14,500 GW in 2050.

Using the capacity projections of the Announced Pledges Scenario 2021, the future component costs can be calculated with respective learning rates, shown in Table 4.

Note that the total investment for 2020 is equivalent to the chapter's previous version from November 2019 inflated into 2020-€ from 2015-€.

**Table 4: Future component costs based on the global solar PV capacity projections of IEA's Announced Pledges Scenario 2021 (WEO 2021).**

| Mio. € - 2020/MW <sub>p</sub>                         | 2020        | 2030        | 2040        | 2050        |
|---|-------------|-------------|-------------|-------------|
| PV module   | 0.21        | 0.11        | 0.08        | 0.07        |
| Inverter  | 0.02        | 0.02        | 0.01        | 0.01        |
| Transformer and grid connection                       | 0.05        | 0.04        | 0.04        | 0.03        |
| Installation  | 0.10        | 0.08        | 0.07        | 0.07        |
| Soft costs  | 0.03        | 0.02        | 0.02        | 0.02        |
| Residual Balance of plant, mark-up & contingency cost | 0.04        | 0.03        | 0.03        | 0.03        |
| <b>Total investment</b>                               | <b>0.45</b> | <b>0.31</b> | <b>0.26</b> | <b>0.23</b> |

Learning rate for PV module and inverter: 25%. Learning rate other components: 10%.

With IEA's Net Zero Emissions by 2050 Scenario projection, the cost reductions become somewhat more aggressive, resulting in a significant lower overall cost by 2050, shown in Table 5. These prices projections also start in with the lowest available price on the 2020 market to represent the most extreme price reduction path.

**Table 5 Future component costs based on the global solar PV capacity projections of IEA's Net Zero Emissions by 2050 Scenario 2021 (WEO 2021).**

| Mio. € - 2020/MW <sub>p</sub>                         | 2020        | 2030        | 2040        | 2050        |
|---|-------------|-------------|-------------|-------------|
| PV module   | 0.20        | 0.09        | 0.06        | 0.06        |
| Inverter  | 0.02        | 0.01        | 0.01        | 0.01        |
| Transformer and grid connection                       | 0.05        | 0.04        | 0.03        | 0.03        |
| BoS and installation                                  | 0.10        | 0.07        | 0.07        | 0.06        |
| Soft costs  | 0.03        | 0.02        | 0.02        | 0.02        |
| Residual Balance of plant, mark-up & contingency cost | 0.04        | 0.03        | 0.03        | 0.02        |
| <b>Total investment</b>                               | <b>0.44</b> | <b>0.26</b> | <b>0.22</b> | <b>0.20</b> |

Both projections suggest that the price development in the future may not be as radical as the historic development, meaning that PV technology can currently, according to the Technology Catalogue guidelines, be classified as a category 3 technology with a large deployment while presumably approaching category 4 around 2030 in terms of price development.



### Efficiency perspectives

Monocrystalline cells have always been more efficient relative to multicrystalline ones as the crystal purity is higher, thereby minimizing recombination losses due to impurities, grain boundaries and dislocations. The efficiency increase of the respective cell types are due to previously mentioned change of the cell architecture and other structural improvements. An example of a structural change is the use of modules with “**half-cut cells**” which reduce the current through the module by a half and thereby the electrical loss by a fourth. In general, the various improvements in cell design and wafer substrate quality are expected to increase the module efficiency to 21% for state of the art 2021 modules.

The maximum theoretical efficiency of c-Si solar PV cells is estimated to be approximately 29%, whereas three-junction solar PV cells can reach up to 49%.

### Uncertainty

As future PV module price projections show further price reductions, there are uncertainties connected to the magnitude and timing of these reductions. Many different factors can influence the future price development such as the raw material cost of different cell types, new structural innovations, national policies and competition with other renewable technologies.

As for silicon-based cell types, the global silicon reserve is estimated to be abundant and thereby able to supply the current demand for many decades (Ref. 18).

An additional uncertainty is with respect to which cell type will be the dominant one in the future market, as the effect of new near-future production methods for monocrystalline cells are yet to be determined. In addition, there is always the possibility that a new cell type emerges and becomes dominant.

### Additional remarks

-

### Quantitative description

See separate Excel file for Data sheet, in which the prices are given in 2020-€.

As the boundary for both cost and performance data in the catalogue is the delivered energy to the electricity grid, all the values presented in the datasheets are referring to the AC grid connection capacity, if not stated specifically or unless stated otherwise. However, due to the strong correlation of many cost elements to the peak power (except for inverters and AC electrical connection) and relevance in the PV sector, the financial data is also presented explicitly as per DC peak power in the bottom of the datasheets.

Note that previous versions of the catalogue in contrast have explicitly stated both subscripts for either AC power or DC peak power in the datasheet for utility scale plants.

### Building integrated PV

In recent years, a large variety of building integrated PV (BIPV) solutions has been developed and commercialized. Solar modules are now available in many different types, expressions and colors allowing them to be integrated aesthetically in both new and existing buildings. Commercial solutions are available for roofs and facades, whereas transparent solar cells, which can serve as windows, are still in the development phase. The website of the IEA Solar heating and cooling program presents a large range of buildings, where solar energy solution forms an integrated part of the architecture [48], and specific BIPV examples are collected in the IEA-PVPS Task 15 framework: <https://iea-pvps.org/wp-content/uploads/2021/03/IEA-PVPS-Task-15-An-international-collection-of-BIPV-projects-compr.pdf>.

Market developments, stakeholder analysis and technological status reports for the BIPV sector are publicly available on IEA PVPS task 15 (<https://iea-pvps.org/research-tasks/enabling-framework-for-the-development-of-bipv/#contacts>) and BIPV boost website (<https://bipvboost.eu/public-reports/>).

The upfront investment in €/W for the building integrated PV solutions is typically significantly higher than traditional PV plants that are mounted on top of an existing roof, or façade systems. However, the advantage of the building-integrated solutions is that they form part of the building's envelope, thereby replacing investments in façade or roof cladding. The actual additional cost €/W by choosing the solar solution is therefore significantly lower. BIPV solutions are replacing conventional building materials and thus the price pr m<sup>2</sup> is also a key performance indicator.

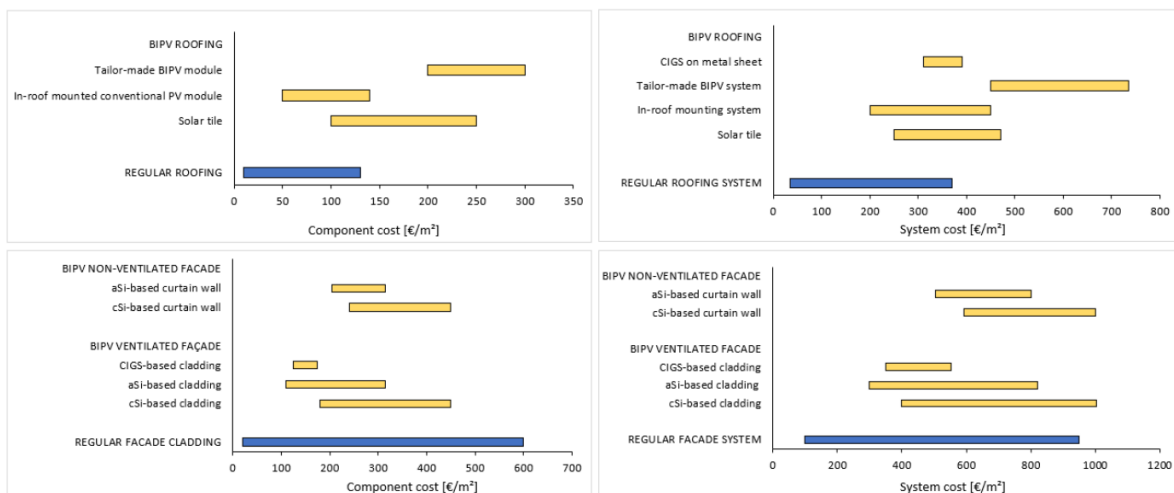

Figure 12: Cost range of BIPV systems compared to conventional counter parts in the literature (Ref 49)

It is thus recommended for new construction projects and renovation projects to evaluate the feasibility based on the additional costs and benefits and further a BIPV installation contributes to the energy frame of a building to a certain extent (BR18), and contribute to creating nearly zero energy buildings as required via the EU energy performance directive (2018/844/EU) .

The additional costs of BIPV depends on which roof or façade solution the building owner would otherwise have chosen, which again reflects the aesthetic preference of the owner of the building. For those reasons the data sheets in the current technology catalogue do not include information on building integrated PV. However, to provide overall guidance on the competitiveness of BIPV solutions, the present section includes select data for building integrated solutions available in the Danish market today (2021). We focus on rooftop solutions because a number of standardized solutions are available in this segment and limit the scope to a detached house with a roof surface of 160 m<sup>2</sup>.

Typically, the capacity per  $m^2$  is lower for building integrated solar panels, because other factors, such as aesthetic and endurance, are weighted higher in the design of the solution. For the building-integrated roofing solutions sold on the Danish market, the capacity per  $m^2$  is typically between 70 and 175  $W/m^2$  against 190 to 200  $W/m^2$  for traditional roof-top PV solution. In some cases, the reason for the lower capacity per  $m^2$  is poorer efficiency of the solar cells, addition of a coloration layer, whereas in other cases the lower output is explained by the fact that the building integrated solar solutions contains of a mix of active and inactive materials.

Table 6 provides an overview of the cost of different roofing solutions with and without BIPV for a building with a 160  $m^2$  roof. The additional cost of BIPV roof solutions varies between approximately zero, when comparing a low-capacity BIPV solution (74  $W/m^2$ ) with a tile roof, and about 23,000 € when the high capacity BIPV solution (175  $W/m^2$ ) is compared to for example a steel roof. The low-capacity solution is estimated to typically generate about 8,500 kWh annually, whereas the high-capacity solution is expected to generate just above 18,000 kWh. Actual generation figures for BIPV roof solutions obviously depend on the inclination and direction of the roof.

**Table 6: Approximate cost of different roofing solutions with/without BIPV for a 160  $m^2$  roof. The figures include estimates of the cost of installation for a typical building. (Ref. 45)**

| Roof solutions           | Estimated cost incl. installation, excl. VAT, €-2020 | PV capacity (kW) | Estimated annual generation (kWh) according to supplier |
|--------------------------|--|------------------|---|
| BIPV, steel, 74 $W/m^2$  | 24,300   | 11               | 8,500   |
| BIPV, steel, 175 $W/m^2$ | 38,200   | 26               | 18,169  |
| Tile roof                | 23,700   |                  |   |
| Steel roof               | 14,400   |                  |   |
| Asphalt roofing          | 12,500   |                  |   |
| Fibre (cement) roof      | 13,000   |                  |   |

Coloration of PV panels:

PV panels can be colored by adding a coloration layer in front of the the solar cell, and the coloration is created by reflecting a disired mix of wavelengths to an observer. The reflected wavelengths are not contributing to powerproduction and thereby reducing efficiency. Approximately 50 % of the AM 1.5 solar spectrum absorbed by a silicon solar cells is visible light, and most of the remaining is near infrared light. Theoretical studies prove that coloration using reflective filters can match all RAL colors from the RAL color chart with an efficiency loss of less than 20 % and 10 % for most colors except white colortones (Ref 50), and the ideal solar cell for coloration with the highest achievable cell efficiency is a cell with a bandgap of 1.15 eV to 1.135 eV close to the one of crystalline silicon of 1.12 eV (Ref 51). Practical realization on a large scale of these idealized filters has still to be proved.

Comercially two major types of coloration techonologies are available. Pigments based coloration where a pigments base layer in the front of the solar cell is providing the color by absorption of light, using e.g. colored glass. Typically acceptable color saturation can be achieved with a 20-30 % efficiency loss, and the color is generally angle independent. (Ref 52)

The other major color techology is use of optical filters reflecting specific wavelengths and this shows an angle depended color, limited color availability and limited color saturation but have a low efficiency loss for coloration of less than 10 %.(Ref 52, commercial actors Swissinso and LOF solar) Diffusse glasses reduces the angular color dependence.

Glare from PV can also be reduced using satinized glass and similar surface treatments, and thus a toolbox for solving challenges in relation to the build environment is available.

### References

1. NPD Solarbuzz PV Equipment Quarterly report, July 2013.
2. Berkeley Lab, Utility-Scale Solar. Empirical Trends in Project Technology, Cost, Performance, and PPA Pricing in the United States – 2018 Edition
3. IEA, "Energy Technology Perspectives. Technology Roadmap: Solar Photovoltaic Energy, 2014 edition", OECD/International Energy Agency, 2014.
4. Peter Riddersholm Wang, DMI Teknisk Rapport 13-08, Referenceværdier: Månedsværdier og årsværdier for stationer 2001 - 2010, Danmark for temperatur, relativ luftfugtighed, vindhastighed, globalstråling og nedbør.
5. ITRPV. International Technology Roadmap for Photovoltaic, Results 2013. March 2014.
6. Thibaut Lemonie. Assessing the real quality of PV modules. Photovoltaics Int. Aug 2011, p. 177.
7. Nicholas Riedel-Lyngskær et al. Validation of Bifacial Photovoltaic Simulation Software against Monitoring Data from Large-Scale Single-Axis Trackers and Fixed Tilt Systems in Denmark. Appl. Sci. 2020, 10, 8487; doi:10.3390/app10238487.
8. "Solceller: Dansk strategi for forskning, udvikling, demonstration.". EUDP. 2016
9. "Photovoltaics report". Fraunhofer. 2020.
10. "Renewables 2018". IEA. 2018.
11. Magsun Solar. (2019). Downloaded from <http://www.solarenergy86.com/en/showpro.php?id=143>
12. Array Technologies. (2019). Downloaded from <https://arraytechinc.com/>
13. PV Tech. (4. Juli 2017). Hentet fra <https://www.pv-tech.org/products/helioslites-disruptive-1.5-axis-pv-tracker>
14. "Global Market Outlook 2018-2022". Solar Europe. 2018.
15. Soltec. (2019). Downloaded from <https://soltec.com/>
16. "Preliminary report". IEA-PVPS. 2019.
17. "New Policies Scenario". IEA. 2018.
18. "Silicon"- annual publication. US Geological Survey. 2019.
19. "ITRPV 10th edition" annual report. ITRPV. 2019.
20. "Mono will supply 80% of the world's solar by 2021.", PV Magazine
21. Joshua S. Stein et al. Bifacial Photovoltaic Modules and Systems: Experience and Results from International Research and Pilot Applications. IEA-PVPS T13-14:2021
22. NREL, U.S. Solar Photovoltaic System Cost Benchmark, Q1 2018, <https://www.nrel.gov/docs/fy19osti/72133.pdf>
23. Bloomberg New Energy Finance, 2019
24. "Impact of weighted average cost of capital, capital expenditure, and other parameters on future utility-scale PV levelised cost of electricity", ETIP PV, August 2019.
25. Ubiquity Solar Inc. 2012, Extrapolation of PV module experience curve.
26. ITRPV. International Technology Roadmap for Photovoltaic, Results 2013. March 2014 for 2015 cost.

27. Prices from Solcellepriser.dk, pricelist small plants 15 cheapest plants used.
28. Web search by Jan Vedde November 2014 Prices for seven small plants for sale in DK in November 2014 for 2015 cost.
29. David Feldman et al. Photovoltaic System Pricing Trends, Historical, Recent, and Near-Term Projections edition 2014. SUNSHOT U.S. Department of Energy, National Renewable Energy Laboratory and Lawrence Berkeley National Laboratory , September 22, 2014
30. Renewable Power Generation Costs in 2017, IRENA, January 2018
31. Cost development of low carbon energy technologies, Scenario-based cost trajectories to 2050, 2017 edition, Tsiropoulos, I. Tarvydas, D., Zucker, A., JRC, January 2018.
32. IEA-ETSAP and IRENA Technology Policy Brief E11, January 2013.
33. HOFOR plan, plant in Guderup (web search) and 2 other plants (anonymous, Jan Vedde 2014) all 4 large and DK.
34. <http://www.photovoltaiik-guide.de/pv-preisindex>, "Photovoltaik-preisindex" PV system up to 100 kWp, average 2014. *for 2015 cost*
35. Prices for nine large and medium size systems 2013-2014(Confidential) *for 2015 cost*
36. Gaia solar, BIOFOS Rensningsanlæg Damhusåen, large system 2013 *for 2015 cost*
37. Gaia solar general offer 250 kW system 2014 *for 2015 cost*
38. Anonym DK EPC#1 offering 0.91 2014-€/Wp for MW projects in DK *for 2015 cost*
39. Anonym DK EPC#1 offering 0.95 2014-€/Wp for MW projects in DK *for 2015 cost*
40. Sales representatives from 5 suppliers (in random order): Changzhou EGing Photovoltaic Technology Co., Ltd., China Sunergy (Nanjing) Co. Ltd., Trinasolar, ZNSHINE PV-TECH CO., LTD., Elkem Solar
41. Solar-installation companies' websites 1.-5. March 2018: <https://www.vivaenergi.dk>, <https://xn--billigtsolcelleanlg-2xb.dk>, <https://klimaenergi.dk>
42. Gernot Oreski, Jan Vedde et al. Designing new materials for photovoltaics: Opportunities for lowering cost and increasing performance through advanced material innovations. IEA-PVPS-T13-13 2021.
43. Jan Vedde. Evaluation of tracker technology in the Northern Hemisphere. TaiyangNews Virtual Conference on Solar Trackers – How to Follow The Sun Optimally To Maximize Yield Of Utility-Scale PV System. March 10<sup>th</sup> 2021.
44. PV magazine. Reusing PV modules poses opportunities and challenges. March 8<sup>th</sup> 2021. <https://www.pv-magazine.com/2021/03/08/reusing-pv-modules-poses-opportunities-and-challenges/>
45. <https://bomagasinet.dk/nyt-tag-pris/> , [https://www.nyt-tag.com/#Prov\\_vores\\_pris\\_beregner\\_pa\\_nyt\\_tag\\_her](https://www.nyt-tag.com/#Prov_vores_pris_beregner_pa_nyt_tag_her) <https://www.bolius.dk/nyt-tag-til-parcelhuset-16771>, <https://yellowtec.dk/produkter/solcelletagsten-integreret-solcelletag/> <https://solartag.eu/> <https://ennogie.com/da/>. Accessed August 2021, personal communication with Ennogie, august 2021.
46. "World Energy Outlook". IEA. 2021. <https://www.iea.org/reports/world-energy-outlook-2021>
47. "Life Cycle Assessment of Electricity Generation Options". UNECE. 2021
48. <http://task41casestudies.iea-shc.org/>
49. Becquerel Institute "BIPV SOLUTIONS IN EUROPE: COMPETITIVENESS STATUS & ROADMAP TOWARDS 2030 – WHITE PAPER" <https://bipvboost.eu/public-reports/download/bipv-solutions-in-europe-competitiveness-status-ro>
50. G. Peharz, A. Ulm "Quantifying the influence of colors on the performance of c-Si photovoltaic devices" Renewable Energy 129 (2018) 299e308
51. J. Halme, P. Mäkinen "Theoretical efficiency limits of ideal coloured opaque photovoltaics" Nergy Environ. Sci. vol. 12, no 4 pp 1274-1285, 2019, DOI: 10.1039/c8ee03161d
52. M. Babin, A.A. Santamaria Lancia, A. Thorseth, S. Thorsteinsson "Characterisation of Angular Dependent Optical Properties of Different Coloring Technologies Employed in BIPV Products", EUPVSEC 2020 pp 1136-1142; 10.4229/EUPVSEC20202020-4AV.2.32

## 23 Wave Energy

There are no plans to update this chapter.

This chapter has been moved from the previous Technology Data Catalogue for Electricity and district heating production from May 2012. Therefore, the text and data sheets do not follow the same guidelines as the remainder of the catalogue.

### Brief technology description

A wave power converter comprises a structure interacting with the incoming waves. The wave power is converted by a Power Take-off (PTO) system based on hydraulic, mechanical or pneumatic principles driving a rotating electrical generator producing electricity or by a linear generator directly driven by the structure.

Numerous concepts are under development. Most of them can be classified according to three categories (ref. 2):

A *point absorber* is a floating device, moved up and down by the waves, typically anchored to the sea floor.

A *terminator* is a structure located perpendicular to the wave movement, 'swallowing' the waves

An *attenuator* is placed in the wave direction, activated by the passing waves.

There is no commercially leading technology on wave power conversion at the present time. However a few different systems are presently at a stage of being developed at sea for prototype testing or developed at a more fundamental level including tank testing, design studies and optimisation.

### Input

Energy in ocean waves.

The energy content along Europe's Atlantic coasts is typically 40-70 kW/m. The wave influx in the Danish part of the North Sea is 24 kW/m farthest West, 7 kW/m nearer the coast, in average about 15 kW/m. The inner seas are irrelevant with only 1 kW/m (ref. 2).

The annual variation is normally within +/- 25%, while the seasonal variation is around 5:1, with highest potential during winter (ref. 2).

### Output

Electricity.

Some systems are designed to pump water and produce potable water.

### Typical capacities

The electrical output from wave power converters in some cases are generated by electrical connected groups of smaller generator units of 100 – 500 kW, in other cases several mechanical or hydraulically interconnected modules supply a single larger turbine-generator unit of 1 – 3 MW. These sizes are for pilot and demonstration projects. Commercial wave power plants will comprise a large number of devices, as is the case with offshore wind farms.

### Regulation ability

The ability to regulate the system operation depends on the design of the PTO system. In general the systems are developed with the aim of regulating the system to absorb most of the incoming waves at a given time, but also to enable disconnection of the system from the grid if required for safety or other reasons.

Wave power is more predictable compared to wind power and the waves will continue some time after the wind has stopped blowing. This could help increase the value of systems with combined wind and wave power.

### Advantages/disadvantages

Advantages:

- Wave power converters produce power without the use of fossil fuels.

- The power plants are located in the ocean without much visual intrusion.
- Wave power is a more predictable resource compared to wind.
- Extracting energy from waves can help coastal protection, as the wave heights are reduced

#### Disadvantages:

- The initial prototype development at sea is costly and the successful development to reach costs comparable with i.e. off shore wind will require dedicated development programmes and substituted electricity prices until the technology has matured.
- In Denmark, the largest wave energy resource is found 150 km from the shore, making grid connection only feasible for large wave energy farms.
- Wave power converters, albeit at sea, take up large amounts of space, much dependent on type of converter and how much power is extracted. It is too early to tell, whether wave power will require more or less space than offshore wind power (ref. 7).

#### Environmental aspects

As for wind-energy a positive life cycle impact is expected. Planned in cooperation with navigation, oil exploitation, wind farms and fishing industry wave power plants are expected to have a positive impact on the living conditions for fish in the sea, by providing sheltered areas.

#### Research and development

The most recent Danish R&D strategy (ref. 3) has three focus areas:

- Continue the development and demonstration of concepts that have already proven a technical and economical potential.
- Support R&D in new concepts with promising perspectives.
- Evaluate most feasible sites, assess ways of safe anchoring, and determine how wave energy is best integrated into the Danish electricity system.

#### Examples of best available technology

It is too early to define best available technologies, since numerous technologies are being tested and demonstrated. Recent reviews have identified about 100 projects at various stages of development, and the number does not seem to be decreasing. Most concepts are described in ref. 5. This includes the most mature Danish technologies: Wave Star, Wave Dragon, Poseidon Floating Power Plant, Waveplane, Dexta.

By 2009, several plants with an individual turbine/generator capacity of up to 0.7 MW have been demonstrated (ref. 6).

Scotland and Portugal are very active in developing wave energy. Portugal had a goal of having 23 MW capacity installed by end of 2009. The first plant consisted of 3 Pelamis wave devices ([www.pelamiswave.com](http://www.pelamiswave.com)), each 750 kW, installed in 2008 (ref. 1 and 2). However, due to financial problems for one of the investors, the plant was not in continuous operation end of 2009 (ref. 4).

National targets in Europe (ref. 9):

|                 |                |
|-----------------|----------------|
| United Kingdom: | 0.3 GW in 2020 |
| Ireland:        | 0.5 GW in 2020 |
| France:         | 0.3 GW in 2015 |
| Spain:          | 0.2 GW in 2015 |

Portugal: 0.3 GW in 2020

#### Additional remarks

A cost breakdown of a typical mature ocean energy project is as follows (ref. 1):

|                                      |     |
|--------------------------------------|-----|
| Site preparation:                    | 12% |
| Civil works:                         | 55% |
| Mechanical and electrical equipment: | 21% |
| Electrical transmission:             | 5%  |
| Contingencies:                       | 7%  |

Such a breakdown depends much on the chosen system and ocean location i.e. water depth and distance to shore. Energinet.dk has developed a spreadsheet to estimate the cost of energy (ref. 8).

#### References

- [1] "Energy Technology Perspectives 2008", International Energy Agency, 2008.
- [2] "Ressourceopgørelse for bølgekraft i Danmark" (Wave energy resources in Denmark), Aalborg University for the Danish Commission on Climate Change Policy, May 2009.
- [3] "Bølgekraftteknologi. Strategi for forskning og udvikling" (Wave power technologies. Strategy for R&D; in Danish); Danish Energy Agency and Energinet.dk, June 2005.
- [4] Aalborg University, Department of Civil Engineering, November 2009.
- [5] International Energy Agency Implementing Agreement on Ocean Energy Systems (IEA-OES; [www.iea-oceans.org](http://www.iea-oceans.org)), Annual Report 2008.
- [6] "State of the art analysis", status report of the Waveplam project, February 2009.  
[www.waveplam.eu/files/downloads/SoA.pdf](http://www.waveplam.eu/files/downloads/SoA.pdf)
- [7] DONG Energy, December 2009.
- [8] [www.energinet.dk/DA/KLIMA-OG-MILJOE/Energi-og-klima/Forskning-i-vedvarende-energi/Sider/Boelgekraft.aspx](http://www.energinet.dk/DA/KLIMA-OG-MILJOE/Energi-og-klima/Forskning-i-vedvarende-energi/Sider/Boelgekraft.aspx)
- [9] [www.eu-oea.com/euoea/files/ccLibraryFiles/Filename/000000001047/Cover%20letter%20position%20paper\\_merged.pdf](http://www.eu-oea.com/euoea/files/ccLibraryFiles/Filename/000000001047/Cover%20letter%20position%20paper_merged.pdf)



## Data sheet

|  | Wave Power |           |          |          |      |         |
|--|------------|-----------|----------|----------|------|---------|
|  | 2015       | 2020      | 2030     | 2050     | Note | Ref     |
| <b>Energy/technical data</b>                     |            |           |          |          |      |         |
| Generating capacity for one power plant (MW)     | 1.0 - 30   | 2.0 - 50  | 10 - 100 | 50 - 500 |      | 1;1;4;4 |
| Length of installation of one power plant km     | 0.2 - 2    | 0.2 - 5.0 | 1 - 20   | 5 - 100  |      | 1;1;4;4 |
| Annual generated electricity production (MWh/MW) | 1500       | 2500      | 3500     | 4500     |      | 4       |
| Availability (%)                                 | 90         | 95        | 97       | 98       |      | 4       |
| Technical lifetime (years)                       | 10         | 20        | 25       | 30       |      | 4       |
| Construction time                                | 3 - 4      | 3 - 4     | 3 - 4    | 3 - 4    | C    | 4       |
| <b>Financial data</b>                            |            |           |          |          |      |         |
| Nominal investment (M€/MW)                       | 4.6-11     | 3.8-9.0   | 2.2-4.5  | 1,6      | A+B  | 2;2;2;3 |
| O&M (€/MWh)                                      | 20         | 15        | 10       | 7        |      | 4       |
| O&M (€/kW/year)                                  | 85         |           |          | 47       |      | 3       |

## References

- [1] Wave Net final report, Project no. ERK5 – CT –1999-20001 (2000 - 2003)
- [2] “Energy Technology Perspectives 2008”, International Energy Agency, 2008.
- [3] “Energy Technology Perspectives 2010”, International Energy Agency, 2010.
- [4] Danish Wave Energy Association, 2012

## Notes:

- A The cost presented provides an estimate for what capital cost and operating costs of wave power converters might be in the future assuming all R&D challenges have been overcome, that economics of scale have been realized and that efficiencies in production and operation due to the learning curve effect have been achieved.
- B Cost data are the same as in the 2010 catalogue, however inflated from price level 2008 to 2011 by multiplying with a general inflation factor 1.053
- C Much dependent on plant size and location.

## 40 Heat pumps

### Contact information:

Danish Energy Agency: William Vergo, Filip Gamborg

Author (air-water, excess heat and ammonia seawater heat pump): Bjarke Paaske, PlanEnergi

Author (chapter review, updated seawater ammonia heat pump and seawater CO<sub>2</sub> heat pump): Troels Bruun Hansen, Tobias Lynggaard, Rambøll

### Amendments after publication date

| Date         | Ref. | Description   |
|--------------|------|---|
| June 2022    |      | Seawater heat pump updated with infrastructure costs and seawater CO <sub>2</sub> heat pump added             |
| April 2020   |      | Updated qualitative description and datasheets. Datasheets now divided into 3 types and different plant sizes |
| January 2018 |      | Updated prices for auxiliary electricity consumption in the datasheet   |
| August 2016  |      | First published   |

## Qualitative description

### Brief technology description

Heat pumps employ the same technology as refrigerators, moving heat from a low-temperature level to a higher temperature level. Heat pumps draw heat from a heat source (input heat) and convert the heat to a higher temperature (output heat) through a closed process; either compression type heat pumps (consuming electricity or fuels) or absorption heat pumps (using heat; e.g. steam, hot water or oil). There exist many different variations of heat pumps that can overall be divided as below (or combinations).

- Compression heat pumps, using electricity
- Compression heat pumps, using a combustion engine
- Absorption heat pumps, direct fired/indirect fired

An important point regarding heat pumps is the ability to “produce” both heating and cooling. When applied with the primary purpose of cooling, the cooling demand defines the capacity. A heat pump with combined heating and cooling can utilize different heat sources in combination e.g., cooling demand and wastewater. The combined solution will often be efficient because it can increase the number of full load hours for the heat pump compared to only combined heating and cooling. The primary purpose of the heat pumps in the technology catalog is heating. In this chapter, the unit MW is referring to the heat output (also MJ/s) unless otherwise noted.

Heat pumps are generally a well-known technology that has been widely used for large-scale refrigeration.

Heat pumps can utilize several different heat sources. Due to recent development in heat pump utilization at DH plants, this chapter primarily focuses on electrically driven compression heat pumps. These heat pumps can utilize several

energy sources e.g. air, groundwater, seawater, wastewater, drinking water, district cooling, geothermal heating, and excess heat from industrial processes or data centers.

Large scale heat pumps are often designed after the size of the heat source available and due to high specific investment costs, a high number of full load hours are required to make a feasible business case. Therefore is, large-scale heat pumps often designed for baseload rather than peak load. The application of large heat pumps in DH systems in Denmark may influence the development of the heat pumps globally – both the technology itself and the application. This is contrary to small-scale heat pumps, where the Danish market is small compared to other markets, and therefore is not expected to influence the overall development of small-scale heat pumps.

The focus of this chapter is the most relevant current applications in Danish DH systems (2021). These are:

- Compression heat pumps utilizing ambient air (1, 3 and 10 MW)
- Compression heat pumps utilizing industrial excess heat (1, 3 and 10 MW)
- Compression heat pumps utilizing seawater (20 and 65 MW)
- Absorption heat pumps (12 MW)

The implementation of compression heat pumps is currently accelerating rapidly. Compression heat pumps utilizing ambient air can be installed virtually anywhere, and where a source is available, industrial excess heat can be utilized to decrease energy consumption. Compression heat pumps utilizing seawater can be implemented at larger central DH systems soon e.g. in Esbjerg and Aalborg.

Heat pumps utilizing industrial excess heat most likely yield lower heat production costs because the higher source temperature results in a high coefficient of performance (COP). Utilization of excess heat can also be beneficial for the industrial sector since it can reduce energy or water consumption at cooling towers etc. Heat pump systems are primarily relevant for processes with high energy consumption and a large number of operating hours.

Excess heat is typically utilized by connecting existing cooling systems to a heat pump meaning that it removes heat from cooling water or glycol and replaces the operation of chillers, cooling towers or gas coolers. Heat pump systems for such applications are relatively simple to install and the main obstacle is often the distance between the cooling water and the DH system. In most cases the heat pump is connected in series or parallel to the existing cooling systems and the redundancy of the cooling system is thereby increased. The heat pump covers the base load of the cooling demand whereas the existing cooling plants will be back up or peak load units thus increasing the safety of operation. It is important to assess the simultaneity of the cooling and heating demand. Often cooling demand is largest during summer, whereas heating demand is largest during winter. In some cases, excess heat may be released at higher temperatures that allow direct heat exchange, which should be done before using a heat pump for further cooling. This is beyond the scope of this chapter.

For drying processes, most of the surplus heat leaves through moist ventilation air, and there is, therefore, no direct cooling demand. In such applications, excess heat can be recovered by cooling and dehumidifying the ventilation air as it leaves the process. This requires cooling surfaces at the exhaust from the ventilation system, which is typically more complex than a heat pump utilizing excess heat from cooling water.

Only smaller seawater pilot plants are installed in Denmark at the moment. It is however expected that larger plants may be installed as a supplement at existing central power plants. This is because large-scale seawater heat pumps can profitably be placed at existing CHP plants. Here the heat pump can take advantage of the existing infrastructure of the CHP plant, such as the direct connection to the DH and power grid. The capital expenditures can be significantly lowered if the heat pump can be integrated into the infrastructure of the existing CHP. However, a large-scale seawater heat pump can also be profitable without the infrastructure of the CHP. The location of the seawater heat pump also depends

on the local seawater conditions. This includes the salinity, temperature, and depths. The local seawater temperatures and salinity influence the COP of the system and the annual number of operating hours [20], [21].

Seawater heat pumps are explained further in the section Seawater Heat Pumps.

### Compression heat pumps

For compression heat pumps, the heat output is usually 3 to 5 times the utilized electricity input (or drive energy). This relation is referred to as the coefficient of performance (COP). The attainable COP depends on the efficiency of the specific heat pump, the temperature of the heat source and sink, and the temperature difference between the heat source and sink (e.g. energy source and district heating temperature). The energy flow is illustrated in the Sankey diagram in Figure 1.

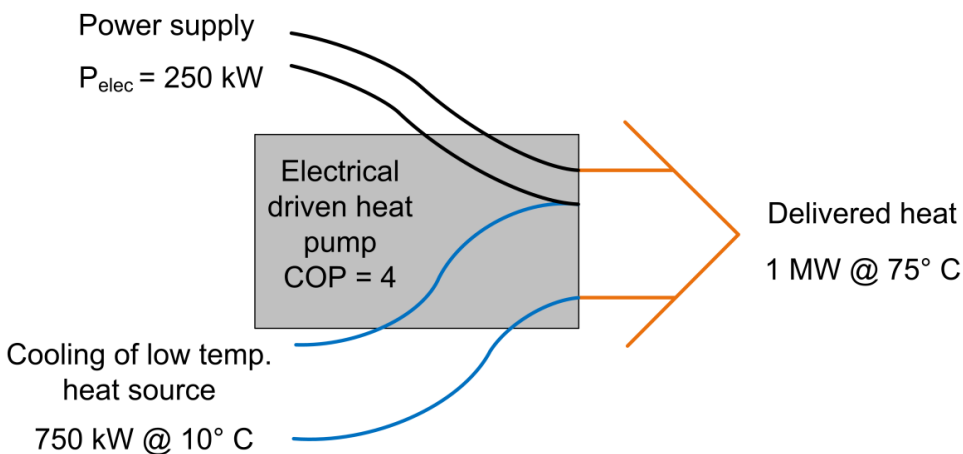

**Figure 1** The electrical power consumption of 250 kW enables the heat pump to utilize 750 kW from a low-temperature heat source at 10 °C. Thus delivering 1 MW at 75 °C (COP is 4).

A general heat pump cycle is shown in Figure 2. For a heat pump that delivers DH, the source could be ambient air or a cooling stream from an industrial process, while the sink could be a flow of the DH return water, at e.g. 40 °C being heated to a higher temperature. The evaporator and condenser are heat exchangers that allow heat exchange, while separating the refrigerant from the source- and sink liquids.

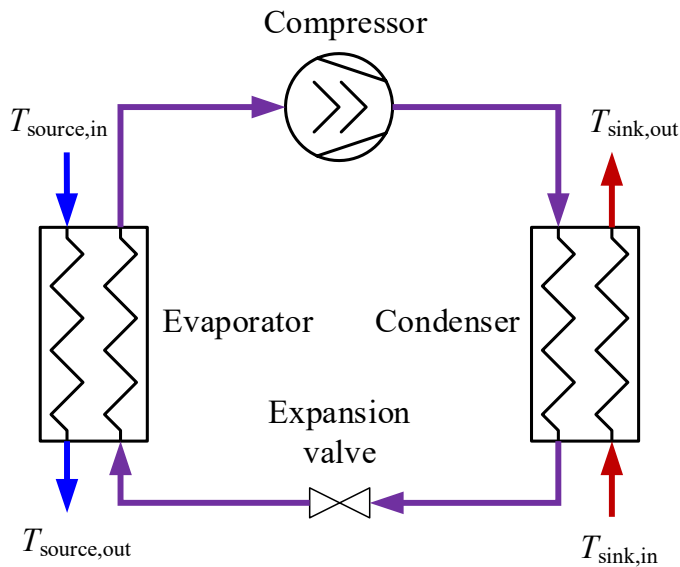

Figure 2 Sketch of the heat pump cycle with components. The Lorenz COP is the theoretical maximum. (Source: Original figure from Bach (2014) “Integration of heat pumps in Greater Copenhagen”).

### COP calculation

The theoretical COP can be calculated as the “Carnot COP” or “Lorenz COP” which relates mechanical work to temperature differences in power generation, refrigeration and heat pump technology. Carnot regards a single refrigeration cycle with one condenser and one evaporator and relates mechanical work to the temperature difference between the condenser and evaporator. The Lorenz calculation method is preferable for “stepped” Carnot cycles, where heating and/or cooling are done in several steps, which is the case for DH, with a temperature increase of 30-50 K. With such high-temperature increases, a heat pump system typically includes several condensers in series meaning that the system consists of several Rankine cycles. The Lorenz cycle is preferable to Carnot in this context, as this includes more steps in the cycle. The equation for Lorenz COP is shown in equation 1 below.

$$\text{COP}_{\text{Lorenz}} = \frac{T_{\text{lm,sink}}}{T_{\text{lm,sink}} - T_{\text{lm,source}}} \quad , \quad \text{where} \quad T_{\text{lm}} = \frac{T_{\text{in}} - T_{\text{out}}}{\ln\left(\frac{T_{\text{in}}}{T_{\text{out}}}\right)} \quad (1)$$

Where  $T_{\text{lm}}$  is the log mean temperature of the source- and sink heat exchangers. Temperatures should be inserted as an absolute temperature, e.g. Kelvin.

Accordingly, a heat pump that heats water from 45 to 85 °C (DH) and cools a source from 20 to 15 °C (cooling water from a factory), will have a Lorenz COP of 7.2. In practice though, the COP will be lower due to mechanical and thermal losses, typically around 40-60 % of the theoretical COP. The relation between practically attainable and theoretical COP, given in equation 2, depends on component efficiencies, heat exchangers, refrigerants and more.

$$\text{COP}_{\text{real}} = \text{COP}_{\text{Lorenz}} \cdot \eta_{\text{Lorenz}} \quad (2)$$

All COP values stated in this chapter are practically attainable values if nothing else is stated.

Figure 3 shows the dependency between COP and source temperature for two systems with different sink temperature requirements ( $T_{\text{sink,in}}$  and  $T_{\text{sink,out}}$ ), i.e. the figure shows practically attainable COP-values and how this is influenced by the source and sink temperatures. The values are calculated with a heat source that is cooled 5 °C – e.g. a heat source of  $T_{\text{source,in}} = 30$  °C is cooled to  $T_{\text{source,out}} = 25$  °C. In this example, the Lorenz efficiency is fixed at 50 %. Increasing the cooling of the heat source (lower  $T_{\text{source,out}}$ ) will lead to a lower COP, but a higher output capacity, since more energy is moved.

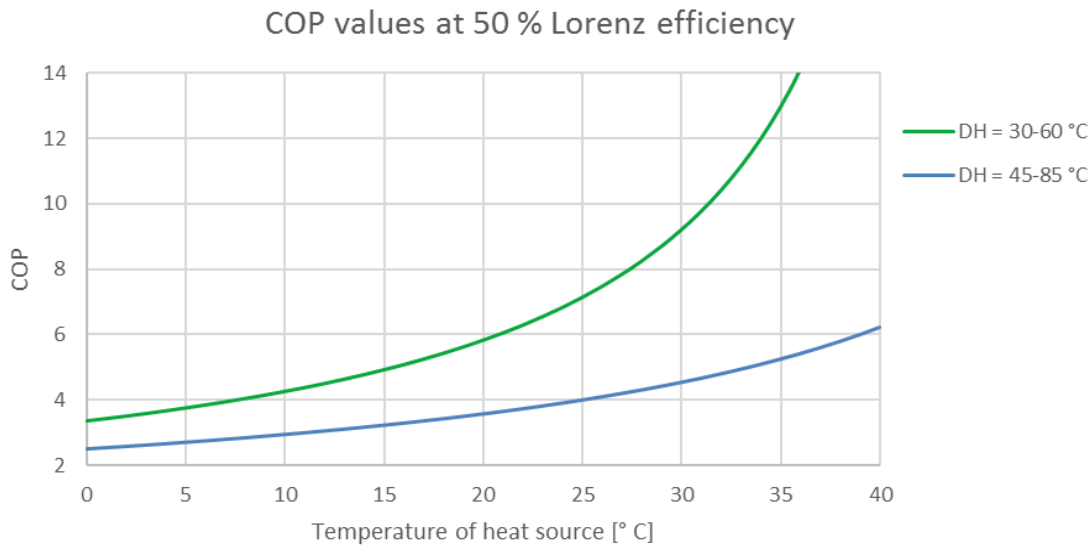

Figure 3 Attainable COP values of a compression heat pump with varying heat source temperatures at two different sink requirements.

As the figure shows, temperatures of both sink and source have a great influence on the COP of compression heat pumps. This is also regardless of the efficiency of the heat pump itself. It follows that heat pumps are most suited for low DH temperatures combined with high-temperature sources. The output heat capacity is also affected by the temperatures, especially the source temperature. This is a result of lower evaporating pressure, meaning that the refrigerant gas is less dense at low temperatures. Figure 4 below, shows the cooling capacity of a specific compressor with a swept volume of 1,000 m<sup>3</sup>/h.

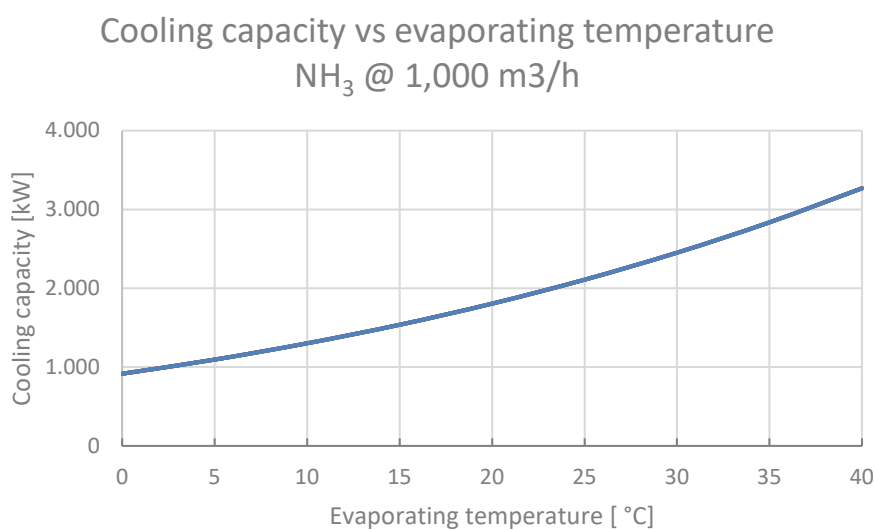

Figure 4 Cooling capacity of a specific compressor dependent on evaporating temperature.

Therefore, the heat capacity of heat pumps utilizing ambient heat sources is usually greatest during summer. Figure 4 shows the performance of a specific compressor at certain DH temperatures and serves only as an example. The relation can differ dependent on the specific design. For assessments, it is thus important to notice capacity deviations for the specific plants considered, as well as variations in temperatures.

#### Example of COP calculation

This section demonstrates a method for calculating temperature-dependent COP-values. Table 1 shows the estimated average Lorenz efficiencies for DH heat pumps in Denmark. Generally, larger plants have higher Lorenz efficiencies than smaller plants, and heat pumps utilizing ambient sources typically have higher Lorenz efficiencies than heat pumps utilizing excess heat (though lower actual COP-values). This is primarily because simpler solutions are most profitable in such installations as investment costs are reduced.

**Table 0-1: Estimated Lorenz-efficiencies of heat pumps in market standard installations depending on size and heat source. Estimates are given for the years 2020 and 2050.**

|                                       | Air source |      |       | Excess heat |      |       | Seawater |       |
|---------------------------------------|------------|------|-------|-------------|------|-------|----------|-------|
| Size                                  | 1 MW       | 3 MW | 10 MW | 1 MW        | 3 MW | 10 MW | 20 MW    | 65 MW |
| <b><math>\eta</math>-Lorenz, 2020</b> | 47 %       | 53 % | 60 %  | 40 %        | 45 % | 50 %  | 63 %     | 47 %* |
| <b><math>\eta</math>-Lorenz, 2050</b> | 51%        | 58%  | 62%   | 44%         | 49%  | 54%   | 65%      | 47%*  |

\*The Lorenz efficiency is based on a CO<sub>2</sub> heat pump. The Lorenz efficiency is based on the design temperatures seen in the datasheet.

The estimated efficiencies in Table 1 above, are based on practical experience from installed plants as well as plants currently under construction [15], [18] [21]. These plants, except the plant at DIN Forsyning have many annual operating hours (7,000-8,000) and are expected to operate for 15-25 years. Consequently, energy consumption covers the largest share of the total cost, and high efficiency is a highly prioritized design criterion. Plants with fewer operating hours, on the other hand, might be designed with lower efficiencies.

CO<sub>2</sub> heat pumps have some other thermal properties because the refrigerant will be operating at high temperatures. The COP of a CO<sub>2</sub> heat pump is therefore very dependent on the return temperature from the district heating system. This also means that higher temperatures often can be achieved without significant extra electricity consumption. Lastly, it means that the capacity does not decrease as much with low ambient temperatures in e.g. an air source heat pump.

Larger plants obtain higher efficiencies by using more complex systems. Regarding air source heat pumps, the smaller plants (1 MW) typically consist of glycol-based air coolers and a single condenser, whereas larger plants (10 MW) use direct evaporators, multiple condensing steps and more efficient components. Because of this, it is possible to reach higher efficiencies than those stated for the smaller plants. In practice, however, the investment costs typically outweigh the benefits. For larger plants, optimization is more profitable, and potential optimization beyond the efficiencies stated in Table 1 is limited.

Lorenz efficiencies for air source heat pumps include heat consumption for defrosting. Smaller air source heat pumps typically cool the air 5 K through the cooling surfaces, whereas larger plants of 3 MW and more, cool the air by 4 K as more cooling surfaces and fans are used. Table 2 shows the average temperature of ambient air in Denmark.

**Table 0-2: Average air temperature per month in Denmark (references from 2006-2015) [16].**

|                        | Jan | Feb | Mar | Apr | May  | Jun  | Jul  | Aug  | Sep  | Oct | Nov | Dec |
|------------------------|-----|-----|-----|-----|------|------|------|------|------|-----|-----|-----|
| <b>Mean temp. (°C)</b> | 1.4 | 1.1 | 3.5 | 7.7 | 11.3 | 14.3 | 17.4 | 16.7 | 11.7 | 9.8 | 6.3 | 3.0 |

Using equations 1 and 2 and Table 1 and Table 2, a COP-value for a 3 MW air source heat pump operating in November can be calculated. The heat pump cools the ambient air by 4 K and heats DH water from 35-70 °C:

$$T_{lm,sink} = \frac{T_{out} - T_{in}}{\ln\left(\frac{T_{out}}{T_{in}}\right)} = \frac{70 - 35}{\ln\left(\frac{70 + 273}{35 + 273}\right)} = 325.3 \text{ K}$$

$$T_{lm,source} = \frac{T_{in} - T_{out}}{\ln\left(\frac{T_{in}}{T_{out}}\right)} = \frac{6.3 - 2.3}{\ln\left(\frac{6.3 + 273}{2.3 + 273}\right)} = 277.4 \text{ K}$$

$$COP_{Lorenz} = \frac{T_{lm,sink}}{T_{lm,sink} - T_{lm,source}} = \frac{325.3 \text{ K}}{325.3 \text{ K} - 277.4 \text{ K}} = 6.8$$

$$COP_{real} = COP_{Lorenz} \cdot \eta_{Lorenz} = 6.8 \cdot 53 \% = 3.6$$

### Additional information for compression heat pumps

The most relevant heat sources for heat pumps are at the moment ambient air, industrial excess heat and seawater. Heat pumps utilizing ambient air are being installed in many Danish DH systems at the moment (2020).

Air source heat pumps can be more complex to operate than other types, where the heat source is based on water or glycol. It is important to be particularly thorough regarding the design and dimensioning of the air coolers, where leaves, dust, or frost can block the airflow. Furthermore, wrong placing or inadequate space around the coolers can cause short-circuits of the cooled air. In this case, already cooled air will return to the cooling surface reducing the flow of fresh and “warm” air.

All in all, the design and dimensioning of cooling surfaces have a great impact on the performance of air-source heat pumps, decreasing both heat capacity and COP of the heat pump when designed inadequately.

Defrosting is also important to address properly. Frost should be detected precisely and dynamic defrosting only be provided when needed. Earlier air source heat pumps stopped heat production entirely while defrosting, whereas newer plants continue at reduced or full capacity while defrosting.

Earlier plants were estimated to use 2-2.5 % of the annual heat production to defrost the cooling surfaces [13]. This has been reduced to around 1 % for recently installed smaller plants using secondary circuits, whereas larger plants using refrigerant directly in the air coolers utilize excess heat in the refrigerant to provide defrost without reducing the heat production.

### Absorption heat pumps



In absorption heat pumps, high-temperature heat is used to regenerate a refrigerant that can evaporate at a low-temperature level and hereby utilize low-grade energy. Energy from both drive heat and the low-temperature heat source is delivered at a temperature in between to the sink. In theory, 1 kJ of heat can regenerate around 1 kJ of refrigerant meaning that an absorption heat pump has a theoretical maximum COP of 2. Due to losses in the system, the practically attainable COP is around 1.7. For absorption heat pumps, COP is not affected by temperature levels. Certain temperature differences are required to have the process going, but as long as these are met the COP will be around 1.7 and are not affected by a further temperature increase of the drive energy. The different temperature levels in both drive energy, heat source and DH affect each other meaning that a certain DH temperature is only possible, with an appropriate heat source and/or a certain temperature level of the drive energy. This is important to consider, as these boundaries can the technology in some applications.

The energy flow is illustrated in the Sankey diagram in Figure 5:

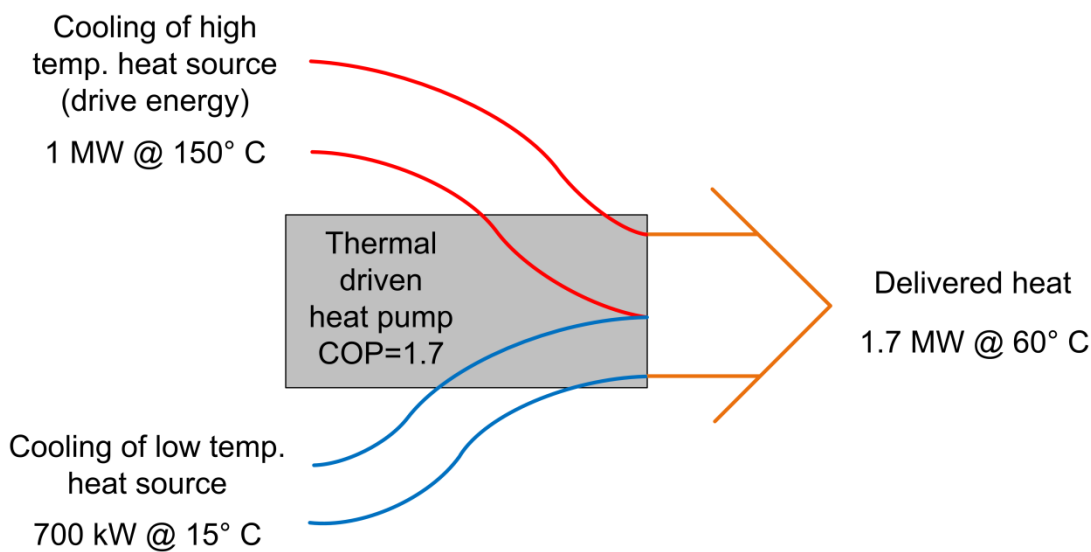

**Figure 5** The high temperature drive energy of 1 MW enables the heat pump to utilize 700 kW from a low temperature heat source at 15 °C. Thus delivering 1.7 MW at 60 °C (COP is 1.7).

Two-stage versions are available for particularly high driving temperatures. In two-stage absorption heat pumps, the drive energy is used twice enabling the heat pump to utilize almost twice as much low-grade energy. The practically attainable COP of two-stage systems is typically 2.3.

For more information about working principles and applications see the Playbook for large-scale heat pumps [1].

### Input

Heat pumps require drive energy and a heat source.

Drive energy for compression heat pumps is mechanical energy, typically provided by electricity in an electric compressor, but engines consuming fuel or biogas can also be used.

Drive energy for absorption heat pumps is heat; e.g. steam, hot water or flue gas. It also consumes a minor amount of electricity.

Heat sources can be ambient air, surface water or groundwater, ground (soil) or surplus heat from industries. Typical Danish temperatures are 0-18 °C as ambient air temperatures and 8-10 °C as groundwater temperature, whereas excess

heat from industrial processes has much higher temperatures – sometimes enabling direct heat recovery. In some cases, the input heat is delivered through a secondary water or glycol circuit, but for optimum performance, the heat source should be connected directly to the evaporator of the heat pump.

A couple of plants utilizing groundwater have been established and surface water from lakes or streams has been investigated for other plants. These energy sources often conflict with other interests such as domestic water supply and/or environmental aspects, which typically results in very time-consuming regulatory approvals.

For larger central plants it is expected that seawater can be utilized in addition to fuel-based combined heat and power production.

This chapter focus on ambient air, industrial excess heat and seawater (for large central plants) as heat sources for compression heat pumps, since these are considered most relevant although other types can be relevant in specific cases.

Due to technical reasons, absorption heat pumps are limited to heat sources warmer than approximately 15 °C. Therefore, it is not possible to utilize ambient sources and the technology is primarily suitable for industrial excess heat and flue gas from combustion.

### Output

Heat is defined as the only output in this chapter, but cooling (which is the input from the heat source) can also be regarded as a useful output. For large-scale heat pumps, the heat will typically be delivered to the end-user through a water-based DH system.

The maximum delivery temperature differs according to type (compression or absorption heat pump) and also within either type depending on the actual refrigerant, design pressure and more. The most commonly used types can reach temperatures of around 72 °C and are the focus of this chapter and datasheets. More expensive high-pressure versions are available where 80 or 90 °C is needed. Special compression heat pumps can reach up to 100-110 °C, but these are only applicable in certain applications.

Absorption heat pumps are limited to around 85-87 °C but the specific delivery temperature depends on the temperature of the heat source.

This is further outlined in the section Research & Development.

### Typical capacities

Ammonia large-scale compression heat pumps are commercially available in capacities of up to around capacities of from 0,5-5 MW, but multiple heat pump units can be connected in groups and thereby provide the required capacity. The largest plants in Denmark with ammonia heat pumps are approx. 40 MW. Depending on temperature requirements a heat pump system often consists of several compressor stages to reach the highest efficiency. Depending on the heat source and supply temperature to district heating, it is expected that heat pumps often will be several heat pump units in parallel, also due to redundancy. Danish compression heat pumps mainly use ammonia as a refrigerant in combination with positive displacement compressors, however, CO<sub>2</sub> and HFO's are becoming more common for large-scale heat pumps. With the introduction of low-GWP HFC's called HFO's [17] the use of turbo, compressors are also possible, which could be beneficial for even larger compressors and plants.

Absorption heat pumps are available in capacities of up to around 12 MW of cooling. The heat output including drive energy will thus be around 20 MW.

### Dynamic response and other power system services

Regulation ability is a topic currently being investigated in several projects.

As today's market is very limited, the large-scale heat pumps on market today are not constructed for very fast start/stop or load changes. Using adequate secondary water systems and control methods around the heat pump can enable most large-scale heat pumps to fast start and stop. In practice, the possibilities of fast regulating depend on the specific heat pump configuration and type as well as system requirements such as outlet temperatures and efficiencies.

### Advantages/disadvantages

Table 3 summarizes the main advantages and disadvantages of the different types of heat pumps and applications.

**Table 0-3: Advantages and disadvantages of heat pumps.**

| Type  | Compression |             |          | Absorption  |
|---|-------------|-------------|----------|-------------|
|   | Ambient air | Excess heat | Seawater | Excess heat |
| <b>Advantages</b>   |             |             |          |             |
| Utilization of low-temperature heat sources   | x           | x           | x        | x           |
| Coupling of electricity- and heat sector  | x           | x           | x        |             |
| Yields higher thermal output than required driving energy (COP > 1)   | x           | x           | x        | x           |
| Can be installed in locations with restrictions on exhaust emissions  | x           | x           | x        | x           |
| Can supply combined heating and cooling   | (x)         | x           | (x)      | x           |
| Low variable production cost  | x           | x           | x        | x           |
| <b>Disadvantages</b>  |             |             |          |             |
| The working principle is still unfamiliar to parts of the heating industry  |             |             | x        |             |
| High COP requires a low-temperature difference between source and sink  | x           | x           | x        | (x)         |
| Changes in flow or temperature of the heat source affect the performance of the heat pump (capacity and COP), which can increase the complexity of the system | x           | x           | x        | x           |
| High specific investment costs (CAPEX)  | x           | x           | x        | x           |
| Is not fully available during the coldest periods   | x           |             | x        |             |

A general advantage of heat pumps is that the heat pump can recycle excess heat or utilize energy from the ambient which enables the utilization of heat sources otherwise left unused by conventional heat production technologies.

In energy systems where electricity plays a vital role, compression heat pumps can incorporate electricity in heating systems in an effective manner. For processes that are electrically heated, heat pumps reduce power consumption and load on the electrical grid, especially if the heat pumps are combined with energy storage.

Compression heat pumps that are electrically driven have no direct emissions from burning fuel, meaning that these systems can be installed in locations with restrictions on exhaust emissions.

Absorption heat pumps utilize the energy quality of high-temperature heat sources where exergy is otherwise wasted when for instance a boiler is used to heat water up to 70 or 80 °C. In such applications, absorption heat pumps can exploit heat from the boiler at a higher temperature to recover heat from a lower temperature, thus reducing fuel consumption by approximately 40 %.

Compared to traditional heating technologies, heat pumps utilize a different working principle that is still unfamiliar to some parts of the heating industry, however many heat pumps are now installed for district heating production, so the technology is becoming a more familiar technology.

To reach high COP, heat pumps require low-temperature differences between source and sink. Therefore, heat pumps are best suited for low-temperature systems.

The heat source must be available and suitable according to the required heat demand. Changes in flow or temperature of the heat source will affect the performance of the heat pump (also heat capacity and O&M), which can increase the complexity of a heat pump system.

Compared to most traditional heat production systems, heat pumps, in general, have higher investment costs and lower energy consumption costs.

For seawater heat pumps, there are added layers of complexity regarding its operation, which include organic material removal from filters, ice protection of water intake, and the fact that seawater is rough on the system and its components [20], [21].

### Environment

The primary environmental impact of heat pumps stems from the drive energy consumption and depends on the fuel type and production method. Absorption heat pumps are typically applied where fuel is already burned, meaning that the absorption heat pumps do not increase fuel consumption, but simply increase the heat output of existing energy consumption.

Greenhouse emissions from refrigerants are negligible as Danish legislation prevents high GWP-refrigerants in circuits with more than 10 kg of refrigerant. Therefore, heat pumps with a heat capacity of more than 60-80 kW use natural refrigerants or low GWP-HFC's.

Because of the Danish regulation, natural refrigerants are widely used in Denmark and they are also increasingly being used in other countries as well. In Denmark, large-scale heat pumps mainly use ammonia as a refrigerant as this ensures high efficiencies and utilizes well-proven industrial components for reliable operation and long service life. Even though ammonia is the most frequently used refrigerant other refrigerants are starting to play a role in large heat pumps in Denmark. Both CO<sub>2</sub> and HFO have been used more and especially in the +50MW heat pumps these refrigerants have potential because larger units are available (more MW/compressor). Furthermore, will the amount of ammonia sometimes result in becoming a risk company (more than 5 tons within 200m [19])

Ammonia can be dangerous to mammals and especially aquatic life forms. Therefore, ammonia systems must comply with certain safety measures regarding construction, location and operation. Other natural refrigerants are highly flammable but not environmentally harmful.

Fans and cooling surfaces for air source heat pumps produce noise, which, according to the local regulations must be considered. . Practical experience in Denmark [14], [15], [18] show that this is suitably addressed by providing plenty of cooling surface to limit fan and airspeed. With this approach, it is possible to install air source heat pumps close to residential areas. In general noise, problems regard the compressors and noise insulation of the building (which is similar to heat pumps utilizing other heat sources than ambient air) rather than the cooling surfaces.

For seawater heat pumps, it is necessary to make a cold-water dissipation analysis [20], [21]. This is to ensure environmental protection because the dissipation of the cold water at the outtake is restricted to affect the temperature

of the surrounding seawater to a limited degree. The cooling of the surrounding seawater can be limited by increasing the flow through the evaporator. Furthermore is this analysis necessary to avoid a short circuit between the input and output water.

### Research & Development

In most countries, the development within refrigeration moves toward natural refrigerants. The European F-gas regulation excludes the most harmful synthetic refrigerants and ensures that others are phased out during the coming years [5], [7], [9], [10], [15].

With the introduction of low-GWP HFC's and CO<sub>2</sub> [17], the use of turbocompressors is also possible, which could be beneficial for larger plants. However, there is currently (2021) a plant under construction in Esbjerg using CO<sub>2</sub> as the refrigerant.

Danish regulation is even stricter by not allowing high GWP refrigerants in refrigeration units or heat pump installations holding more than 10 kg of refrigerant. Water vapor systems are not yet commercially available, but a demonstration project is being initiated in Aarhus, meaning that low-temperature systems will be demonstrated in the coming years. A new compressor type has been developed for cooling applications or as a low stage circuit for heat pumps e.g. an H<sub>2</sub>O system recovers heat from seawater at 0 °C and delivers it at 20 °C, while an ammonia system takes the temperature from 20 °C and delivers at a higher temperature. The technology has several advantages, especially regarding the utilization of low-temperature water sources such as seawater. This technology can reduce some of the challenges of utilizing seawater at temperatures near the freezing point [9], [10].

Other areas of technology development are:

- Energy-efficient defrosting of air source heat pumps [9], [15]
- Higher outlet temperatures (wider range of high-pressure components) [9], [15]
- Optimize the benefits for the overall power system of using heat pumps [11], [15]
- Intelligent integration in energy systems to increase overall system efficiency [11], [15]
- New control systems for higher flexibility and better system integration [11], [15]

### Examples of market standard technology

Depending on size, annual operating hours and temperature requirements, different types of heat pump design or technology can be the best choice.

The best solutions are often multi-stage plants that will both cool and heat in steps to minimize thermal losses. Oil coolers, desuperheaters and subcoolers are utilized to minimize pressure differences and hereby the mechanical work required. High-efficiency motors are applied, preferably cooled by water or refrigerant. The heat from frequency converters is sometimes utilized as well.

As mentioned earlier, ammonia is the most widely used refrigerant for DH. Depending on the specific requirements regarding temperature demand, capacity as well as practical issues other refrigerants might be preferred. Descriptions of heat pumps that are already operating are found in the *Playbook for large-scale heat pumps* [1].

**Ammonia** is a widely used refrigerant for industrial refrigeration meaning that large-scale equipment with high efficiencies can be utilized for the heat pumps. Ammonia is typically used for the largest plants reaching up to around 73 °C using standard components and up to 90 °C utilizing special components for high-pressure levels.

Examples of installed or under construction plants using ammonia as refrigerant:

2021, Fjernvarme Fyn / Ejby Mølle, Denmark – 20 MW – max. temperature of XX °C (With waste water as HS)

2020, Tårnby Forsyning, Denmark – 6.4 MW – max. temperature 75 °C (With DC and waste water as HS)

2020, Fjernvarme Fyn / Tietgenbyen varmecentral, Denmark - 40 MW – max. temperature 75 °C (With data center as HS)

2020, Gudenådalens Energiselskab, Denmark – 3.6 MW – max. temperature 75 °C (Air and district cooling)

2020, Skagen Kraftvarmeværk, Denmark – 12 MW – max. temperature of 72 °C (Air as HS)

2019, HOFOR, Denmark – 5 MW - max. temperature of 90 °C (Seawater pilot)

2019, Støvring Kraftvarmeværk, Denmark – 8 MW - max. temperature of 72 °C (Air as HS)

2017, Kalundborg Forsyning, Denmark – 10 MW – max temperature of 90 °C (Waste water as HS)

2016, Høje Taastrup Forsyning, Denmark – 3.2 MW – max. temperature of 72 °C (District cooling)

2021, Langå Varmeværk, Danmark – 3.4 MW – max temperature of 75 °C (Air as HS)

**CO<sub>2</sub>** heat pumps operate in the so-called trans-critical pressure range, meaning that the refrigerant has a temperature glide on the warm side while the cold side evaporates at a constant temperature. This means that CO<sub>2</sub> is particularly suited in applications where heat is drawn from a low-temperature source by cooling it only a few degrees, while the delivered heat is provided at a temperature glide of maybe 40 °C. The maximum outlet temperature of CO<sub>2</sub> systems is app. 90 °C. To obtain good COP values in CO<sub>2</sub> systems the inlet temperature of the heated media (system return temperature) should not be higher than app. 40 °C.

Examples of installed or under construction plants using CO<sub>2</sub> as refrigerant:

2022, Aalborg Forsyning /IKEA, Denmark - 1MW

2022, AffaldVarme Aarhus, Denmark – 600 kW

2012, Jensens Køkken, Denmark 200 kW – max. temperature of 80 °C

2012, Marstal Fjernvarme, Denmark - 1.5 MW – max. temperature of 75 °C

**Hybrid H<sub>2</sub>O/NH<sub>3</sub>** heat pumps combine the absorption and the vapor compression cycles, hence the name hybrid. Ammonia is used as a refrigerant but absorbed by H<sub>2</sub>O thus at reduced working pressure meaning that standard components can be used for high temperatures. The maximum temperature in systems in operation is around 90 °C but it is possible to reach higher temperatures using the same components.

Examples of installed plants, hybrid using H<sub>2</sub>O/NH<sub>3</sub> as refrigerant:

2012, Arla Dairy, Denmark – 1.2 MW – max. temperature of 85 °C

2007, Nortura Dairy, Norway – 0.65 MW – max. temperature of 85 °C

**Hydrocarbons** are primarily used in medium-sized applications where either propane or isobutane is used as the refrigerant. These refrigerants can be used with standard components from commercial refrigeration meaning that investment costs are kept at a low level. Propane can reach temperatures of 65 °C whereas isobutene can reach temperatures of around 85 °C. These refrigerants are flammable meaning that heat pumps are often delivered in a special cabinet and installed outdoors.

### Examples of installed plants using Hydrocarbons as refrigerants:

2020, Karup Fjernvarme, Denmark – 5 MW – max. temperature of 85 °C

GKN Wheels, Denmark – 1.1 MW – Propane, max. temperature of 65 °C

Birn, Denmark – 1.2 MW – Propane, max. temperature of 65 °C

Skejby Sygehus, Denmark – 0.2 MW – max. temperature of 85 °C

**LiBr/Water** is used in absorption heat pumps whereas ammonia/water is typically used in absorption cooling systems. Water is the refrigerant meaning that the gauge working pressure is negative. The lowest possible temperature on the source side is around 6 °C while the sink temperature can be up to around 85 °C. The different temperatures influence each other meaning that a low source temperature can limit the delivery temperature for the heat sink.

For higher temperature lifts, it is possible to buy absorption plants where two systems are built into one and connected in series to increase the temperature lift.

### Examples of installed LiBr/Water plants:

2018, Amager Bakke, Denmark 32 MW (cooling)

2018, Egedal Fjernvarme, Denmark

2017, Fjernvarme Fyn, Denmark, 9 MW (cooling)

2016, Thisted Varmeforsyning, Denmark, 3.7 MW (cooling)

2016, Hammel Fjernvarme, Denmark, 1.0 MW (cooling)

2016, Lemvig Varmeværk, Denmark, 0.9 MW (cooling)

2015, Horsens Kraftvarme, Denmark, 3.3 MW (cooling)

2015, Sæby Varmeværk, Denmark, 3.3 MW (cooling)

2015, Vestervig Fjernvarme, Denmark, 0.3 MW (cooling)

2015, Ry Varmeværk, Denmark, 0.4 MW (cooling)

### **Prediction of performance and costs**

In Danish, European and to some extent also global contexts, there is an increased focus on energy efficiency (Danish Energy Policy, European Energy Union and Energy Efficiency Directive). Heat pumps can be a tool to increase energy efficiency. Therefore, a significant market pull can be expected regarding heat pumps.

Large scale heat pumps belong between Categories 3: “Commercial technologies with moderate deployment so far and significant development potential” and 4: “Commercial technologies with high deployment so far and limited development potential”.

### Cost reductions

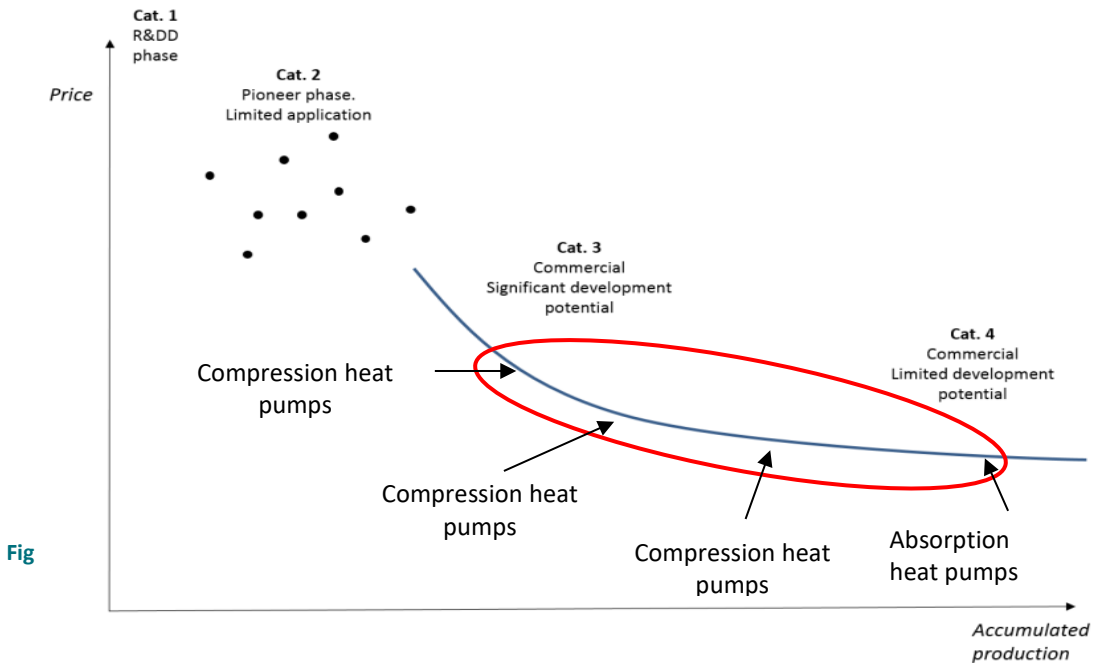

Fig

The technology development of compression heat pumps leaves a potential for cost reduction. Ideally, the prices could match equipment for industrial refrigeration in the future.

Large-scale compression heat pumps derive from industrial refrigeration applying the same principles and many of the same components. However, heat pumps require a higher working pressure meaning that some of the main components are special and limit the supply range. Large-scale heat pumps for high forward temperatures are still rare, meaning that the production numbers for certain components are low.

Absorption heat pumps are applied more widely and therefore, the potential of reduced investment costs is lower than for compression heat pumps. At the moment development primarily concerns size optimization (reduction of footprint), which is more of a barrier than investment cost.

Based on the above the following assumptions regarding accumulated volume and cost reduction for investment and maintenance for heat pumps are introduced.



**Table 0-4: Assumed increase in the accumulated installed units in Denmark.**

| Increase in accumulated installed units | 2020-2025 | 2025-2035 | 2035-2050 |
|---|-----------|-----------|-----------|
| Compression – Seawater                  | 5 units*  | 100 %     | 100 %     |
| Compression – Air source                | 100 %     | 20 %      | 20 %      |
| Compression – Excess heat               | 100 %     | 50 %      | 50 %      |
| Absorption heat pumps                   | 50 %      | 20 %      | 20 %      |

\*As no full-scale seawater heat pumps are installed in Denmark at the moment, these are listed as units.

**Table 0-5: Assumed reduction in cost in the different periods.**

| Reduction in cost         | 2020-2025 | 2025-2035 | 2035-2050 |
|---------------------------|-----------|-----------|-----------|
| Compression – Seawater    | 5 %       | 10%       | 10%       |
| Compression – Air source  | 10 %      | 10%       | 10%       |
| Compression – Excess heat | 3 %       | 3 %       | 3 %       |
| Absorption heat pumps     | 2 %       | 2 %       | 2 %       |

### Energy efficiency and COP

The practically attainable COP depends on both the temperature set and mechanical and thermal losses (Lorenz efficiency) as described in the section Brief technology description.

The Lorenz efficiency is only assumed to increase a few percentage points for the market standard installation [2]. It is however expected that heat pumps with higher COP values will be installed in the future, primarily due to reduced temperatures in DH systems.

### Uncertainty

The future development of investment costs and performance is quite uncertain as these parameters are valued against fuel and electricity costs.

Temperature levels of DH systems, as well as possibilities of co-production with other heating technologies, have a great impact on both investment cost and performance of heat pumps. If the temperature levels of a project do not match the temperatures for the given datasheet, it is advised to adjust the COP according to the outlined method in the subsection describing *COP calculation* in the Brief technology description.

If electricity costs increase it would be profitable to invest in a more expensive heat pump with better performance.

The costs of fuels affect the competitiveness of heat pumps. E.g. expensive biomass, gas, or oil will imply that heat pumps will be better alternatives even with low COP values.

Hence, the competitiveness of heat pumps is not only determined by the improvement of efficient heat pump technology and installation, but also by the development and efficiency of competing technologies, market prices, taxes and subsidies on energy sources including electricity.

One method to navigate this uncertainty is to refer to official scenarios for the development of energy prices issued regularly by the Danish Energy Agency.

In a specific project, context uncertainty can be mitigated by applying the calculation tool developed in combination with the *Playbook for large-scale heat pumps* [1], which enables an initial assessment of the feasibility of a heat pump based on key data for a specific plant.

**Economy of scale effects**

Larger plants tend to invest in more expensive components with higher efficiencies meaning that economy of scale benefits the efficiency of the larger plants rather than the investment costs.

Because of this, the effect of the economy of scale is often limited for large-scale heat pumps. As capacity increases 100 % the investment costs are estimated to increase by 80 %. This primarily concerns the heat pump itself, whereas installations around the heat pump have a greater economy of scale effect.

**Components of investment and O&M**

The investment costs for heat pumps consist of the following overall parts:

- Heat pump
- Heat source (air coolers, connection to industrial excess heat etc.)
- Connection to the power grid (including transformers etc.)
- Connection to existing DH network
- Building for heat pump
- Consulting

The total cost of a heat pump system can vary significantly depending on local conditions and specification requirements. As a rule of thumb, the investment cost of an air source heat pump can be divided as indicated in Figure 7 below. It should be noted, that the specific investment of each part can differ considerably from one project to another.

**Spread of investment costs for air source heat pump**

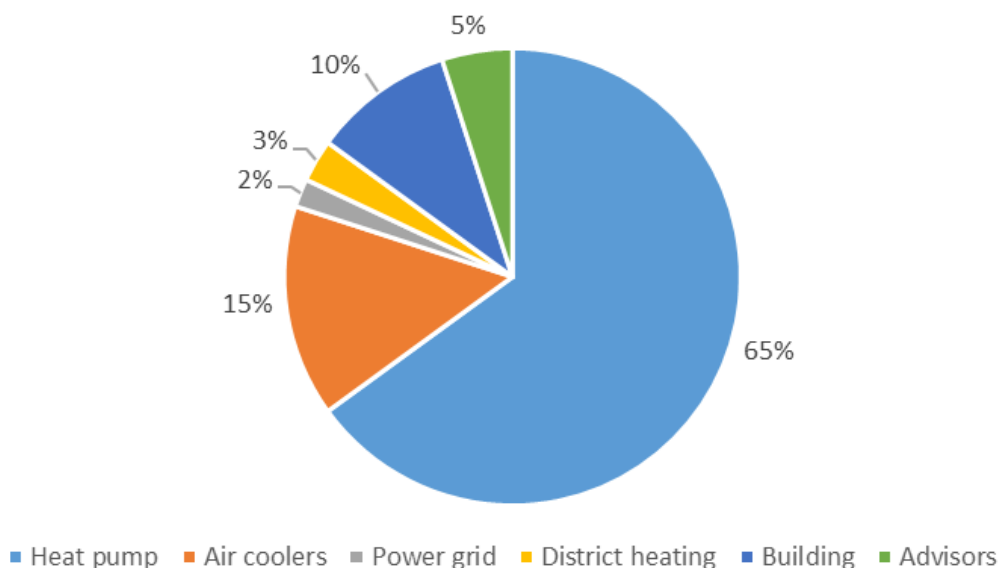

**Figure 7 Typical spread of costs in an air source heat pump. Note that costs for advisors are not included in the datasheets.**

Figure 7 shows that around 80 % of the total project cost relates to the heat pump (including installation) and the heat source (air coolers). This distribution is estimated for smaller plants of 1-2 MW. For larger installations, the relative cost of connection to the power grid and DH system, the building and advisors, will be less, as these do not increase proportionally to the size of the heat pump.

For plants utilizing excess heat, the costs that relate to the heat source can both be less or more depending on the specific conditions.

Regarding operation and maintenance heat pumps require almost no maintenance from the operator [1], [13]. Heat production needs to be planned in context with other production units, but maintenance is always outsourced as it requires certifications to maintain industrial refrigeration. Electrical heat pumps have no chimneys or fuel storage and maintenance is almost always scheduled.

Maintenance includes compulsory inspections and replacements required by law as well as inspections and replacements of oil, refrigerant and worn parts. At 6,000 annual operating hours, the fixed maintenance costs amount to 10-20 % of the total costs, whereas 80-90 % relate to operation.

#### Additional remarks on compression heat pumps

Performance data regarding ambient air and industrial excess heat are based on typical supply temperatures of decentral DH systems with an average return temperature of 35 °C and a forward temperature of around 70 °C. Return temperatures are typically higher in the summertime when space heating is not used. Forward temperatures can rise to 80 °C in peak demand during the coldest periods.

Furthermore, it is assumed that the heat pumps co-produce with peak load units during the coldest periods and therefore only cover 85 % of the annual heat demand. This means that the forward temperature of the heat pump can be kept at around 70 °C during the coldest periods or even lowered depending on the ratio between the different heat production units. A reduced forward temperature during peak demand increases the overall COP of the heat pump.

For 1 MW air source heat pumps it is assumed, that these are designed with a secondary glycol circuit between the refrigerant and air coolers. This simplifies the design and is commonly used on air source heat pumps with less than 1.5 MW of capacity.

For air source heat pumps of 3 and 10 MW capacities, it is assumed, that the refrigerant is used directly in the air coolers ensuring higher efficiency. This design is commonly used in air source heat pumps with capacities above 2 MW.

Defrosting is performed using heated glycol in plants of 1 MW, whereas more energy efficient defrosting is performed on 3 and 10 MW plants using a refrigerant to defrost.

For 1 MW heat pumps utilizing industrial excess heat, simple 1-stage plants are considered whereas more efficient 2-stage plants connected in series are considered regarding 3 and 10 MW plants.

Performance data for seawater heat pumps is based on typical supply temperatures in larger DH systems with a return temperature of 40 °C and a forward temperature of 80 °C.

#### Quantitative description

A key point regarding the application of the data in the data sheets is that the COP may vary considerably depending on the specific temperature set. If the temperature levels of a project do not match the temperatures for the given datasheet, it is advised to adjust the COP according to the outlined method in the subsection describing *COP calculation* in the Brief technology description.

The application of the data in the datasheets for specific calculations of a project should be evaluated according to the specific local conditions. Many factors influence performance and investment costs, and the data sheets should only be

considered as estimates for average installations. There is significant uncertainty regarding large seawater heat pumps, as there are currently no reference plants in Denmark.

### Datashets

The following types and sizes are covered in these technology sheets:

- 1 MW Compression heat pumps using ambient air as a heat source
- 3 MW Compression heat pumps using ambient air as a heat source
- 10 MW Compression heat pumps using ambient air as a heat source
- 1 MW Compression heat pumps using industrial excess heat as a heat source\*
- 3 MW Compression heat pumps using industrial excess heat as a heat source\*
- 10 MW Compression heat pumps using industrial excess heat as a heat source\*
- 20 MW Compression heat pumps using seawater as a heat source
- 65MW Compression heat pumps using seawater as a heat source
- Large single effect absorption heat pumps

\*Data for excess heat is based on cooling water that is cooled from 25 to 15 °C.

The data in all sheets are based on plants that have at least 6,000 annual operating hours and operate for 15 years or more. This means that energy consumption makes up for most of the costs considering the life cycle costs. Because of this, plants with fewer operating hours/years might be designed with lower efficiencies.

### References

- 1 Drejebog til store varmepumpeprojekter i fjernvarmesystemet, Støchkel, Paaske, Clausen, 2017, see [https://ens.dk/sites/ens.dk/files/Varme/drejebog\\_for\\_store\\_varmepumper.pdf](https://ens.dk/sites/ens.dk/files/Varme/drejebog_for_store_varmepumper.pdf)
- 2 Udredning vedrørende varmelagrings teknologier og store varmepumper til brug i fjernvarmesystemer, Sørensen, Paaske, Jacobsen, Hofmeister, 2013
- 3 Absorption chillers and heat pumps, Keith E. Herold, Reinhard Radermacher and Sanford A. Klein, 1996
- 4 Scandinavian Energy Group, 2015, Conversation
- 5 Advansor, 2015, Conversation
- 6 Hybrid Energi, 2015, Conversation
- 7 Innoterm, 2015, Conversation
- 8 Cronborg, 2015, Conversation
- 9 Johnson Controls, 2019, Conversation
- 10 Teknologisk Institut, 2015, 2019, Conversation
- 11 Energinet.dk, 2015, Conversation
- 12 IEA 2012, Energy Technology Perspectives, 2012
- 13 Store varmepumper i fjernvarmen - driftserfaringer, Flørning, Carøe, Nielsen, Støchkel, 2019
- 14 IES/Victor DST, 2019, Conversation
- 15 PlanEnergi, 2019, practical experience from installed plants
- 16 DMI, 2019
- 17 Danfoss, 2019, Conversation
- 18 Varmeværket Bjerringbro, Vejen Varmeværk, Skjern Papirfabrik, Høje Taastrup Fjernvarme, Rødkærsbro Kraftvarmeværk, Kalundborg Forsyning, Rye Kraftvarmeværk, Broager

Fjernvarmeselskab, Sig Varmeværk, Fensmark Fjernvarme, Slagslunde Fjernvarme, Farum Fjernvarme, FFV Energi & Miljø, Karup Varmeværk, Støvring Kraftvarmeværk, Skagen Varmeværk, Strandby Varmeværk, Fjernvarme Fyn, Tårnby Forsyning, Aalborg Forsyning, AffaldVarme Aarhu

- 19 <https://risikohaandbogen.mst.dk/virksomheder/er-virksomheden-omfattet-af-risikobekendtgoerelsen/saerregel-for-ammoniak-og-chlor/>
- 20 Aalborg Forsyning, 2021, Interview
- 21 DIN Forsyning, 2021, Interview

Annex:

## Seawater Heat Pumps

This section describes a large seawater heat pump and is based on interviews with the two utilities DIN Forsyning and Aalborg Forsyning, who currently are establishing large-scale seawater heat pumps [20], [21].

### Location

Large-scale seawater heat pumps can profitably be placed at existing CHP plants. Here the heat pump can take advantage of the existing infrastructure of the CHP plant, such as the direct connection to the DH and power grid. Sometimes, it is also possible to utilize the existing cooling water in- and outtake of the CHP. Hence, the capital expenditures can be significantly lowered if the heat pump can be integrated into the infrastructure of the existing CHP. However, a large-scale seawater heat pump can also be profitable without the infrastructure of the CHP.

The location of the seawater heat pump also depends on the local seawater conditions. This includes the salinity, temperature, and depths. The local seawater temperatures and salinity influence the COP of the system and the yearly annual number of operating hours. The heat pump should be placed with access to deep water since the water properties here are less fluctuating. The average temperature and salinity are slightly higher in the deep water, and therefore, the seawater intake of the heat pump can preferably be placed in deep water. In Esbjerg, the intake is placed in the harbor (at 6.5 m) since the area outside the harbor is too shallow. The intake in Esbjerg harbor is placed at 6.5 m even though the seabed is at 9.5 m. This is a balance of maximizing the depth while avoiding the organic material living at the seabed. The outtake is placed at the surface to minimize the impact on the environment. The in and outtake are placed 1.6 km apart to prevent a short circuit.

Based on measurements in Esbjerg harbor, the average freezing temperature is found to be approx. -1.659 °C with a variation of 0.5 °C. This significant variation is based on the salinity of the seawater which is varying due to the addition of freshwater from streams and heavy rain. A similar tendency applies all over Denmark and especially in the eastern part, where the salinity is varying because of the massive amount of freshwater coming from the Baltic Sea.

Seawater temperatures are more constant compared to air temperatures; fluctuations are monthly more than hourly. Seawater temperatures vary depending on location, but in Denmark the variations are limited. Monthly temperatures are seen in Table 0-6 [1].

**Table 0-6. Seawater temperatures in Denmark, [1]**

| Month  | Jan | Feb | Mar | Apr | May | Jun | Jul | Aug | Sep | Oct | Nov | Dec |
|--|-----|-----|-----|-----|-----|-----|-----|-----|-----|-----|-----|-----|
| Average temperature – Bay and shore (Degree celsius) | 4   | 2   | 5   | 7   | 12  | 14  | 17  | 18  | 15  | 11  | 7   | 4   |

### Seawater Connection

To place the in and outtake properly and to prevent a short circuit in between, it is essential to analyze the cold-water dissipation. This analysis is also important to ensure that any issued permits are complied with. Even if existing in- and outtake of a CHP plant are reused, it is still necessary to perform the cold-water dissipation analysis because flow and temperature are different from the CHP plant.

If the reuse of an existing seawater connection is a possibility, the capital expenditures can be reduced. However, some expenditures are still required to extend the lifetime of the seawater connection. Implementation of a new seawater connection can be an expensive and complex matter as more knowledge is needed on the technology. For instance, DIN Forsyning found it necessary to invest extra resources to obtain a reliable seawater connection and thus maximize the operating hours. This included experimental tests regarding the seabed, pipe materials, and evaporator heat

exchangers. The tests are all related to minimizing the organic material in the intake and the formation of organic material in the system which can be a challenge.

### **Control of Organic Material in the Seawater Connection**

The organic material mainly consists of mussels and barnacles. Filters are installed in the intake of the seawater connection to avoid or at least minimize the organic material in the system. If the organic waste is removed above the surface, it must be transported to a waste station by the regulatory requirements of the Danish authorities. Therefore, the organic waste from the filters can with advantage be removed and handled below the surface. According to DIN Forsyning, tons of mussels and barnacles need to be removed from the harbor every year. In addition, as a precaution, it is possible to supply steam to the filters to avoid frost in the filters.

To avoid the formation and growth of organic material in the pipes, DIN Forsyning has experimental tested and compared the two pipe materials of, respectively, plastic and fiberglass. It was concluded that fiberglass is the smoothest material and, therefore, less exposed to the formation of organic material. However, fiberglass is also the most expensive material of the two at least in smaller dimensions. Hence, the optimum pipe material is a balance between capital expenditures and the necessity of minimizing organic formation. The experimental tests also show a critical velocity in the pipe of approximately 1.5 m/s about the formation of organic material. This means that the formation of organic material can be suppressed by sustaining a seawater velocity of 1.5 m/s or above in the pipe. However, the 1.6 km pipe from the in- to outtake must still be cleaned occasionally.

In general, seawater is rough for the system and also rougher than freshwater. Therefore, as a precaution, freshwater can be injected into the system in certain situations to protect the system to rinse meters and valves.

### **Evaporator Heat Exchanger**

Concerning the heat exchanger installed as an evaporator, DIN Forsyning wants a shell-and-tube heat exchanger in titanium. This is a recognized heat exchanger which is used for seawater heat exchange at several locations. It is a very robust heat exchanger that can be cleaned by letting foam balls through the pipes. This is important as the issued permit restricts the cleaning process to be based on mechanical cleaning.

The falling-film heat exchanger has also been considered because of recommendations from a supplier. The falling-film heat exchanger contains a smaller amount of refrigerant which can be an advantage depending on the issued permits. The supplier claims that this exchanger can handle seawater. However, DIN Forsyning chose to build an experimental set-up and perform tests. It turned out that this type of exchanger has complications related to corrosion. Compared to the shell-and-tube heat exchanger, the falling-film heat exchanger is, furthermore, less stable and efficient. Hence, the shell-and-tube heat exchanger is here confirmed to be the better option for seawater heat exchanging.

### **Ice Defending**

At DIN Forsyning a 60 MW wood chip plant is installed next to the seawater heat pump. The heat from the flue gas condensation can be added to the feedwater of the heat pump to prevent ice from building up. Here, the seawater before the evaporator is preheated by up to 6-7 MW. As a result, the heat pump can operate regardless of the seawater temperature. Ice winters may be an exception. This setting is primarily implemented for safety reasons. Alternatively, the heat should have been exchanged directly between the flue gas condensation and the DH.

### **Environmental Permits**

If establishing a large-scale seawater heat pump, an Environmental Impact Assessment (EIA) is a requirement. The EIA is based on a cold-water dissipation analysis where certain criteria must be fulfilled. This includes that the dissipation of the cold water at the outtake is restricted to affect the temperature of the surrounding seawater to a limited degree.

The cooling of the surrounding seawater can be limited by increasing the flow through the evaporator. Hence, the temperature drop between the in- and outtake is decreased yielding a higher temperature at the outtake. The impact on the temperature of the surrounding water can, furthermore, be limited by integrating a diffuser system at the outtake to improve the distribution of the cold-water dissipation.

However, if a large-scale seawater heat pump is reusing the existing seawater connection of a CHP plant, the existing EIA can also be reused. This requires, however, that the environmental impact of the seawater heat pump is lower than the environmental impact of the former CHP plant. For instance, the EIA is assessed as non-significant for DIN Forsyning, as the environmental impact of the heat pump is significantly lower than the impact from the CHP plant which it replaces. Therefore, the authority process went smoothly and without any major complications for DIN Forsyning. Aalborg Forsyning is also reusing an existing seawater connection, but here the EIA is assessed as significant. This is based on, that the environmental impact from the seawater heat pump might surpass the environmental impact from the existing CHP plant.

Both DIN Forsyning and Aalborg Forsyning are categorized as hazardous industrial sites by the Danish Environmental Protection Agency. Consequently, restrictions are formed concerning the assortment of refrigerants and the management of the refrigerants. This includes that all CFC refrigerants are banned, ammonia and HFO refrigerants have certain restrictions, and natural refrigerants such as CO<sub>2</sub> have no restrictions. These restrictions are related to the quantity of refrigerant and certain requirements for technical equipment in case of leakage of the refrigerant. Often, the companies are applying simultaneously for permits for multiple refrigerants, both HFO's and naturals. From a business perspective this ensures, that multiple suppliers are capable to handle the task and, therefore, multiple tenders will be available.

To avoid any pollution in the seawater environment, the cleaning process of the seawater connection including the evaporator is restricted to exclusive be performed mechanically.

In general, a lot of advice from biologists is necessary to obtain the required permits related to a large-scale heat pump system.

### Status on the Technology

Only a few references are existing concerning large-scale seawater heat pumps and the two systems at Esbjerg and Aalborg are, moreover, the largest worldwide. Therefore, the two systems are unique and can potentially form the foundation for global scaling. Subsequently, there is a wide interest in the two projects from all over the world.

Accordingly, to DIN Forsyning it has been a challenge to find suppliers with experience or comparable references within the subject. This indicates that the technology is in an early phase and has the potential for maturing. The recommendation from the suppliers also differed concerning the refrigerant, compressor type, evaporator heat exchanger, and the number of heat pumps in connection. Again, indicating that the technology is in an early phase of development.

Concerning the compressor, DIN Forsyning has both tenders with turbo compressors and screw compressors. DIN Forsyning assessed that turbo compressors are modern, stable, and well-suited for the purpose, while the screw compressors are less suited for the purpose. In general, the market lacks compressors designed for this capacity, indicating that the technology has potential for development.



Because the technology is in an early phase, Din Forsyning has experienced that it was a challenge to identify the authority and where to request the relevant permits. It was a time-consuming process since many authorities were involved and none of them had experience with the specific topic. In the end, it was confirmed that the authority was the Danish Environmental Protection Agency. From here the authority process went smooth and without complications.

### Operational Hours, Regulation, and Integration of Supplementary Plants

Both DIN Forsyning and Aalborg Forsyning will cover the base load from other energy sources such as excess heat from industry. Also, both plans cover the base/middle load with large-scale seawater heat pumps. DIN Forsyning wants to cover the peak load with a 60 MW wood chip plant and Aalborg Forsyning wants to cover the peak load with a large electric boiler.

Both DIN Forsyning and Aalborg Forsyning plans deliver a forward temperature of 90 °C for DH. However, some suppliers cannot guarantee this temperature and, therefore, it can be necessary to boost the temperature by implementing a supplementary energy source such as an electric boiler. To ensure as many tenders as possible Aalborg Forsyning is open to a system with or without a supplementary boost of the temperature. DIN Forsyning has already agreed with their supplier, who guarantees a forward temperature of 90 °C.

### Refrigerants in Seawater Heat Pump with Focus on CO<sub>2</sub>

At the moment, Aalborg Forsyning is looking into multiple refrigerants to obtain as many tenders as possible. DIN Forsyning has been looking into the three refrigerants CO<sub>2</sub>, R1234, and ammonia, and has found CO<sub>2</sub> to be the most suitable refrigerant for the system.

Among the tenders received by DIN Forsyning, the tender from the chosen supplier using CO<sub>2</sub> as a refrigerant was the only one capable of delivering a forward temperature of 90 °C. This is an advantage since, otherwise, a supplementary energy source is required to boost the temperature. It is not necessarily better for the overall efficiency, however, DIN Forsyning prefers to keep the system as simple as possible.

CO<sub>2</sub> is a natural refrigerant which is an advantage in heat pump systems since it is not subject to environmental restrictions. Non-natural refrigerants such as ammonia are restricted in the allowed quantity. For instance, DIN Forsyning and Aalborg Forsyning are, respectively, restricted to a maximum of 5 tons and 50 tons ammonia. This might cause challenges related to achieving the desired capacities and efficiencies. However, this is not an issue for natural refrigerants such as CO<sub>2</sub>.

The environmental restrictions are also related to safety precautions in case of leakage. This can be a challenge, especially for a seawater heat pump due to detecting restrictions. For instance, for ammonia, it is restricted that the system can detect and process any leakage, which can be an expensive affair. Ammonia is difficult to detect in saltwater and, therefore, a complex detection system is needed. Any contaminated seawater must be encapsulated in the system which can be achieved with fast closing valves. The encapsulated contaminated seawater must be decontaminated or removed. These leakage precautions have high capital expenditures and can, furthermore, shut down the operation for 2-3 days according to DIN Forsyning. However, CO<sub>2</sub> has no restrictions related to detection which is an advantage both in terms of economy and related operational safety.

For a heat pump using CO<sub>2</sub> as a refrigerant, the pressure at the evaporator is huge and has potential hazards in case of leakage in the condenser. If a leak occurs in the condenser, the building could potentially blow up. In general, there is a lack of information on this topic. Therefore, DIN Forsyning has had several talks with the Danish Working Environment Service regarding requirements and dispensations related to the building.

## 41 Electric Boilers

### Contact information:

Energinet.dk: Loui Algren, [loa@energinet.dk](mailto:loa@energinet.dk)

Author: Morten Hofmeister, PlanEnergi, [mh@planenergi.dk](mailto:mh@planenergi.dk)

### Publication date

June 2017

### Amendments after publication date

| Date       | Ref.                | Description  |
|------------|---------------------|--|
| June 17    | 41 Electric boilers | Chapter from previously catalogue revised and added                |
| January 18 | 41 Electric boilers | Updated prices for auxiliary electricity consumption in data sheet |

## Qualitative description

### Brief technology description

Electric boilers are devices in the MW size range using electricity for the production of hot water or steam for industrial or district heating purposes. They are usually installed as peak load units in the same way as an oil or gas boilers. Hence, the following description of electric boilers is based on an operation strategy, aiming at approx. 500 full-load hours/year.

The conversion from electrical energy to thermal energy takes place at almost 100 % efficiency. However, from an exergetical point of view, this technology should be justified by its systemic advantages. Cf. electric water heaters can be a part of the energy system facilitating utilization of wind energy and enabling efficient utilization of various heat energy sources.

Thus, the application of electric boilers in district heating systems is primarily driven by the demand for ancillary services rather than the demand for heat. Although, examples of electric boilers, that operate on the spot market can be found.

Generally, two types of electric boilers are available:

- Heating elements using electrical resistance (same principle as a hot water heater in a normal household). Typically, electrical resistance is used in smaller applications up to 1-2 MW. These electric boilers are connected at low voltage (e.g. 400 or 690 V, depending on the voltage level at the on-site distribution board).
- Heating elements using electrode boilers. Electrode systems are used for larger applications. Electrode boilers (larger than a few MW) are directly connected to the medium to high voltage grid at 10-15 kV (depending on the voltage in the locally available distribution grid).

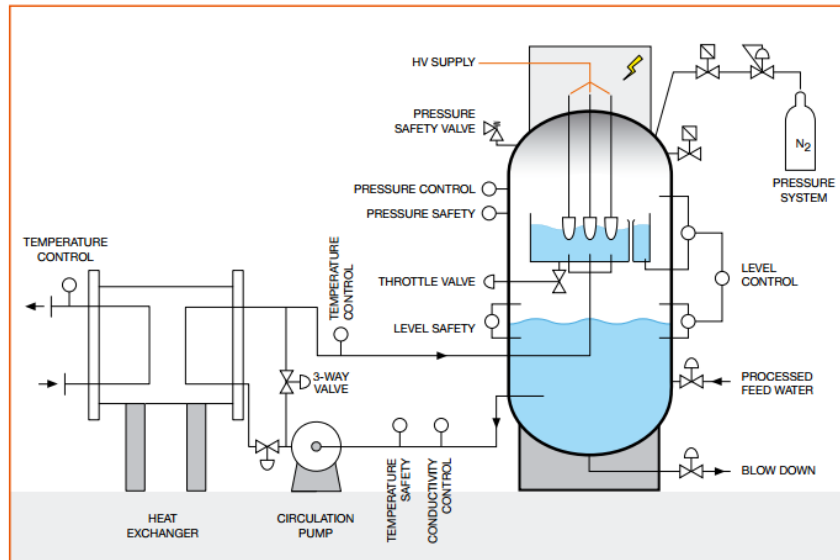

Figure 1: Schematic illustration of an electrode boiler. The heat is generated in the upper chamber through ohmic resistance between the electrodes. The boiler is pressurized with an inert gas system, e.g. nitrogen. [3]

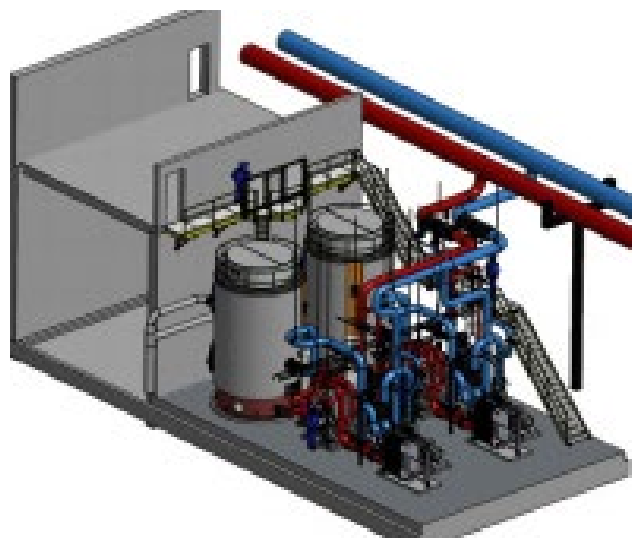

Figure 2: Illustration of 2x40 MW electric boilers installed at Studstrup power plant. The heat exchangers in front of the electric boilers transfer the heat from the water circuit in the boiler to the district heating circuit (blue/red piping). [9]

The water in electrode boilers is heated by means of an electrode system consisting of (typically) three-phase electrodes, a neutral electrode and a water level & flow control system. When power is fed to the electrodes, the current from the phase electrodes flows directly through the water in the upper chamber, which is heated in the process. The heat production can be varied by varying the flow through the upper chamber and the power that is led through, thus enabling output to be controlled between 0 and 100 %. [3]

In a similar technology, the heat output is varied, by varying the contact area between water and electrodes, by covering the electrodes in control screens. Thus the contact area between water and electrodes can be varied by varying the water level around the electrodes.

In both technologies, there will be no high-voltage consumption in a stand-by situation, as the only stand-by consumption is due to circulation pumps, which lies in the range of 5 % of full load.

### Input

Electricity.

### Output

Heat (hot water).

### Typical capacities

Resistance-boilers are available in the span 6-5.000 kW/unit.

Electrode boilers are available in the seamless span 0-60 MW/unit, with typical appliances being 5-50 MW/unit.

Larger applications are typically a combination of multiple single units.

### Space requirements

The net space requirements of electric boilers are in the range of 20-40 m<sup>2</sup>/unit with a total height of approx. 5-6.5 m. Examples of smaller units can be found as well. Furthermore, there is a space requirement of approx. 50-100 m<sup>2</sup>/appliance for heat exchangers, piping etc.

### Regulation ability

Electric boilers can participate in up- and downward regulation. Modern electrode boilers have a minimal standby consumption when used as frequency-controlled reserves (down regulation). The standby consumption varies with the type of electric boiler. New electrode boilers of e.g. 12 MW have electricity consumption down to a few kW and no consumption at high voltage. Older types may have a standby consumption of 5-10 %. The above mentioned new generation of electrode boilers operate in such a way that the voltage is kept in the boiler, without applying any power. Using this technology, the only "stand-by consumption" is related to internal pumps and electric boilers can start with close to no standby consumption. Considering the close to none standby demand, many plants chose to keep the boiler operating in standby mode in order to be able to utilize the electrode boilers immediately when necessary.

Alternatively, it is possible to offer regulating power from cold start, hence eliminating the need for a standby consumption. This is made possible ramp up times of approx. 5 minutes in cold start situations, typically being shorter than necessary to participate on e.g. the power balancing market. However, due to the above-mentioned minimal standby consumption, operation on electrode boilers in standby is very common. The load shift from 0-100 % of nominal capacity is approx. 30 seconds. [8] [9]

### Advantages/disadvantages

#### Advantages

Due to its very simple design, the electric boiler is extremely dependable and easy to maintain. The boiler has no built-in complex components, which may impede operation and maintenance. The boiler has quick startup and fast load-response. It requires no fuel feeding systems and no stack.

#### Disadvantages

As the input energy is electricity, the operating costs are subject to the variation in the electricity prices (market dependent) and the taxes on electricity. Electricity prices thus constitute a major part of the operation costs, without being the only factor to consider when evaluating the economy of operation.

In case electric boilers utilize power from thermal power production, exergetical losses will have to be considered in the evaluation of the total energy balance. Depending on the type of grid connection (full/limited), the availability of the electric boiler may be limited, as explained in the Brief technology description.

### Environment

During operation, the electric boiler uses electricity and the environmental impact from operation depends on the origin of the electricity. Apart from the emissions, due to the consumed electricity, electric boilers have no local environmental impact.

### Research and development perspectives

The technology is well developed, tested and commercially available. Future development will focus on dynamic use of electric boilers in connection with the power system. The development objectives are thus assessed to be limited to the dynamic application of electric boilers, according to the economic & legislative framework, rather than further development of the electric boiler itself. [8] [9]

### Examples of market standard technology

Swedish boiler manufacturer Zander & Ingeström (ZVBA-boiler) [2] and Norwegian boiler manufacturer PARAT (Parat IEH) [3] produce state-of-the-art electrode boilers. Additionally, [7] comprises an overview of installed electric boilers in district heating systems in Denmark, including a map and a list of plants.

### Technical aspects of applying electric boilers in district heating

The technical criteria for participating in the ancillary services of the Nordic electricity market vary in terms of the necessary start up times and the duration of activation. Participating with the early applications of electric boilers (built 2006-08) as manual frequency restoration or replacement reserves (mFRR / RR, start-up time: 15 minutes) could happen from a cold-start. Application as frequency containment reserves (FCR, start-up time: 30s) and automatic frequency restoration reserves for regulating power (aFRR, start-up time: 5 minutes) however required the electric boilers to operate in stand-by. From approximately 2010-12, many electrode boilers were modified, making it possible to ramp up from 0 % to 100 % of the nominal capacity within 30 seconds. Thus, the early boilers today have the same technical specifications in terms of start-up times and energy efficiency as the new built.

Most distribution system operators (DSO) choose to offer limited grid access for electric boilers, thus limiting the available electric capacity for the boilers in hours of high load. Having the possibility of full grid access at all times typically results in higher expenses for the grid connection, worsening the economy of the electric boiler project. Depending on the DSO and the grid situation, a minimum load can be negotiated.

### Operating electric boilers in the Nordic electricity market

The economic framework of the Nordic electricity market is dynamic in terms of necessary capacities and traded volumes as ancillary services. The variation of bidding players results in further dynamics of the market framework, creating a continuously changing framework for electric boilers to be operated within [1] [4].

The first electric boilers in the district heating systems in Denmark were installed in 2006-2008. The design of the electricity market in this period created a promising framework for electric boilers in terms of availability payments in mainly the manual reserve (ramp-up time 15 minutes). This was followed by potentially high revenues from other reserve markets and the trading of regulating power in general. Together with other motives, this resulted in an increase of the installation of additional capacity to approximately 400 MW by the end of 2012 and approximately 490 MW by the end of 2015. Besides the described ancillary services, the transmission system operator (TSO) has the possibility to activate “special regulating energy” (Danish title: Specialregulering) if the stability of the grid makes this necessary. The use of this option has increased throughout 2014-15, mainly due to high penetration and design of subsidy schemes of wind power in Northern Germany. The activation of Danish electricity consumption proved to be a cost-effective way to integrate surplus wind power, with forced shut-downs of wind turbines being the alternative, cf. the curtailment of wind power regulation in Northern Germany in hours of high load [5].

### The techno-economic application of electric boilers in district heating

Based on the above, investments in electric boilers have historically been partially driven by the chance of making a profit at the FCR market. Other arguments for the electric boilers, such as security of supply through the installation of electric boilers as peak and backup capacity are increasing in importance, as the yields from FCR are varying. Furthermore, electrode boilers constitute a promising option for thermal power plants to integrate the electrical output in minimum load operation situations. Thus, the electrical power can be used for heat generation instead of being fed into the grid in hours of negative spot prices.

Since 2012, there has been only one – very large – new application. The installation of 2x40 MW electric boilers at Studstrup CHP plant in Aarhus (2015) and an electrode boiler at Asnæsværket in Kalundborg with a total capacity of 93 MW (2002) are the biggest applications in Denmark yet. Furthermore, a 30 MW electric boiler was installed at a CHP plant of Silkeborg Forsyning.



Figure 3: Overview of large installations in Denmark. The interactive map is available at [7]. A list of applications is available at the same website. 45 applications with a total of 490 MW. The largest applications are 80 and 93 MW (2015 and 2002 respectively).

List of suppliers of electric boilers:

- Aktive Energi Anlæg, [www.aea.dk](http://www.aea.dk)
- Tjæreborg Industri, [www.tji.dk](http://www.tji.dk)
- as:scan industries, [www.scan-industries.com](http://www.scan-industries.com)
- DWC, [www.dwcsystems.com](http://www.dwcsystems.com)

#### Application of domestic scale electric boilers

In the small-scale range, household applications designed for ultra-low temperature district heating systems may serve as supplementing technology. The purpose is to top up the district heating supply to fulfil the hot tap water demand. This enables low temperature district heating implying reductions in heat losses and efficient utilisation of various low temperature heat sources (applying heat pumps with high COP). Small-scale electric water heaters (household application; approx. 5-30 kW) are subject to ecolabelling [6]. These units are described in another catalogue on individual heating technologies.

#### Prediction of performance and costs

Electric boilers are a mature technology. Further development is thus estimated to be limited to reductions in equipment costs, due to an increase in the volume of sales.

The likeliness of district heating companies to invest in electric boilers is dependent on revenues from e.g. the regulating power market and other flexible ways to offer (downward) regulating power as described above. A development potential is the (supposedly increasing) necessity for thermal power plants to operate in minimum load at low or negative electricity prices. As the above factors are subject to uncertainty, minimizing the planning security, no major development of electric boilers is expected. The development potential is assessed to be related to the market shares of electric boilers only, as opposed to further technological development.

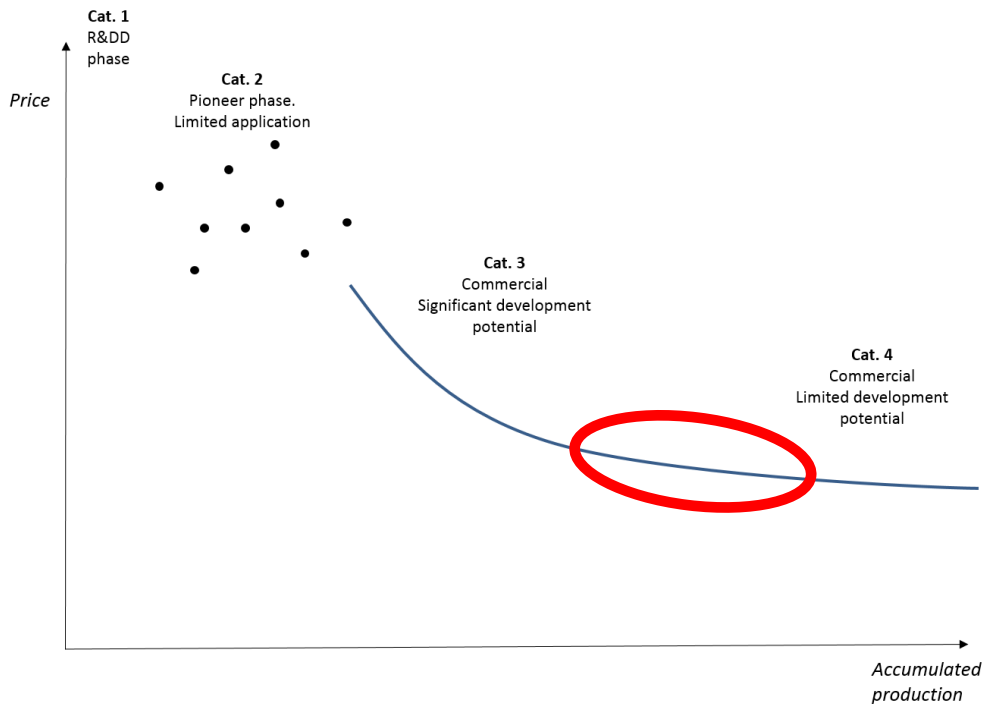

Figure 4: Technological development phases. Correlation between accumulated production volume (MW) and price. Electric boilers are to be placed between category 3 and 4, with the main development potential being related to a possible increased market penetration (“Commercial, limited development potential”).

**Uncertainty**

For electric boilers, the uncertainty is low, because electric boilers are categorized as category 3-4. It is assessed that there will be no major decreases in the equipment costs, as these would imply a strong increase in sales volumes (and vice versa).

**Additional remarks**

The operating costs of an electric boiler are highly dependent on the costs of electricity, i.e. the market price of electricity and currently applicable taxes and fees. Thus, heat production on electric boilers in e.g. a district heating plant can only compete with other heat production units at low electricity prices (e.g. in periods with high wind power production).

The number of full-load hours (heat) for electric boilers is assumed to be 500 according to the Guideline.

## Data sheets

| Technology   | Electric boilers, 400 or 690 V, 0.06-5 MW; 10 or 15 kV, >10 MW |       |       |      |                    |       |                    |       |      |      |
|--|--|-------|-------|------|--------------------|-------|--------------------|-------|------|------|
| Energy/technical data                                  | 2015   | 2020  | 2030  | 2050 | Uncertainty (2020) |       | Uncertainty (2050) |       | Note | Ref. |
|  |  |       |       |      | Lower              | Upper | Lower              | Upper |      |      |
| Heat generation capacity for one unit (MW)             | 5  |       |       |      | 1                  | 25    | 1                  | 25    |      |      |
| Total efficiency, net (%), name plate                  | 98   | 99    | 99    | 99   | 98                 | 99    | 99                 | 99    |      | 9    |
| Total efficiency, net (%), annual average              | 98   | 99    | 99    | 99   | 98                 | 99    | 99                 | 99    |      | 9    |
| Electricity consumption for pumps etc. (% of heat gen) | 0.5  | 0.5   | 0.5   | 0.5  | 0.1                | 0.5   | 0.1                | 0.5   |      | 9    |
| Forced outage (%)                                      | 1  | 1     | 1     | 1    | 0.5                | 1     | 0.5                | 1     | E    | 9    |
| Planned outage (weeks per year)                        | 0.2  | 0.2   | 0.2   | 0.2  | 0.2                | 0.2   | 0.2                | 0.2   | E    | 9    |
| Technical lifetime (years)                             | 20   | 20    | 20    | 20   | 20                 | 20    | 20                 | 20    |      | 9    |
| Construction time (years)                              | 0.5  | 0.5   | 0.5   | 0.5  | 0.5                | 1     | 0.5                | 1     |      | 9    |
| <b>Regulation ability</b>                              |  |       |       |      |                    |       |                    |       |      |      |
| Primary regulation (% per 30 seconds)                  | 100  | 100   | 100   | 100  | 100                | 100   | 100                | 100   |      | 9    |
| Secondary regulation (% per minute)                    | 100  | 100   | 100   | 100  | 100                | 100   | 100                | 100   |      | 9    |
| Minimum load (% of full load)                          | 5  |       |       |      |                    |       |                    |       |      | 9    |
| Warm start-up time (hours)                             | 0.008  |       |       |      |                    |       |                    |       |      | 11   |
| Cold start-up time (hours)                             | 0.08   |       |       |      |                    |       |                    |       |      | 11   |
| <b>Financial data</b>                                  |  |       |       |      |                    |       |                    |       |      |      |
| Nominal investment (M€ per MW), 400/690 V; 1-5 MW      | 0.15   | 0.15  | 0.14  | 0.13 | 0.10               | 0.25  | 0.10               | 0.25  | A    | 9    |
| - of which equipment                                   | 0.12   | 0.12  | 0.11  | 0.10 | 0.08               | 0.20  | 0.08               | 0.20  | B    | 9    |
| - of which installation                                | 0.03   | 0.03  | 0.03  | 0.03 | 0.02               | 0.05  | 0.02               | 0.05  | D    | 9    |
| Nominal investment (M€ per MW); 10/15 kV; >10 MW       | 0.07   | 0.07  | 0.06  | 0.06 | 0.02               | 0.17  | 0.02               | 0.17  | A    | 9    |
| - of which equipment                                   | 0.06   | 0.06  | 0.05  | 0.05 | 0.02               | 0.14  | 0.02               | 0.14  | C    | 9    |
| - of which installation                                | 0.01   | 0.01  | 0.01  | 0.01 | 0                  | 0.03  | 0                  | 0.03  | D    | 9    |
| Fixed O&M (€/MW/year)                                  | 1,100  | 1,070 | 1,020 | 920  | 1,000              | 1,100 | 900                | 1,000 | A    | 9    |
| Variable O&M (€/MWh)                                   | 0.8  | 0.9   | 1.0   | 1.0  | 0.5                | 0.9   | 0.5                | 1.0   |      | 9    |
| - of which is electricity costs (€/MWh)                | 0.3  | 0.3   | 0.5   | 0.6  | 0.1                | 0.3   | 0.1                | 0.6   | F    |      |
| - of which is other O&M costs (€/MWh)                  | 0.5  | 0.5   | 0.5   | 0.4  | 0.4                | 0.5   | 0.3                | 0.5   | A    | 9    |
| <b>Technology specific data</b>                        |  |       |       |      |                    |       |                    |       |      |      |
| Startup costs (€/MW/startup)                           | 0  | 0     | 0     | 0    | 0                  | 0     | 0                  | 0     |      | 9    |



### Notes:

- A The investment and O&M costs are assessed in relation to an approx. operation in 500 hours/year.
- B The installation at low voltage necessitates a transformer substation & expansion of the distribution board. Costs for these are included in the stated equipment costs.
- C Electrode boilers at medium-high voltage are directly connected to the distribution grid. Costs for the distribution board are included in the equipment costs.
- D The installation costs include costs for electrical integration & grid connection fees.
- E The forced outage of electric boilers is very limited and typically well below 1 %. The planned outage is typically limited to 1 day/year.
- F The cost of auxiliary electricity consumption is calculated using the following electricity prices in €/MWh: 2015: 63, 2020: 69, 2030: 101, 2050: 117. These prices include production costs and transport tariffs, but not any taxes or subsidies for renewable energy.

### References

- [1] PlanEnergi, Teknologisk Institut, GEO & Grøn Energi, Review of thermal storage technologies and heat pumps in district heating systems [Danish title: "Udredning vedrørende varmelagringsteknologier og store varmepumper til brug i fjernvarmesystemet"], 2013
- [2] Zander&Ingström, homepage of electrode boiler manufacturer, [www.zeta.se/boilers/en](http://www.zeta.se/boilers/en)
- [3] PARAT, homepage of electrode boiler manufacturer, <http://parat.no/en/products/industry/parat-ieh-high-voltage-electrode-boiler/>
- [4] Parbo, H., Purchase of regulating power, special regulation and other power system services [Danish title: "Indkøb af regulerkraft, specialregulering og øvrige systemydelse"], Presentation at Dansk Fjernvarme, August 31st, 2015
- [5] Article (in Danish): Tyskland beder i stigende grad danske vindmøller om at stå stille. Available at: <http://www.energinet.dk/DA/El/Nyheder/Sider/Tyskland-beder-i-stigende-grad-danske-vindmoeller-om-at-staa-stille.aspx>
- [6] Draft commission decision of [...] establishing the criteria for the award of the EU Ecolabel for water-based heaters, draft version 5, July 2013. Available at: <http://www.ecolabel.dk/~media/Ecolabel/Files/Hoeringer/Blomstm%C3%A6rkedetekstiler-madrasser-maling/Waterbased-heaters.ashx>
- [7] [www.smartvarme.dk](http://www.smartvarme.dk)
- [8] BVA Elektrokessel, Personal Communication, 2016
- [9] Tjæreborg Industri, Personal Communication, 2016
- [10] Tjæreborg Industri, Personal Communication, 2015
- [11] Parat, unknown date, Brochure High Voltage Electrode Boiler, available at <http://parat.no/media/201154/Electrode-Boiler-web.pdf>

### **42 WtE HOP (go to chapter 08)**

A common qualitative description of waste-to-energy and biomass plants (chapters 08 and 09) are found in Introduction to Waste and Biomass plants.

### **43 Biomass Fired HOP (go to chapter 09)**

A common qualitative description of waste-to-energy and biomass plants (chapters 08 and 09) are found in Introduction to Waste and Biomass plants.

## 44 District Heating Boiler, Gas Fired

### Contact information:

Danish Energy Agency: Rikke Næraa, [rin@ens.dk](mailto:rin@ens.dk)

Energinet.dk: Rune Grandal, [rdg@energinet.dk](mailto:rdg@energinet.dk)

### Publication date

August 2016

### Amendments after publication date

| Date         | Ref.                   | Description  |
|--------------|------------------------|--|
| January 2018 | 44 gas fired DH boiler | Updated prices for auxiliary electricity consumption in data sheet |

### Brief technology description

The fuel is burnt in the furnace section. Heat from the flame is transmitted via radiation (and convection) to the inner walls of the boiler and from there to the water to be heated. After the combustion part, the hot flue gasses are led through the convection parts of the boiler and heat is transmitted to the water to be heated.

Shell and flue gas tube type boilers are the most commonly used type of boilers at Danish district heating plants.

The boiler may be fitted with an external heat exchanger (economizer) to utilise any remaining heat (including latent heat) in flue gasses.

Boilers for district heating have been used for decades. Today, many gas fired district heating boilers are used for peak-load or backup capacity. During periods with low electricity prices, gas fired district heating boilers have accounted for a relatively large part of the district heating production as it has been less feasible to operate the engines at CHP plants.

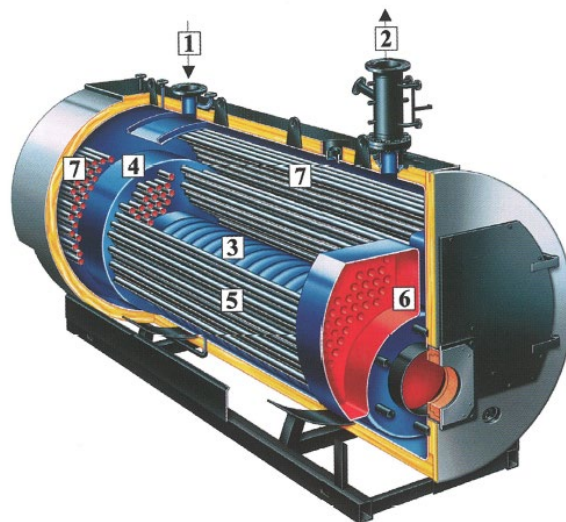

Figure 1 Typical flue gas tube boiler for the power range 1- 20 MW. Combustion takes place in the firetube (3). Flue gasses then passes inside a number of flue gas tubes ((5) & (7)) transmitting further heat to the boiler water around these. The water connections (forward/return) are on the top ((2) & (1)) [6].

### Input

Natural gas or biogas.

### Output

District heat.

### Typical capacities

0.5-20 MJ/s.

### Regulation ability and other power system services

Gas fired boilers has a wide turn-up/turn-down ratio. The load can typically be adjusted within 15-100% load. If in operation, this can be done within a few minutes if needed.

If not heated, start-up of cold boilers often takes some 30 minutes.

### Advantages/disadvantages

#### *Advantages*

Gas fired boilers are a proven and well-known technology. They can be supplied over a wide range of output capacities. Load response is good.

The boilers may also be used for heat extraction at medium- or high-temperature from waste process air.

Heat pumps, either electrical or absorption, may be added to utilize flue gas heat, thereby increasing the efficiency of the heat pump.

#### *Disadvantages*

When gas boilers are being fuelled with diesel or biogas, possibly in combination with natural gas, additional sulphur cleaning may be needed.

### Environment

Sulphur, NOx and methane emissions when burning natural gas are low compared to biomass or waste fired boilers.

If condensing operation is used, the condensate must be treated to comply with local wastewater standards and regulations before being led to sewage systems. Such treatment often includes pH adjustment.

### Research and development perspectives

Multi-fuel operation has been made possible (gas/oil) if supplied with burners for such operation. Biogas is also widely used in same type of boilers. Some boilers can be fitted with special burners for wood dust (e.g. from ground wood pellets) thus enabling conversion to biomass.

### Examples of market standard technology

If operated with low return water temperatures (30-35 °C), a district heating boiler with economizer can achieve a fuel efficiency up to approx. 106-107% (lower heating value (LHV) reference).

### Prediction of performance and costs

Boiler technology, including gas fired boilers, is a commercial technology with large deployment on both national and international scale. Gas boilers are a commercial technology with a moderate need for R&D, making it a category 4 technology.

Development of the burner technology or post treatment of flue gas may lead to lower emission levels.

### Uncertainty

Uncertainty stated in the tables both covers differences between various products and differences related to the power span covered in the actual table.

A span for upper and lower product values is given for the year 2020 situation. No sources are available for the 2050 situation. Hence the values have been estimated by the authors.

No reliable sources are present for the uncertainty of the 2050 numbers listed. However as a deployed, mature and highly fuel-efficient technology, there is relative little uncertainty in performance numbers given.

### Additional remarks

Power production units have been developed to be installed in connection with gas fired boilers. The flue gas from power production units can be used as preheated combustion air for the boiler burner.

Data sheets

| Technology   | 44 District heating boiler, natural gas fired |       |       |       |                    |       |                    |       |      |         |
|--|---|-------|-------|-------|--------------------|-------|--------------------|-------|------|---------|
|  | 2015  | 2020  | 2030  | 2050  | Uncertainty (2020) |       | Uncertainty (2050) |       | Note | Ref     |
| Energy/technical data                                  |   |       |       |       | Lower              | Upper | Lower              | Upper |      |         |
| Heat generation capacity for one unit (MJ/s)           | 0.5 - 10                                      |       |       |       |                    |       |                    |       |      |         |
| Total efficiency, net (%), nominal load                | 105   | 105   | 106   | 106   | 95                 | 107   | 96                 | 108   | A    | 1, 2, 3 |
| Total efficiency, net (%), annual average              | 103   | 103   | 104   | 104   | 93                 | 105   | 94                 | 106   | B    | 1, 3    |
| Electricity consumption for pumps etc. (% of heat gen) | 0.15  | 0.14  | 0.12  | 0.1   | 0.13               | 0.2   | 0.08               | 0.15  | L    | 1       |
| Forced outage (%)                                      | 1   | 1     | 1     | 1     | 0.08               | 2     | 0.08               | 2     |      | 3       |
| Planned outage (weeks per year)                        | 0.4   | 0.4   | 0.4   | 0.4   | 0.3                | 0.6   | 0.3                | 0.6   | F    | 3       |
| Technical lifetime (years)                             | 25  | 25    | 25    | 25    | 25                 | >25   | 25                 | >25   | K    | 3       |
| Construction time (years)                              | 0.5   | 0.5   | 0.5   | 0.5   | 0.2                | 0.7   | 0.2                | 0.7   | F    | 9       |
| Space requirement (1000m <sup>2</sup> per MJ/s)        | 0.005   | 0.005 | 0.005 | 0.005 | 0.003              | 0.01  | 0.003              | 0,01  | E    | 2       |
| <b>Plant Dynamic Capabilities</b>                      |   |       |       |       |                    |       |                    |       |      |         |
| Primary regulation (% per 30 seconds)                  | -   | -     | -     | -     | -                  | -     | -                  | -     | C    |         |
| Secondary regulation (% per minute)                    | -   | -     | -     | -     | -                  | -     | -                  | -     | C    |         |
| Minimum load (% of full load)                          | 15  | 15    | 15    | 15    | 10                 | 20    | 10                 | 20    |      | 9       |
| Warm start-up time (hours)                             | 0.1   | 0.1   | 0.1   | 0.1   | 0.08               | 0.15  | 0,08               | 0.15  | D    | 9       |
| Cold start-up time (hours)                             | 0.4   | 0.4   | 0.4   | 0.4   | 0.3                | 0.5   | 0.3                | 0.5   | D    | 9       |
| <b>Environment</b>                                     |   |       |       |       |                    |       |                    |       |      |         |
| SO <sub>2</sub> (g per GJ fuel)                        | 0.3   | 0.3   | 0.3   | 0.3   | 0                  | 0.3   | 0                  | 0.3   | H    | 1       |
| NO <sub>x</sub> (g per GJ fuel)                        | 10  | 9     | 7     | 6     | 8                  | 60    | 5                  | 30    |      | 1, 2    |
| CH <sub>4</sub> (g per GJ fuel)                        | 3   | 3     | 2     | 2     | 2                  | 6     | 2                  | 6     |      | 1, 2    |
| N <sub>2</sub> O (g per GJ fuel)                       | 1   | 1     | 1     | 1     | NA                 | NA    | NA                 | NA    | I    | 7       |
| <b>Financial data</b>                                  |   |       |       |       |                    |       |                    |       |      |         |
| Nominal investment (M€ per MJ/s)                       | 0.06  | 0.06  | 0.05  | 0.05  | 0.035              | 0.25  | 0.035              | 0.25  | J    | 2, 3    |
| - of which equipment                                   | 0.04  | 0.04  | 0.03  | 0.03  | 0.025              | 0.15  | 0.025              | 0.15  |      | 2, 3    |
| - of which installation                                | 0.02  | 0.02  | 0.02  | 0.02  | 0.01               | 0.1   | 0,01               | 0.1   |      | 2, 3    |
| Fixed O&M (€/MJ/s/year)                                | 2,000   | 1,950 | 1,900 | 1,700 | 1,000              | 2,500 | 1,000              | 2,500 | F    |         |
| Variable O&M (€/MWh)                                   | 1.1   | 1.1   | 1.0   | 1.0   | 0.6                | 2.1   | 0.6                | 2.2   |      |         |
| - of which is electricity costs (€/MWh)                | 0.1   | 0.1   | 0.1   | 0.1   | 0.1                | 0.1   | 0.1                | 0.2   | L    |         |
| - of which is other O&M costs (€/MWh)                  | 1.0   | 1.0   | 0.9   | 0.9   | 0.5                | 2.0   | 0.5                | 2.0   |      | 8, 9    |

### Notes:

- A Includes a condensing economizer, without economizer the efficiency will be up to some 93-97 %, LHV reference
- B Includes a condensing economizer, without economizer the efficiency will be up to some 92-95 %, LHV reference
- C Not Relevant for heat-only technologies
- D Boilers with low water content (e.g. watertube instead of shell tube 3-5 pass boilers) are used start up time from cold is shorter
- E Boilers in the low power range approx. 0.010 and boilers in the higher power range 0.003
- F DGC Estimate
- G Ultra Low NOx burners can reach a level of 5 g/GJ
- H Fuel dependent , not technology dependent
- I No data available
- J The average numbers are for a 2- 3 MW boiler installation
- K Technical lifetime often exceeds 25 years
- L The cost of auxiliary electricity consumption is calculated using the following electricity prices in €/MWh: 2015: 63, 2020: 69, 2030: 101, 2050: 117. These prices include production costs and transport tariffs, but not any taxes or subsidies for renewable energy.

## References

- [1] DGC Statistics, Efficiency and Emission test reports from district heating plants, up to and including 2014
- [2] Burner and boiler manufacturer's information 2015
- [3] Danish District Heating Association, information given to the 2012 survey for the report
- [4] Inputs given by Trade Organisation and boiler installation Company
- [5] Industriell Energigasteknik, Gas Akademin, SGC 2011
- [6] Industriell Energigasteknik, Gas Akademin, SGC 2004/Viessmann
- [7] National Environmental Research Institute, Denmark 2009
- [8] Elsam/Elkraft update, Teknologidata for el- og varmeproduktionsanlæg, 1997
- [9] DGC calculations, estimates

## 45 Geothermal district heating

### Contact information

Danish Energy Agency: William Vergo, Filip Gamborg

Author (stand-alone plants): Malthe Jacobsen, PlanEnergi

Author (updated with large-scale systems): Jes Michaelsen, Rambøll

### Amendments after publication date

| Date         | Ref. | Description   |
|--------------|------|---|
| June 2022    |      | Updated with large-scale geothermal systems   |
| April 2020   |      | Updated qualitative description and datasheets. Datasheets are now divided into 1200 m and 2000 m depth, electric- and absorption heat pumps and two different district heating temperatures. |
| October 2019 |      | Heat pump included in financial data for geothermal plants  |
| May 2019     |      | Variable O&M adjusted to include electricity consumption  |
| April 2019   |      | First published   |

## Qualitative description

### Brief technology description

A Geothermal district heating (DH) plant extracts heat from subsurface water reservoirs. Each plant consists of several wells and installations on the surface. Hot water (called the brine) is pumped from deep subsurface natural occurring reservoirs. The brine has a temperature below 100 °C and the heat is extracted using a heat exchanger and possibly a heat pump. Afterward, the heat-depleted brine is returned to the reservoir. The scope for this chapter is geothermal plants exploiting permeable sandstone reservoirs, as the data regarding e.g. Enhanced geothermal systems (EGS) or Hot Dry Rock (HDR) is still very sparse, cf. the section on Research and development perspectives.

Recent definitions of geothermal energy include all heat from the ground. In the context of the technology chapter at hand, only heat production from deep wells (1.000 – 3000 m) is described. The following Technology Catalogues, found on [www.ens.dk/teknologikatalog](http://www.ens.dk/teknologikatalog), cover other uses of ground source-based heat production and storage, such as ground source heat pumps and aquifer thermal energy storage:

- Technology Data for Individual Heating Installations
- Technology Data for Energy Storage

The geothermal potential of a well can be expressed by two key factors: The temperature of the reservoir and the permeability of the sedimentary layers found in the reservoir. On average the temperature of the reservoir increases by around 25-30 °C per 1 km depth in Danish conditions. The permeability is roughly halved for every 300 m of depth [5]. Further, the thermal energy yield from a well is limited by the thickness and continuity of the reservoir layer.



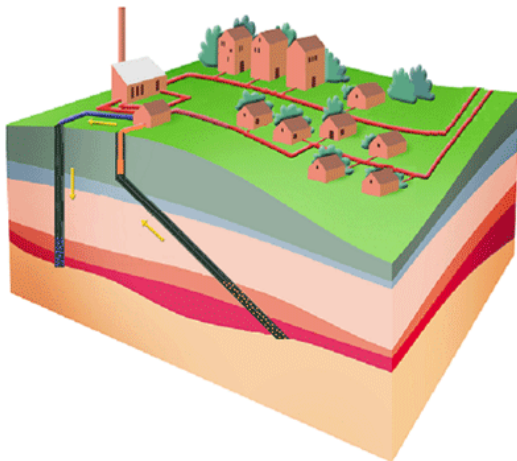

In the typical system, warm geothermal water is pumped to the surface from one or more production wells, where heat is extracted via heat exchangers and possibly a heat pump. The heat-depleted brine is pumped back into the source reservoir via one or more injection wells to maintain the pressure. Figure 0-1 shows a system with two wells, a so-called doublet system. As shown, a certain lateral spacing in the reservoir between production and reinjection wells is necessary. This can be obtained with deviated well trajectories (as the figure shows) or, from a drilling point of view simpler, with vertical wells and a horizontal transmission pipe on the surface.

Figure 0-1: The principle of a doublet system geothermal plant producing into a DH system [7]

The heat from deep reservoirs can be utilized directly through a heat exchanger if the demanded temperature is lower than the temperature of the reservoir. Typically, heat pumps are applied to meet the demand temperature, as geothermal resources in Denmark in most cases are not sufficiently hot to utilize the heat directly. Likewise, the use of heat pumps increases production capacity by cooling the brine before reinjection. The geothermal water has a high content of salt - often 10-20% (weight-%) - and various other minerals.

**Geothermal Potential in Denmark**

The deeper geothermal resources in Denmark are mainly located in two deep, low-enthalpy sedimentary basins, the Norwegian-Danish Basin (marked as *Skagerrak-Kattegat Platformen* in Figure 0-2) and the North German Basin (marked as *Det Nordtyske Bassin* in Figure 0-2). Comprehensive research based on seismic- and well data primarily from previous hydrocarbon exploration campaigns has shown that the Norwegian-Danish Basin contains several geological formations with sandstones of sufficient quality and temperature to serve as geothermal reservoirs [2].

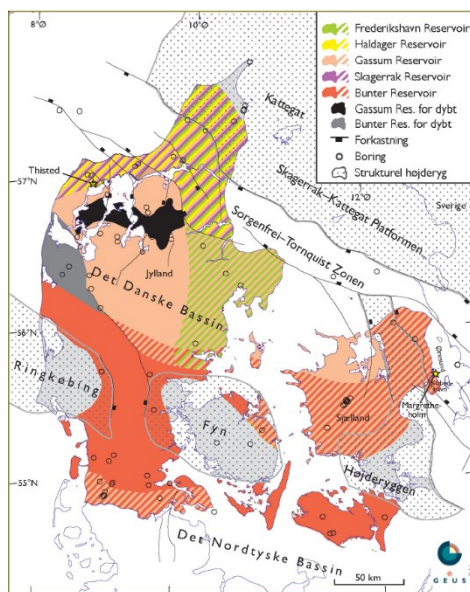

Fairway-map of regional geothermal potentials in Denmark with an indication of the expected reservoirs.

The geothermal potential is situated in the sandstone formations, at depths of 800-3000 m, thickness  $\geq 25$  m.

Grey and black areas indicate that reservoirs do not exist or that they are situated too deep ( $>3,000$  m) or too shallow ( $<800$  m). [6] (Please refer to Annex 2 in [6] and [14] for further information regarding the specific reservoirs)

**Figure 0-2: Fairway-map of regional geothermal potentials in Denmark.**

In a Danish context, the Gassum Formation is assessed to be most relevant in terms of a geothermal potential, which in Thisted, Sønderborg and Stenlille has shown the presence of good-quality sandstones with high permeabilities. Also, the higher Haldager Sand Formation and Frederikshavn Formation are relevant exploration targets in certain areas in Denmark.

The Bunter Formation is the deepest residing Danish reservoir, exploited at Margretheholm, where it was found to have good transmissivity for the production of geothermal brine.

Typically, the permeabilities found in formations suitable for exploration are in the range of 100 to 1000 meters depth where the permeability decreases with depth.

GEUS (The Geological Survey of Denmark and Greenland) has developed a web portal, which provides a general tool for mapping geological formations of interest for geothermal energy in Denmark.

Figure 0-3 shows a map of the depth to the top of the Gassum formation across Denmark generated with this tool.

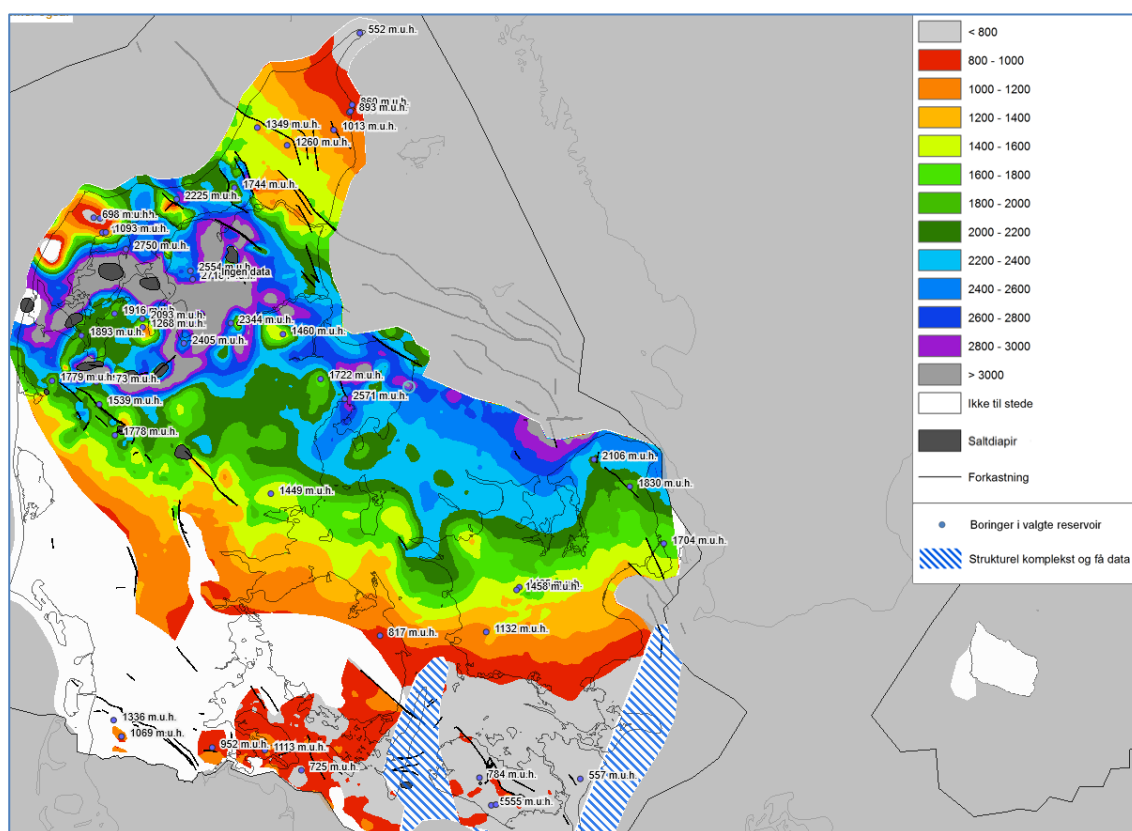

**Figure 0-3: Depth to the top of the Gassum Formation in the Danish area (meters). Locations of wells encountering the Gassum Formation are indicated. Figure from GEUS WebGIS portal <https://dybgeotermi.geus.dk/en/interactive-maps/> selected layers Gassum Fm and "Dybde til top".**

### Energy potential

The technical potential for producing geothermal energy for DH is generally assessed to be high in most parts of Denmark. But the geothermal potential for a specific location will vary according to the availability (thickness and permeability) of reservoir layers at that specific site, which in each case need to be assessed during an exploration phase.

The economic potential depends on the DH systems' locations and abilities to accommodate the produced heat and the heat production price of alternative heat-producing technologies.

Several investigations have been done by DH utilities and other companies regarding the potential of geothermal energy in specific areas. Further, a screening of the geothermal potentials in 28 Danish DH systems was carried out on

behalf of the Danish Energy Agency in 2015 [5]. These 28 DH systems were assessed to be large enough to accommodate heat from a geothermal plant. The study evaluated the projects individually, according to especially two factors: the geothermal potential and the techno-economic system in which a geothermal resource would be applied, taking into consideration the setup of the existing DH system, as well as economic preconditions. Both factors show large variations across the country.

### **Geothermal District Heating**

A key parameter in the design phase of a geothermal DH plant is the set of temperatures (supply/return) in the connected DH grid. Most of the existing Danish DH grids operate at a supply temperature of approx. 70-80 °C at the distribution level. As the temperature of the geothermal well is usually insufficient, it is often boosted using a heat pump. The efficiency of the heat pumps increases with lower temperature differences between the heat source and heat sink, so reducing the DH supply temperature generally increases the feasibility of geothermal DH.

Another important factor regarding the operation phase is the pumping costs. The use of deeper reservoirs with higher temperatures will generally also increase pumping costs, due to lower permeability generally expected for deeper reservoirs. Thus, in a Danish context, it may be economically more attractive to extract heat from shallower reservoirs, typically at 1,000-2,000m depth, where temperatures are 30-70 °C. The heat pumps can either be compressor heat pumps driven by electricity or absorption heat pumps driven by heat, cf. the technology chapter 40 in this catalog.

The return temperature of the DH system is also crucial, possibly enabling direct heat exchange with the geothermal water for a part of the energy thereby increasing the overall system efficiency.

However, there are examples of projects, where the ambition is to achieve the required supply temperature without the use of heat pumps. Thus, direct use of geothermal energy may be possible also in a Danish context, making heat pumps redundant. However, avoiding heat pumps is a trade-off. While it does omit the investments in the heat pumps, the direct use of geothermal energy would also require deeper wells and increased pumping – both of which increase overall costs.

### **Combining Geothermal Wells with Heat Pumps**

Increasing the supply temperature with heat pumps implies a higher reduction of the return temperature of the geothermal water before it is pumped back to the reservoir via the injection well, resulting in increased heat extraction from the geothermal water. However, the possibility of this depends on the chemistry of the water. Hence, applications with heat pumps could increase the efficiency by extracting more heat energy from the geothermal water, but also increase the risk of clogging from minerals in the injection well.

Figure 0-4 presents a simplified illustration of a possible application of geothermal energy for DH. Part of the geothermal heat (46) is used for direct heating of the return water from the DH network, while the remainder (54) is used as a heat source for an absorption heat pump. The COP of the heat pump is approx. 1.7. Thus, the total heat output of the system equals the geothermal input plus the drive energy:  $100 + 76 = 176$  and the COP of the total system is approx. 2.1 ( $176/(76+8)$ ).

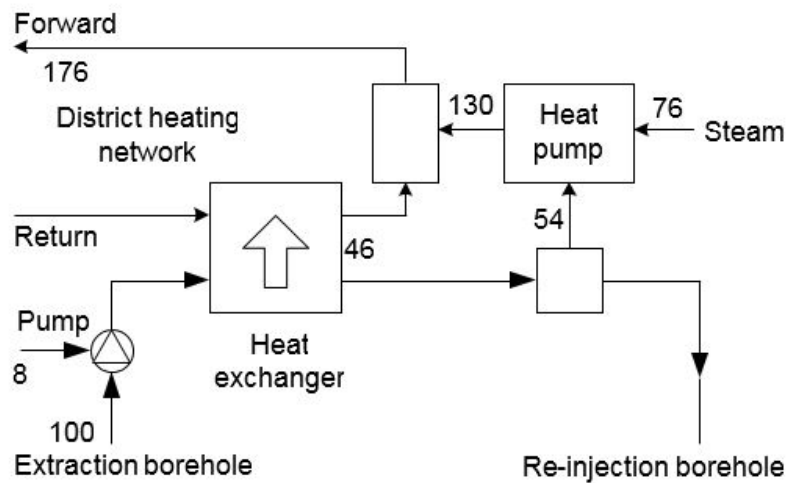

Figure 0-4: Example of a geothermal system with an absorption heat pump. The numbers indicate the energy flows relative to the extracted amount of geothermal heat from the reservoir, which is set at 100 energy units. The heat pump COP is 1.7 and the total efficiency of the system is approximately 2.1.

The thermal energy to drive the absorption heat pump (76 energy units) may be delivered by a DH plant (e.g. biomass boiler or waste incineration plant), which is usually at a temperature of 120-150 °C.

Electricity consumption for the geothermal circulation pumps is normally 2-10 % of the heat extracted from the geothermal water [14], but the exact number depends on a range of factors, e.g. the depth and properties of the reservoir, and the cooling of the geothermal water.

In all cases, the energy used for the electrical submersible pump will to some extent be recovered as heat in the geothermal water. However, as a rough estimate, the heat losses in the well will correspond to the energy used for pumping, and thus 100 energy units are assumed available for DH.

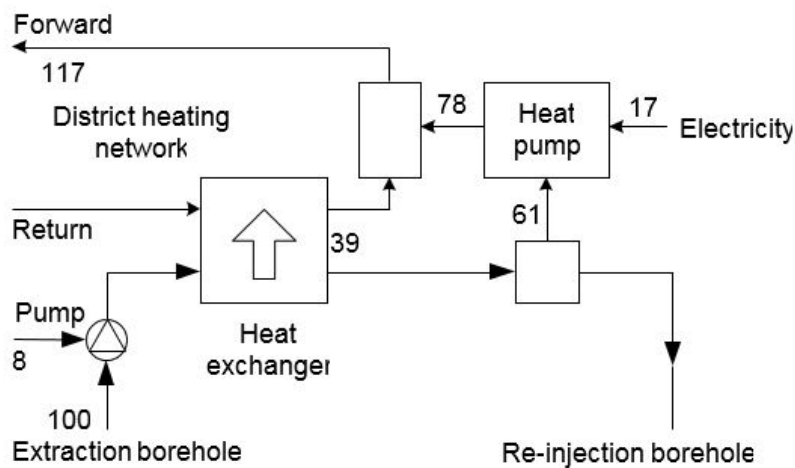

Figure 0-5: Example of a system with an electric heat pump. The COP of the electric heat pump is approximately 4.6 and the total efficiency (COP) of the system is approximately 4.7.

As shown in Figure 0-5, electric heat pumps can extract relatively more geothermal energy than absorption heat pumps as their drive energy constitute a smaller part of the heat output.

Note that the auxiliary energy in the above cases is included in the total efficiency.

### Input

The heat from brine (saline water) from subsurface reservoirs.

Indirectly, to increase the temperature to the appropriate level in DH systems, electricity or thermal energy is needed in heat pumps, cf. the above section regarding technology-combinations of geothermal wells and heat pumps. The thermal energy may be supplied as steam or high-pressure hot water, through the combustion of (bio-)fuels or as excess heat.

Electricity for submersible and reinjection pumps.

### Output

Thermal energy for DH.

Please refer to the section on Research and development perspectives for an example of geothermal electricity production in a Danish context.

### Typical capacities

5-20 MW per facility (1-3 production wells and 2-6 injection wells) without heat storage. However, for large-scale facilities, the ratio between production and injection wells is expected to decrease. Ideally, the ratio could potentially reach 1:1 depending on ground conditions, well design, and ongoing maintenance.

### Examples of best available technology

Several plants using geothermal reservoirs, comparable to those in Denmark, are in operation in neighboring countries, e.g. Sweden, Germany and Poland, see e.g. [14], and [16].

The three Danish geothermal DH plants are:

- **Thisted** has produced thermal energy since 1984 for DH. (Nominally) 7 MJ/s heat is extracted from water (44 °C, cooled to 10-12 °C) by absorption heat pumps, driven by high-pressure hot water that is heated by either a waste incineration plant, natural gas or straw (boilers). The geothermal reservoir is located approx. 1,300m below the surface. The production license was renewed in 2016 for another 30 years. A third well was drilled in 2017-18 as a supplementary injection well [11].
- **Amager**, established in 2005, is a demonstration plant, exploiting the Bunter reservoir at 2.6 km, with a temperature of 73-74 °C, cooling the geothermal water to 17 °C. Geothermal capacity is nominally 14 MJ/s. Three absorption heat pumps are used, driven by steam from the steam system in Copenhagen or the CHP plant located close to the geothermal plant. The facility was established as a demonstration facility and was not intended to deliver continuous input to the DH system. The facility was connected to the peak load system at Amagerværket until 2013 when it was re-connected to the ordinary production system [1]. The facility has suffered numerous production issues, mostly due to clogging of the injection wells and heat pump failure and is currently not in operation (2020)<sup>17</sup>. The plant consists of 1 production well and 1 injection well.
- **Sønderborg** commenced operation in 2013. The plant is designed for the production of 12.5 MJ/s geothermal heat by using absorption heat pumps, driven by two wood chip boilers, that increase the temperature of the geothermal water from 48 °C to the DH supply temperature of 82 °C, and an injection temperature of 15 °C. The geothermal plant is located 4 km from the CHP plant due to the geological conditions [1]. The plant has been operated at reduced capacity and is now (2020) temporarily stopped due to persistent injectivity problems [14].

---

<sup>17</sup> Ingeniøren 17.01.2020.

### Research and development perspectives

The International Energy Agency (IEA) expects the major development in geothermal energy to be in the increased deployment of geothermal power production. However, the increased deployment of geothermal energy for heating purposes is mentioned as an area of development too. Furthermore, the two applications of geothermal energy overlap to some extent, e.g. regarding drilling technology [4].

The following areas of development are assessed to be the main development objectives:

- New technologies:
  - Hot Dry Rock (HDR) (internationally): Heat extraction from hot dry rock layers at e.g. 3,000-4,000 m below the surface. The challenge is to increase the extremely small natural fractures, allowing water to be heated to temperature levels, where it can be used for electrical power production. As there are still expected to be water-bearing geothermal potentials in Denmark that are to be explored, which are significantly easier to exploit, HDR is not expected to gain significance in Denmark in the short- and midterm perspective.
  - Enhanced Geothermal Systems (EGS) (internationally): Making it possible to exploit geothermal heat in impermeable solid rock formations. Still in a very early phase.
- New deep drilling technologies and improvement of existing (horizontal, multiwells), resulting in possible cost reduction for deep wells of approx. 25 % [3]
- Improved design and operation of plants [3]:
  - Well design and completion<sup>18</sup>, the definition of suitable materials, e.g. composite-material well-casing, reservoir stimulation, prevention of formation-damage, high-temperature-high-pressure tools, etc.). Potential to reduce operation and maintenance costs by at least 25 %
  - Improvement of pump technologies, resulting in a reduction of the electricity demand of up to 50 %
- Better utilization of the geothermal resources could furthermore be achieved by lowering the DH temperatures. This would increase the system COP, thus improving the operation economy of the solution.
- Large-scale plant effects are expected to reduce CAPEX primarily as a result of the repeatability factor in particular related to well establishment. The reference case suggests that the costs could potentially be reduced by 15% every time the number of wells is doubled.

Furthermore, strategic international cooperation regarding the mapping of geothermal resources is expected to support the achievement of the above aims. Parts of the above aims are also mentioned in [4] and summarized in Table 1.

In 2016 EUDP-project (1887-0016: Pilot Hole 1b<sup>19</sup>), investigated a possible concept for the successful development of geothermal energy production in Denmark. The project aimed to identify technical and organizational/economic solutions that are relevant in a Danish context. Based on earlier studies regarding the geothermal potential in the Greater Copenhagen Area, the study focused on how to create replicable business models for geothermal energy. One approach that was investigated in the study was the development of several smaller (10 MW<sub>h</sub> each) geothermal plants and obtaining advantages of scale, by building several similar plants. The concept also addresses the risk minimization of geothermal plants, among other factors by [8]:

- 1) using a reservoir with lower temperature but the supposedly lower likeliness of clogging etc. (Gassum-Formation, well-depth of 2100 m instead of Bunter-Formation, 2700 m)
- 2) having several wells per site, to reduce the risk of resource depletion
- 3) Reducing the costs for additional drillings, by reducing drilling depth and thus not being dependent on the success of a few critical wells.

<sup>18</sup> An improved well design is carried out in Thisted in 2017, where a new reinjection well is designed with larger dimension and finer lining, resulting in the pressure drop and thus resulting in less needed pumping effect. [11]

<sup>19</sup> The project was preceded by Geotermisk pilotboring (jno 64015-0027) aka Pilot Hole 1a

In 2020 the research project GEOTHERM<sup>20</sup> addresses geological, technical, and commercial obstacles to significant use of the substantial geothermal resource available in Denmark.

The project has the entire life-cycle of geothermal systems as a perspective. Focus is laid on the reduction of geological as well as technical and commercial risks; sustained productivity is vital. Additionally, the project studies solutions to several challenges associated with geothermal energy.

This project ties together, for the first time, the three main components to the realization of geothermal energy: Science (geology), Technology (production) and Distribution, focusing on the full lifecycle of a geothermal system.

Some of the main results of the GEOTHERM project are:

- Experiences, tools, and methods from the petroleum industry are usable in geothermal exploration.
- Diagenetic and geochemical modeling can contribute to predicting reservoir properties (porosity, permeability, diagenetic alterations) in new areas of geothermal interest.
- With input from among others on-site monitoring of the geothermal brine at the geothermal plants in Sønderborg and Thisted, the causes of injection problems have been investigated including corrosion and scaling processes, showing that careful choice of well-lining and tubing materials besides cautious operation of plants is of utmost importance to prevent problems.
- Reservoir modeling reveals that the cool, re-injected water is re-heated on its way towards the production well(s). Also, once the cooled water reaches the production well(s) the decrease in temperature over time is considerably less than previously assumed. This prolongs the lifetime of the geothermal wells and makes a larger utilization of the geothermal resource possible.
- A geothermal business case has been developed to have a lifetime assessment of geothermal plants including feasibility, design, drilling, construction, production, and abandonment.

### Regulation ability and other system services

The geothermal flow should, as a rule, be operated continuously. However, in combination with electrical heat pumps, up- and down-regulating services can be provided. Up-regulation by turning off heat pumps (reducing the electricity consumption) and down-regulation by increasing the power consumption (and hence output) of the heat pumps. In this case, the operation can be varied from 20 to 100 %. The flexibility can also be obtained by applying heat storage. This is, however, only relevant to a limited extent, since the geothermal production is primarily baseload and, in general, will be operated as such.

### Advantages/disadvantages

Advantages:

- Low costs in the operational phase and low variable costs
- Renewable energy source and environmentally friendly technology with low or no direct CO<sub>2</sub> emission
- High operation stability and long lifetime
- Potential for combination with other production technologies and heat storage
- Limited area requirement
- No noise
- No direct emissions
- Local resource – security of supply
- Stable long-term production costs, once in operation
- Potential in many areas in Denmark

Disadvantages:

- A high geological risk persists until the first exploration well has been drilled and the reservoir has been tested
- High investment costs
- Extensive project period for development and construction
- Needs access to a heat sink with a corresponding baseload or a long-term storage

---

<sup>20</sup> <https://dybgeotermi.geus.dk/geotherm/>



- The best reservoirs are not always located near cities (can partly be addressed through transmission pipes)

### Environment

The utilization of geothermal energy does not result in any local emissions. The largest challenge is the handling of geothermal water on the surface. At startup, the loop is opened to save on filter capacity and for the first few hours, the water is led to a recipient, if possible. Noise during the construction phase is an issue. Drilling is typically ongoing 24 hours a day for 3 months.

Indirectly, in the case of the application of thermally driven heat pumps, there may be environmental considerations, related to the energy source/fuel used to drive the heat pump. Correspondingly, when electric heat pumps are chosen, there may be emissions related to electricity consumption.

### Assumptions and perspectives for further development

Geothermal energy has significant development potential and provided adequate risk mitigation, geothermal DH technology could reach a level of commercialization enabling it to have a significant application in the supply of DH in Denmark.

Therefore, geothermal DH in a Danish context is categorized in a late phase of Category 2 “Pioneer Phase, Limited Application”.

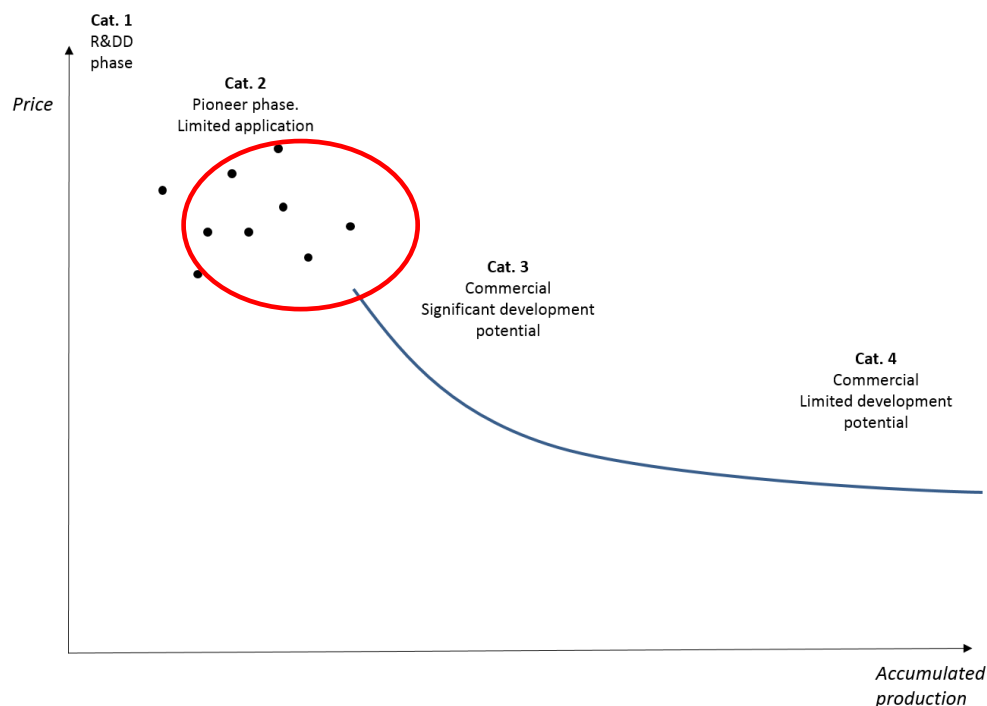

**Figure 0-6: Technological development phases. Correlation between accumulated production volume (MW) and price.**

Geothermal DH is based on proven technology in the oil business (geophysical surveys, drilling, etc.). There are barriers to further deployment – these are mainly non-technical barriers e.g. handling of the risks related to the initial exploration and drilling costs.

There is a potential for technological development, and in the Danish context, the application is limited (only three plants are operating). Several Danish feasibility studies have assessed the commercial improvement potential for up-scaling [18] [19]. Potential savings and advantages of scale can be achieved by upscaling each plant or by building several smaller plants in a successive row. By one source, it is estimated that a 10-15 percent reduction of the investment costs for each marginal plant can be achieved every time the number of plants in a series (the number of wells) is doubled – i.e. from one to two plants, from two to four plants, from four to eight plants and so on [17].



Cost reductions can be achieved when building plants in larger series owing to, among others, the following factors [17]:

- Learning curve for well construction: The average drilling time per well declines as a larger series of wells are sequentially produced since the rig's operational performance is gradually optimized and the geology becomes better known.
- Lower average fixed establishment costs per unit: The drilling rig's mobilization/demobilization costs are divided between a larger number of wells rather than between 4 to 6 wells.
- Economies of scale when ordering: Lower prices for equipment and services can be obtained when a large order is tendered (classic quantum discount).
- Lower average engineering cost per unit, e.g. with scalable modularized facilities.
- Lower operating costs, e.g. Fewer employees are required per MW to operate plants in larger series and spare parts stocks may be reduced with standardized design.

Table 1 gives an overview of future technology milestones for geothermal energy from an international perspective.

**Table 1: Technology milestones for geothermal. (EGS: Enhanced Geothermal System, enhancing or creating geothermal resources in hot dry rock (HDR) through hydraulic stimulation) [4] (2012).**

| 2015   | 2020 | 2030                                | 2040                                   | 2050                         |
|--|------|-------------------------------------|--|------------------------------|
| Improve geothermal resource assessment to accelerate geothermal development by developing publicly available databases, by ensuring an integrated approach for EGS identification and by developing geothermal tools for identifying hot-rock and hydrothermal resources.                  |      |                                     |  |                              |
| Improve accessing and engineering the resource by developing cheaper drilling technologies, by improving hard rock and high-temperature/high-pressure drilling and by improving down-hole instrumentation and well monitoring.   |      |                                     |  |                              |
|  |      | <i>Reduce drilling costs by 10%</i> | <i>Introduce new drilling concepts</i> |                              |
| Develop EGS pilot plants in different geologic environments, develop stimulation techniques and decision tools for reservoir modelling, improve management of health, safety and environmental (HSE) issues, ensure long-term production and scale up EGS to realise 50 to 200+ MW plants. |      |                                     |  |                              |
|  |      | <i>20 MW EGS plants</i>             | <i>50 MW EGS plants</i>                | <i>(towards 200 MW 2050)</i> |
| Explore feasibility of alternative hydrothermal and hot-rock resources.  |      |                                     |  |                              |
| <i>Off-shore geothermal, magma</i>   |      |                                     |  |                              |

**Uncertainty**

Geothermal projects are generally connected with relatively high uncertainty compared to other heat generation technologies. The economy and performance of specific projects may vary significantly with the geological conditions at different locations. Since uncertainties mostly lead to negative impacts on the project economy, they can be interpreted from a risk perspective.

**Exploration and construction risks**

The initial assessment of the geothermal potential before the drilling and testing of an exploration well depends on available seismic and geological surveys, quality of models, performance data for and distance to reference wells, etc. The uncertainties for a given geothermal project are continuously evaluated throughout the project from the initial screening and idea phase to the commissioning in case the project is carried out. The risk linked to geothermal projects is thus highest in the early project phases and can be significantly decreased by carrying out test wells. However, the risk of an initiated project not leading to an operational plant remains high, until the first drillings are evaluated positively.

As a rule of thumb, the project uncertainties can be mitigated by having a continuous risk management process with the participation of relevant stakeholders. The risks should be reviewed at each step/decision (in the illustration

below). The risk/uncertainty process should look at technical, commercial, and regulatory/permitting items, and generally also address the project organization and the responsibilities of each party. The risk will drop significantly after step 5 when the exploration well has been drilled and tested. Upon non-optimal technical parameters, the project group must be able to drop/stop the project as non-economically feasible.

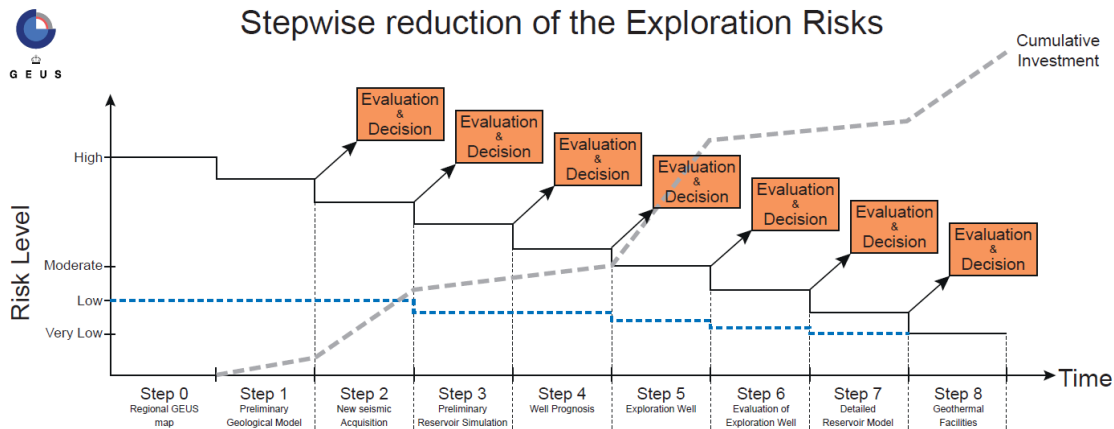

**Figure 0-7: Illustration of the correlation between accumulated investment costs and risk reduction in the fundamental steps of geothermal projects. The black line illustrates the risk level in a green field project, where no or very little knowledge about the geological and seismic preconditions does exist. The blue dotted line illustrates the risk level in a project, where basic knowledge about the seismic and geological preconditions does exist, resulting in lower risk levels in early project stages. The figure is a translated version of Figure 30 in [10].**

Besides the uncertainty regarding the geothermal potential of a specific reservoir at a specific location, especially the drilling process is also uncertain in terms of duration, which implies a relatively high-risk level on CAPEX budgets. Thus, a relatively high contingency is usually included in the budget for drilling projects.

#### Risks in the operational phase

The risk of a geothermal project is not only present in the project development and construction phase. Certain risks remain during the operational phase. Two of the three geothermal plants in Denmark (Sønderborg and Margretheholm) have discontinued the operation owing to long-lasting operational issues, and it is at present unknown whether they will resume operation. The operational issues in one of these plants initially pertained to the precipitation of radioactive material on the inside of the geothermal well casings, leading to reduced injectivity, combined with other technical problems, e.g. the heat pumps. The operational issues related to the other concern incremental injection degradation, probably due to, among other things, incorrect selection of sand (gravel pack) for the screens. These two types of operational issues are well known by geothermal companies in other countries.

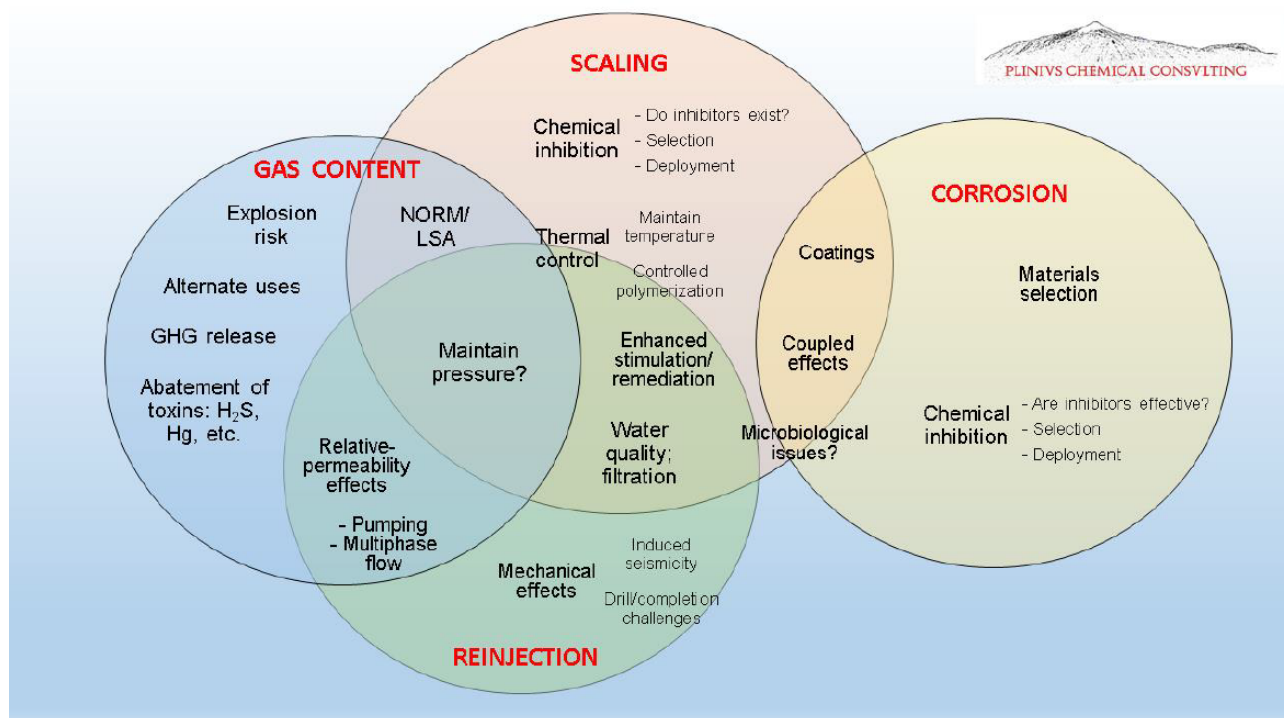

Figure 0-8: Mapping of operation phase issues and interdependencies from the OPERA workshop [16]

The overview in [16] shows typical operational issues (not all of which have been seen in Denmark) in geothermal plants in Denmark, along with Austria, France, Germany, Hungary, Iceland, Italy, the Netherlands, Slovenia and Turkey, and suggests how operational issues can be accommodated to prolong the wells' lifespan and increase the wells uptime and production efficiency. In the Netherlands e.g. the historical average life span of wells appears to be significantly lower than the projected lifetime, owing to a range of different aspects, e.g. poor well-management [13].

Large efforts are put into understanding how to mitigate the risks in the operational phase. Careful initial exploratory analysis before design and installation, e.g. analysis of water chemistry before the final design of the production facility, together with correct operation and maintenance of the plant is crucial to reduce the risks during the operational phase.

There is a risk that injection wells must be re-drilled before the projected plant life of 25 years, thereby adding significant unforeseen costs to the project. High specific flow rates through injection wells have a significant impact on the risk during operation. This can be mitigated by assuming 2 injection wells per production well in this chapter as opposed to the usual doublet system. Further, it is assumed in this chapter that the risk of precipitations and resulting clogging of reservoirs will be reduced by limiting the cooling of geothermal brine to 35 K.

#### Timeline for exploration and construction phase

The construction time in the datasheets is counted from the final investment decision and therefore excludes the project development and exploration phase following the guideline. This, however, adds a significant amount of time to the total time from project initiation to plant commissioning.

The duration of the exploration phase can vary, but it is estimated to be two to three years, and the construction phase two to four years, depending on the size of the plants. Total project time may thus be between five to seven years before the plant is commissioned. The duration of the exploration phase also depends on collaboration between the relevant parties in the process.

For large-scale plants, i.e. plants with approximately 6 production wells and 6 injection wells, the construction time is expected to be around four to five years. The repeatability factor will reduce the time per well significantly by the number of additional wells to be established.

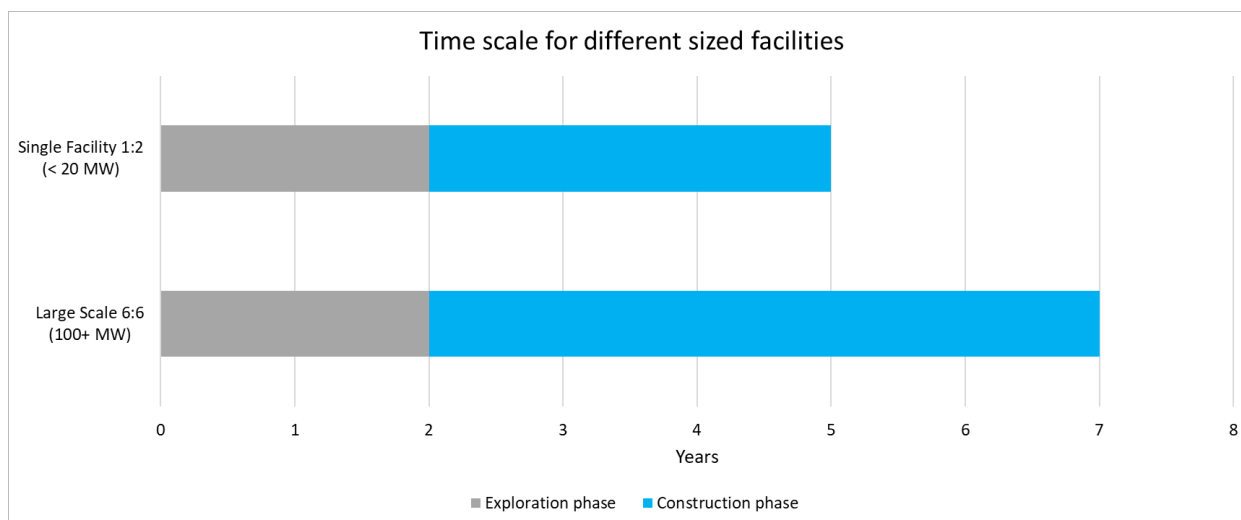

**Figure 0-9 Time scale advantage due to repeatability factor**

Before drilling in the exploration phase, the best well positioning needs to be identified both in terms of the subsurface geology and the distance to the existing DH grid. It may be necessary to re-visit the heat supply plans.

After an exploration well has been drilled, the development will be refined and adapted based on the exploration well's test results. This work can take several months. For plants in a larger series, it may be considered to drill two exploration wells and perform pulse tests between them to map the subsurface between the two wells.

The two to the three-year duration of the exploration phase is partly attributable to a possibly long delivery time on equipment (long lead items). Thus, additional time may be required from when the investment decision is made and the first equipment to the well is ordered until drilling can commence. At the same time, once the investment decision has been made, other activities must be initiated, such as the procurement process and obtaining authority permits.

More information on this subject is found in the subsection about geothermal energy on [www.ENS.dk](http://www.ENS.dk) and [10].

#### Additional remarks

The number of full-load hours for geothermal heating is assumed to be 6,000, according to the guidelines for this technology data catalog.

The number of full-load hours vary; cf. the context of other heat production capacities in which a geothermal plant is operating. E.g. waste incineration or solar thermal would influence the operation strategy of geothermal DH.

European examples of geothermal DH plants (Germany, Poland, Sweden, France, etc.) can be found in [2], [14], and [16].

### Quantitative description

The heat generation costs for geothermal energy depend primarily on geological data (reservoir depth, thickness, permeability and temperature) and the heating system (heat demand, duration curve, and forward/return temperatures). The quantitative description contains data that are expected to represent realistic conditions for geothermal plants in Denmark based on current knowledge and experience. However, it shall be noted that the geological conditions may vary substantially from one site to another.

For the context of this catalog, seven different scenarios for geothermal DH are described, varying by the factors

- heat pump type (absorption or electrically driven),
- reservoir depth with anticipated temperature (1200m/44 °C and 2000m/68 °C)

- supply and return temperature in the connected DH-grid (80/40 °C and 70/35 °C)
- large scale geothermal facility

Thus, scenarios 1 and 2 describe possible plant designs for DH plants with a supply temperature of 80 °C and a return temperature of 40 °C. In scenarios 3.a and 3.b, a system with a supply temperature of 70 °C and 35 °C return is presumed. Scenarios 3.a and 3.b are primarily to be used to evaluate the effect of temperature decreases on the secondary side when comparing 1.a with 3.a and 1.b with 3.b respectively. The assumptions in the given scenarios are collected in the datasheets. In addition, a scenario for a large-scale geothermal plant has been included for comparison. The provided large-scale data are based on one case only and thus it should be expected that the potential well yields may change with the local reservoir characteristics.

The underlying data have been derived from geothermal conditions from six operating geothermal plants (reference plants) where reservoir characteristics are comparable to expected conditions in Denmark<sup>21</sup>. For the large-scale facility, one specific case from Denmark has been applied.

**Table 2: Scenario-overview for described combinations of the geothermal reservoir, heat pumps and DH temperatures.**

| Scen. | Heat pump type |            | Reservoir temp. [°C] |                    | Reservoir depth<br>m | DH temp. [°C]  |                     |
|-------|----------------|------------|----------------------|--------------------|----------------------|--|---------------------|
|       | Electric       | Absorption | T <sub>res</sub>     | T <sub>reinj</sub> |                      | T <sub>supply</sub>                                    | T <sub>return</sub> |
| 1.a   | X              |            | 44                   | 17                 | 1,200                | 80/40  |                     |
| 1.b   |                |            | 68                   | 33                 | 2,000                |  |                     |
| 2.a   |                | X          | 44                   | 17                 | 1,200                |  |                     |
| 2.b   |                |            | 68                   | 33                 | 2,000                |  |                     |
| 3.a   | X              |            | 44                   | 17                 | 1,200                | 70/35  |                     |
| 3.b   |                |            | 68                   | 33                 | 2,000                |  |                     |
| 4     | X              |            | 65                   | 10                 | 2,000                | 90/45 (500 hours), 85/40 (1500 hours) and 80/40 (rest) |                     |

### Energy data

The corresponding energy production data and need for auxiliary energy input have been assessed based on design and operating experiences from the above-mentioned reference plants:

- Production wells:
  - 2 production wells
  - Specific flow: 160 m<sup>3</sup>/hour/well
  - Total flow: 320 m<sup>3</sup>/hour/plant
- Reinjection wells:
  - 4 reinjection wells
  - Specific flow: 80 m<sup>3</sup>/hour/well
  - Total flow: 320 m<sup>3</sup>/hour/plant

<sup>21</sup> Thisted, Neustadt-Glewe, Neubrandenburg, Pyrzyce, Stargard and Torun, in accordance with [14].

For the a-scenarios (1200 m reservoir depth) this results in 9.4 MW<sub>h</sub> heat and for the b-scenarios (2000 m reservoir depth) 12.2 MW<sub>h</sub> power.

Scenario 4 (2000 m reservoir depth) is based on similar reservoir parameters as the above but with 6 production wells and 6 injection wells with similar specific flows. This results in 100 MW<sub>h</sub> power.

The thermal effect in the datasheet is stated as a heat source from the geothermal reservoir for the given amount of wells with a given flow and a given temperature ( $t_{h_{geo}}$ ) and the energy added as drive energy for a heat pump ( $t_{h_{HP}}$ ; electricity for electrical heat pumps or net heat from a boiler for absorption heat pumps).

If the reservoir temperature exceeds the return temperature of the connected DH grid by more than 4 K (assumed loss of a heat exchanger), direct heat exchange is assumed to cover as much as possible of the heat production. The remaining geothermal heat is presumed to function as a heat source for a heat pump.

For electrical heat pumps, the efficiency (COP factor) is calculated using a publicly available tool with a Lorenz efficiency of 50% [15]. The efficiency of heat pump technology is expected to increase with the years according to Ch. 40 in the Technology Catalogue.

**Table 3: Key energy data cf. the technology datasheets.**

| Scen. | Heat pump type |      | DH temp. [°C]  | Thermal power, total | Thermal power, geothermal | Thermal power, heat pumps | Electricity consumption for pumps etc.     |
|-------|----------------|------|--|----------------------|---------------------------|---------------------------|--|
|       | El.            | Abs. | T <sub>supply</sub> /T <sub>return</sub>               | [MW]                 | [MW]                      | [MW]                      | [kWh <sub>el</sub> /kWh <sub>geoth</sub> ] |
| 1.a   | X              |      | 80/40  | 11.4                 | 9.4                       | 2                         | 0.05                                       |
| 1.b   |                |      |  | 13.2                 | 12.2                      | 1                         | 0.08                                       |
| 2.a   | X              |      |  | 22.9                 | 9.4                       | 13.4                      | 0.05                                       |
| 2.b   |                |      |  | 17.7                 | 12.2                      | 5.5                       | 0.08                                       |
| 3.a   | X              |      | 70/35  | 10.9                 | 9.4                       | 1.5                       | 0.05                                       |
| 3.b   |                |      |  | 12.7                 | 12.2                      | 0.5                       | 0.08                                       |
| 4     | X              |      | 90/45 (500 hours), 85/40 (1500 hours) and 80/40 (rest) | 121                  | 100                       | 21                        | 0,08                                       |

The total efficiency for a geothermal plant is calculated as the total heat output divided by the energy input, i.e. the energy input for both heat pumps and auxiliary electricity. The energy consumption for submersible and circulation pumps is assumed in the case of reservoir depth 1200 m to be 0.05 kWh<sub>el</sub>/kWh<sub>geoth</sub> and for reservoir depth 2000 m to be 0.08 kWh<sub>el</sub>/kWh<sub>geoth</sub> as the pumping requirement increases with lower permeability generally expected for deeper reservoirs.

### Financial data

The stated cost and performance data cover the geothermal plant itself, as well as investments in heat pumps. Cost and performance data including learning curve effects for heat pumps have been taken from the relevant chapter of the Technology Catalogue, i.e. heat pumps from Ch. 40. The cost of the electric heat pump is assumed to be 0.67 M€/MW and 0.56 M€/MW for absorption heat pumps. The actual COP factors for electric heat pumps have been calculated, using a publicly available tool [15].

The boundaries for the financial data are outlined in Figure 0-10. In the case of absorption heat pumps the technology to generate the drive energy input is not included. This input can be sourced from existing or new boilers or other technologies that can supply the heat at a sufficiently high temperature. However, as the drive heat is defined as an input it is also included in the output.

The financial data are given based on the total heat capacity (output) delivered by the geothermal plant to the DH system. However, the data is presented so that it becomes transparent which shares of costs relate to heat pumps and which to the geothermal plant itself.

The investment costs for a geothermal plant have been based on actual data from four specific plants, see [14]. Note that investment costs for plants with deeper wells may be considerably higher, as drilling equipment requirements, well dimensions, etc. will increase. Cost for injection- and production wells are estimated to be 1800 €/m for 1200 m reservoir depth and 2000 €/m for 2000 m reservoir depth<sup>22</sup>.

The investment cost for a large-scale geothermal plant has been based on data from one specific plant [Innargi]. Most noteworthy is the repeatability factor which reduces the CAPEX with the added number of wells.

The data sheet 45.4 for large scale plants has been revised to split the costs into the following parts:

- Well and down-hole equipment
- Heat pump incl. installation
- Surface installations excl heat pump

In addition to the above nominal investments an abandonment cost (ABEX) has been added (expected to be approximately 7.5% of the nominal investment) [20]

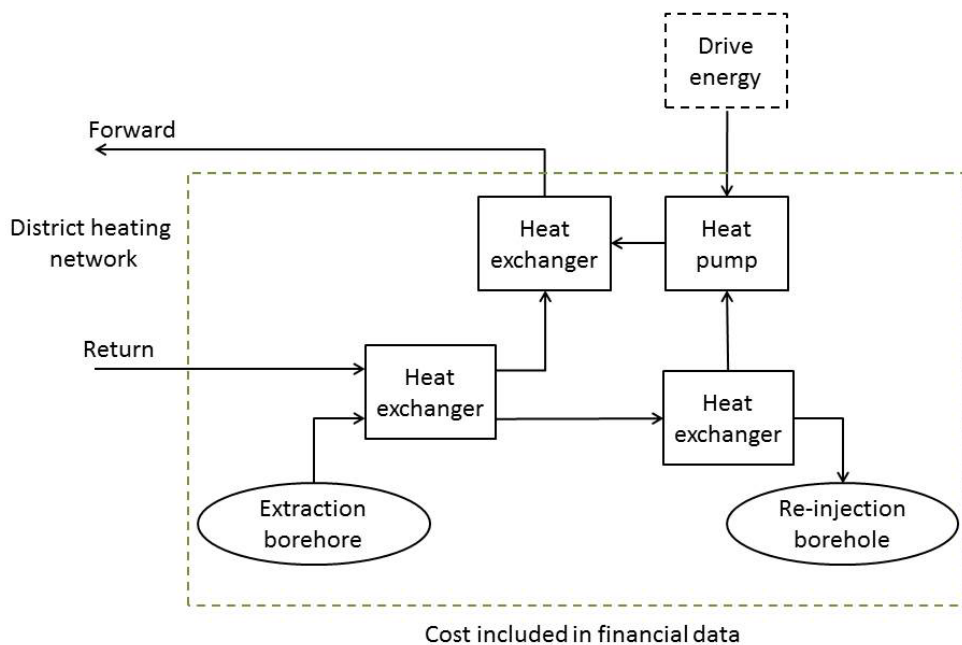

Figure 0-10 Included in financial data in data sheets

**Cost components of a geothermal plant**

<sup>22</sup> Central estimate [14], variations with depth according to [17].



The estimated project cost in 2020, for a 12 MW geothermal plant 1.a - 1,200 m reservoir depth with electrical heat pump, can be seen in Figure 0-11. Note that project development costs are not accounted for in the datasheets, cf. guideline. These are estimated to be 1.5-3 M€/site. Also, the cost differs between the scenarios/datasheets.

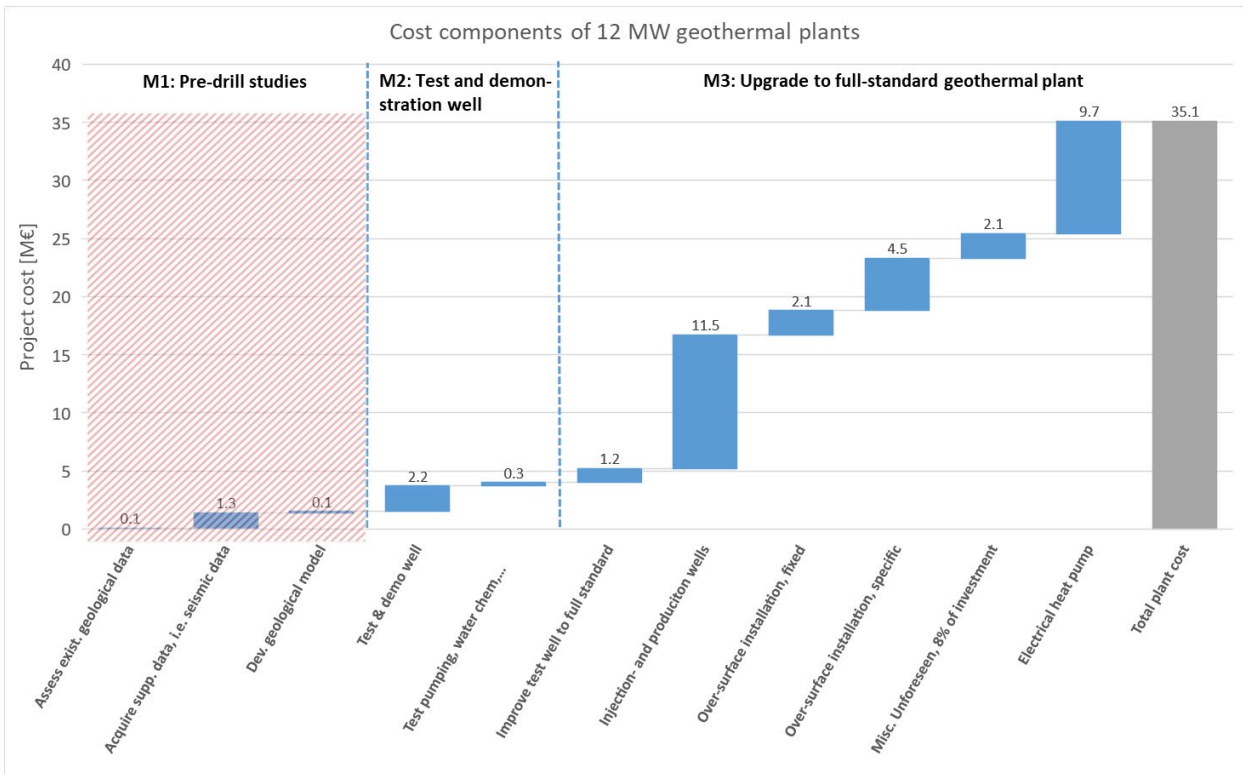

Figure 0-11 Cost components of a 12 MW geothermal plant 1.a - 1,200 m reservoir with electrical heat pump. Definition of milestones (M1-3) is given in [14].



## Definitions

|                       |   |
|-----------------------|---|
| Absorption heat pump: | A heat pump technology using thermal energy as drive energy   |
| COP:                  | Coefficient of Performance of a heat pump at a certain moment of operation. The ratio between energy output and energy input. |
| EGS:                  | Enhanced Geothermal Systems   |
| Electric heat pump:   | Heat pump using electricity as drive energy for a compressor  |
| HDR:                  | Hot Dry Rock  |
| System-COP:           | Coefficient of Performance of the total geothermal / heat pump system, including electricity demand for pumps, etc.           |

## References

- 1 Dansk Fjernvarmes Geotermiselskab, 2011-15, including [www.geotermi.dk](http://www.geotermi.dk)
- 2 European Geothermal Energy Council et al., 2014, *Developing Geothermal District Heating in Europe*, [www.geodh.eu](http://www.geodh.eu)
- 3 European Technology Platform on Renewable Heating and Cooling, 2014, *Geothermal Technology Roadmap*, [http://www.rhc-platform.org/fileadmin/Publications/Geothermal\\_Roadmap-WEB.pdf](http://www.rhc-platform.org/fileadmin/Publications/Geothermal_Roadmap-WEB.pdf)
- 4 Energy Technology Perspectives 2012 – Pathways to a Clean Energy System
- 5 Ea Energianalyse, COWI and Dansk Fjernvarmes Geotermiselskab, 2015, *National Screening of Geothermal Potential for 28 Danish District Heating Systems (DK: Landsdækkende screening af geotermi i 28 fjernvarmeområder)*.
- 6 GEUS, 2009, *Assessment of Geothermal Potentials in Denmark (orig.: Vurdering af det geotermiske potentiale i Danmark)*
- 7 Hovedstadsområdets Geotermiske Samarbejde
- 8 [www.energiforskning.dk](http://www.energiforskning.dk)
- 9 IEA, 2011, *Technology Roadmap Geothermal Heat and Power*
- 10 Dansk Fjernvarmes Geotermiselskab, GEUS, Ross Engineering and Grøn Energi, 2014, *White Paper on Geothermal Energy – Construction and Operation of Geothermal Plants for District Heating (original title: Drejebog om geotermi – Etablering og drift af geotermiske anlæg til fjernvarmeforsyning)*
- 11 Thisted District Heating, 2017, Personal Communication
- 12 Tønder District Heating, 2016, <http://www.tonder-fjernvarme.dk/firmaprofil/geotermi>
- 13 GEUS, 2017, Personal Communication
- 14 Planenergi, GEUS, 2020, Data on investment and operation expenses for Geothermal Energy Production for district Heating in Denmark, ([www.ens.dk](http://www.ens.dk))
- 15 Grøn Energi, Planenergi, DFP, 2017, *Drejebog for store varmepumper i fjernvarmesystemet* ([www.ens.dk](http://www.ens.dk))
- 16 Geothermal ERA NET, 2016, Operational issues in Geothermal Energy in Europe – Status and overview
- 17 A. P. Møller Holding, 2020, Personal Communication
- 18 Gate21, 2018, [https://www.gate21.dk/wp-content/uploads/2018/06/Geotermi-business\\_case\\_EPT.pdf](https://www.gate21.dk/wp-content/uploads/2018/06/Geotermi-business_case_EPT.pdf)
- 19 Ingeniøren, 2018, <https://ing.dk/artikel/ap-moeller-vil-bore-efter-groen-fjernvarme-212949>
- 20 Conversation with Innargi, November 2021

## Supplementary literature

- The European Geothermal Energy Council, [www.egec.org](http://www.egec.org)
- European Technology Platform on Renewable Heating and Cooling, 2012, *Strategic Research Priorities for Geothermal Technology* ([http://www.rhc-platform.org/fileadmin/Publications/Geothermal\\_SRA.pdf](http://www.rhc-platform.org/fileadmin/Publications/Geothermal_SRA.pdf))
- [www.geodh.eu](http://www.geodh.eu), includes a guide, a clickable map and more resources
- [www.geotermi.dk](http://www.geotermi.dk), webpage by Dansk Fjernvarme with information about geothermal power in Denmark.
- [www.geus.dk](http://www.geus.dk), knowledge on subsurface resources
- [www.egec.org](http://www.egec.org), European Geothermal Energy Council, Association based in Brussels representing the geothermal sector in Europe
- [www.geothermalcommunities.eu](http://www.geothermalcommunities.eu), demonstrates the best available technologies in the use of geothermal energy combined with innovative energy-efficiency measures and integration of other renewable energy sources at three different pilot sites (Hungary, Slovakia and Italy)
- Energy Technology Perspectives 2012 – Pathways to a Clean Energy System, pp 490-491 includes an overview of global deployment and investment needs, as well as technology milestones and policy recommendations.
- Dutch TNO has developed an application DoubletCalc, which indicates the nominal values for flow (m<sup>3</sup>/h) and energy potential (MWh) with user input values for the geological properties etc. DoubletCalc is freeware. See <http://www.nlog.nl/en/tools>

## 46 Solar District Heating

### Contact information:

Danish Energy Agency: Filip Gamborg, [fgb@ens.dk](mailto:fgb@ens.dk)

Energinet.dk: Rune Grandal, [rdg@energinet.dk](mailto:rdg@energinet.dk)

Author: Max Guddat, PlanEnergi

### Publication date

October 2018

### Amendments after publication date

| Date | Ref. | Description |
|------|------|-------------|
|      |      |             |

### Brief technology description

Collecting energy from the sun using it to heat water is a technology, which has been in use for many years. Today, more than 580 million m<sup>2</sup> of solar collectors are installed around the globe, with a total installed capacity of 410 GW<sub>th</sub>. Although the majority of this capacity is used for small domestic hot water systems, the fastest growth rate is for large systems (mainly for district heating) [1].

Three different types of solar panels are produced:

- Flat Plate Collectors (FPC) (Basic principle)
- Evacuated Tubular Collectors (ETC)
- Concentrated Solar Power (CSP)

Flat plate large module collectors are by far the most common collector type used for district heat in Denmark. ETC-collectors are more efficient than flat panels at higher temperatures, but also more expensive. CSP can produce heat at high temperatures. It is possible to combine different collector types in one system; e.g. using flat plate collectors in the “cold section” of the field in order to preheat the heat transfer-fluid before evacuated tubes or CSP collectors in the “hot section”. Currently one solar heating plant has both flat plate panels and CSP (Taars). Due to the applicability in the context of Danish district heating, focus in this catalogue is on FPC.

As shown in Figure 1, the principle of flat solar panels in a district heating system is to absorb the solar energy in order to heat a fluid. Corrugated copper or aluminium-sheets serve typically as absorber, with the transfer-fluid being circulated behind these. The absorbers are surrounded by a glass layer, protecting the absorber from the surrounding environment. The back of the panel is insulated, in order to reduce heat loss, cf. Figure 2. The heat is transferred from the circulated fluid to district heating water via a heat exchanger.

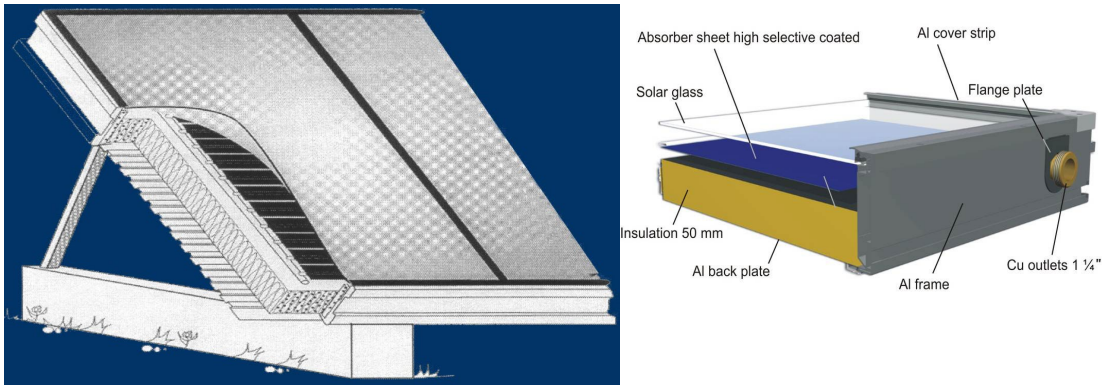

Figure 1 Basic principle of a flat plate solar collector

For district heating systems, the collectors are typically installed on the ground in long rows connected in series. In Danish systems, the solar heating system normally takes in the return water and heats it up to the desired forward flow temperature. All plants have the solar collectors mounted on the ground. Ground mount foundations can be concrete blocks, concrete foundations or steel foundations.

In principle, solar district heating is operating all hours of the year, but of course, the heat production depends on the solar irradiation, weather conditions, time of day and the season of the year. The seasonal variation can be compensated using a seasonal storage. Typical performance of large solar collector fields in Denmark is ca. 450 kWh/m<sup>2</sup>/year. This corresponds to an efficiency of around 40 % (40 % of the solar irradiation is utilized).

**Efficiency and energy yield**

The yield of a solar collector depends on the solar collector type and size, the solar radiation, the temperature of the collectors and the ambient temperature. The efficiency is defined by efficiency parameters, and values for these are available in the Solar Keymark Database [7], [8]. Figure 2 visualises the source of radiation, optical losses and thermal losses of a solar thermal system (FPC).

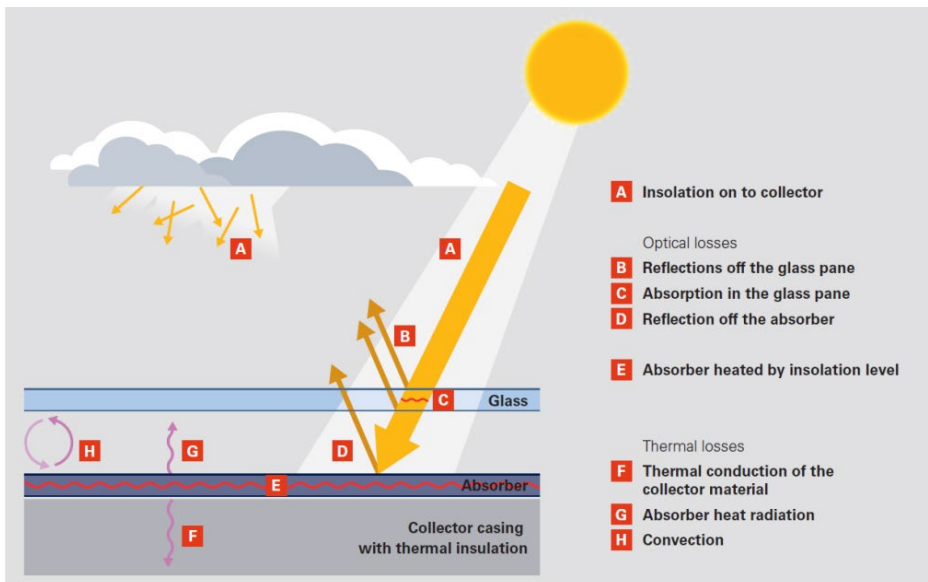
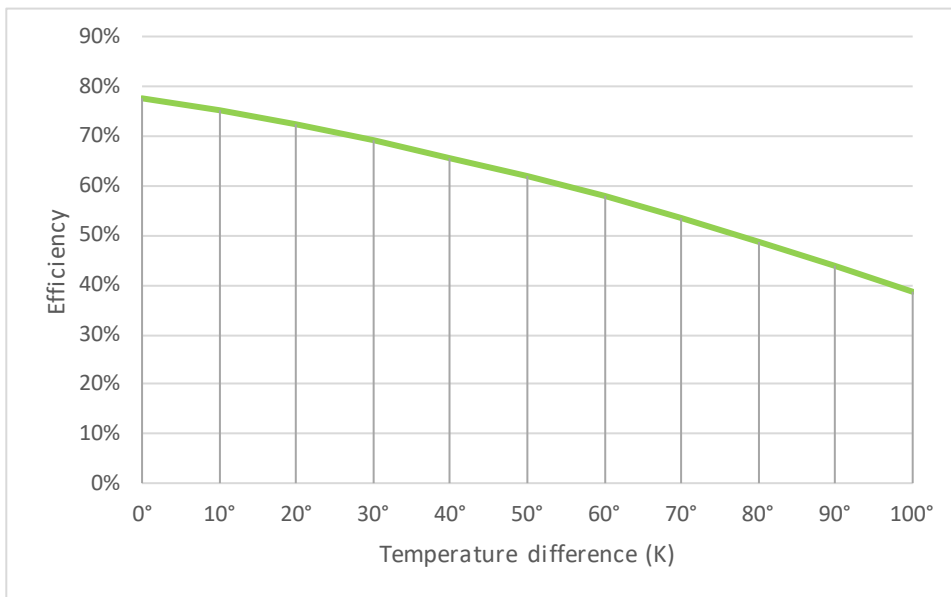

Figure 2 Example of utilisation rate of solar energy and effects influencing the efficiency. [10]

The efficiency of a FPC depends on the temperature difference between the ambient air and the average temperature of the fluids. The lower the temperature difference, the higher the efficiency. Therefore, the thermal performance at a given radiation level is higher at lower temperature differences. The efficiency depends on the flow, since this is how

the temperature difference is controlled. The dependency between efficiency and temperature difference is illustrated in Figure 3.



**Figure 3 Efficiency as a function of temperature difference.**  
(Based on data from [8], example with  $G=1.000 \text{ W/m}^2$ ,  $\eta_0=0.777$ ,  $a_1=2.41$ ,  $a_2=0.015$ )<sup>23</sup>

FPCs are typically produced in two product classes that differ by the energy efficiency of the collectors. Higher efficiencies may be achieved by applying an additional insulating layer, e.g. polymer foil or an extra layer of glass. The SUNSTORE 3-project [15] evaluated the business economic optimal ratio of FPC with/without an extra insulating layer for the solar district heating system for Dronninglund District Heating. In the project it was concluded that under the given circumstances regarding temperature levels, the economic optimum was to only install collectors with an extra insulating layer. In other projects, it is chosen to combine the two levels of insulation, in order to let the less insulated panels preheat the absorber fluid, before boosting it in the better insulated ones. Whether only high efficient or a combination of efficient and high efficient panels are installed, is evaluated from case to case.

The specific yearly thermal output of flat plate solar collectors is around 300-600 kWh/m<sup>2</sup>, with an average of around 450 kWh/m<sup>2</sup> in the years 2012-2015. This shows variation due to solar radiation and site-specific conditions, as well as other aspects [4].

A performance guarantee may be given by the contractor. Fact Sheet 3.3 in [13] describes a method for performance guarantees. A performance guarantee may be given for certain operation situations at given solar radiation and temperatures (mean absorber fluid and outdoor temperatures). However, the guarantees provided by the producers do not ensure yearly specific annual thermal outputs. Yet given the performance guarantees, likely yearly outputs may be assessed quite accurately, when also taking into consideration the uncertainties regarding solar radiation and temperature variations.

### Application of solar thermal systems in district heating systems

A solar thermal plant consists of:

<sup>23</sup>  $G$  = Total (global) irradiance on the collector surface

$\eta_0$  = Maximum efficiency if there is no heat loss (also referred to as the “optical efficiency”).

$a_1$  and  $a_2$  = first and second order heat loss coefficients cf. European Standard EN12975 for efficiency of solar collectors.

- Solar collectors
- Transmission pipeline
- Tank storage
- Tank and collection tank for heat-transfer fluid (e.g. glycol/water)<sup>24</sup>
- Heat exchanger, including pumps, valves etc.
- Integration of control with the existing plant

A schematic drawing of a solar thermal system integrated with a district heating grid can be seen in Figure 4.

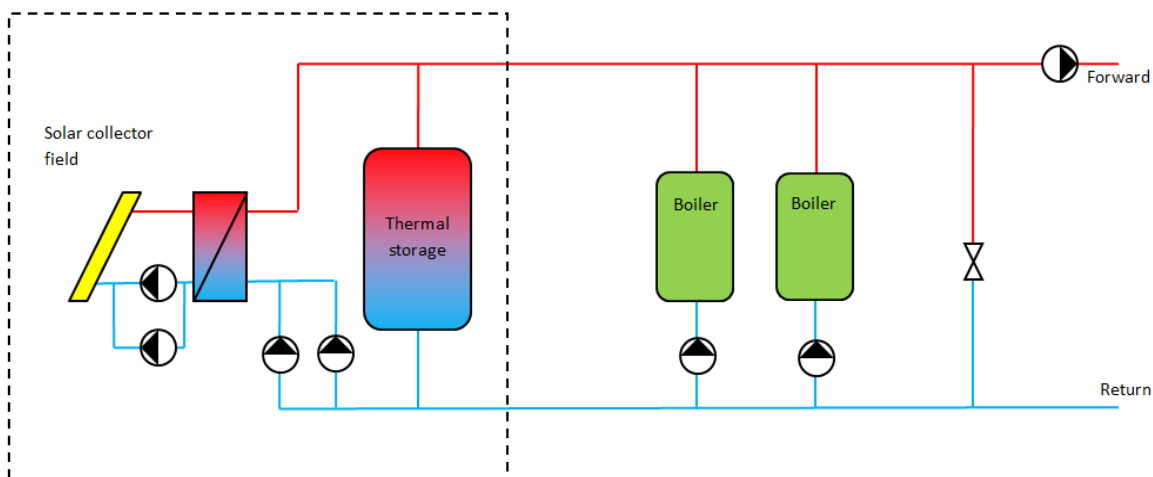

Figure 4 Schematic drawing of a possible system integration of solar district heating [5].

When properly designed, solar collectors can work when the outside temperature is well below freezing, and they are protected from overheating on hot, sunny days.

All district heating systems equipped with solar heating utilize them as a supplement to other heat generating units, thereby ensuring that all consumers' heat demands are met, also when there is insufficient solar irradiation available.

The tilt of the collector panels can impact both annual total yield and production curve production over the year. Hence the tilt of the collector panels becomes an optimization parameter as production can be increased in the autumn at the expense of max. thermal effect and hence production during the summer (where the solar irradiation typically peaks).

Production of solar heating is taking place when the heat demand is lowest – both on daily and seasonal basis. The share of solar heating in a district heating system without heat storage is relatively low (5-8 % of yearly heat demand). Hence, the most common application is the combination of a solar thermal system with a diurnal heat storage, which will enable approximately 20-25 % share of solar district heating in a district heating system. A typical Danish system with a short-term heat storage of 0.1 - 0.3 m<sup>3</sup> per m<sup>2</sup> solar collector covers correspondingly 10 – 25 % of the annual heat demand [4].

Moreover, the combination with a seasonal heat storage can increase the share of solar heating to 30-50 % and in theory up to 100 %. Hence, there is an important synergy with seasonal storage technologies, cf. chapter 60 "Seasonal Heat Storage".

<sup>24</sup> Circulated in the solar thermal collectors. The heat-transfer fluid is typically separated from the district heating water by a heat exchanger, cf. the illustration.

**Input**

The input is solar radiation.

Outside the atmosphere of the Earth, the solar radiation is  $1367 \text{ W/m}^2$  [6]. The solar radiation is highest perpendicular to the solar beams; this is why solar collectors in Denmark are placed with an angle of approximately 30-40 degrees, while also taking into consideration the cast of shadows [13].

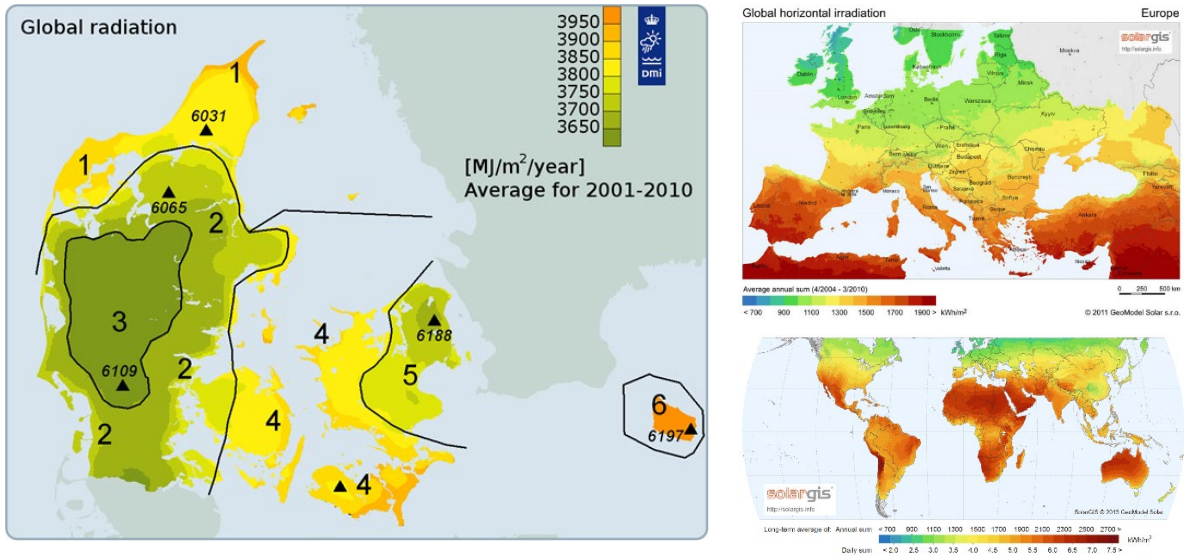

Figure 5 The amount of radiation in Denmark, Europe and the World is illustrated in the maps [6].

As mentioned earlier, the production from solar collectors are highly depended on the seasonal variations of radiation. Figure 6 shows the seasonal variation of the heat generation from a typical solar collector in Denmark as generation in the specific month as the percentage of the average monthly generation.

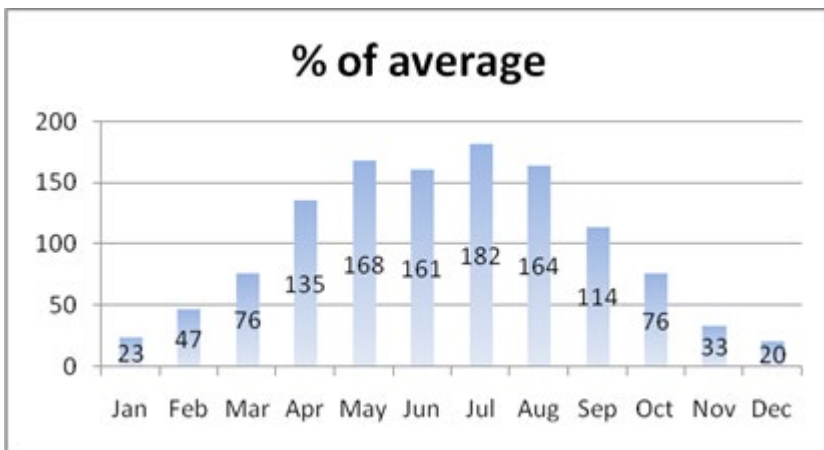

Figure 6 The seasonal variation of heat generation from typical solar collectors in Denmark [3].

**Output**

Hot water for district heating.

The thermal performance of solar heating plants is first of all influenced by the temperature level of the solar collector fluid. Besides that, the thermal performance is also influenced by the weather, the collector type, the solar collector fluid, the flow volume and the collector tilt.

### Typical capacities

The typical application of solar thermal plants for district heating purposes aims at a solar share of 10-25 % of the annual heat demand [4]. Thus, the installed capacity varies by the plant.

Figure 7 shows the development in number of plants and collector area, illustrating that the plants being implemented now is larger than previous plants. Cf. Figure 7 the average plant size has increased rapidly in recent years, indicating two key trends: Larger systems in general and higher solar shares in the plants that decide to invest in solar thermal district heating.

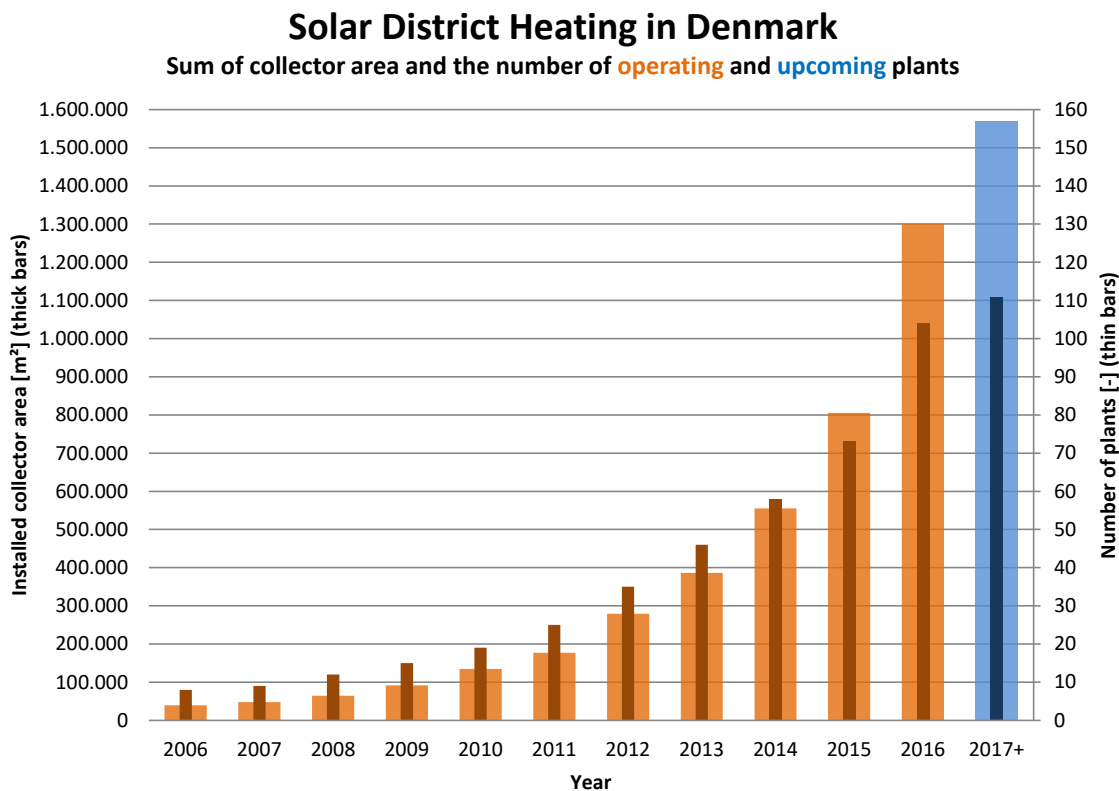

Figure 7 Solar district heating plants in Denmark in operation (until 2017) and planned. The trend is that the new plants are larger and include seasonal heat storages [5].

In the context of the size and heat demand in Danish district heating plants, typical sizes for solar thermal installations are in the range of 5-15,000 m<sup>2</sup>. With increasing plant sizes and/or increased solar coverage share, this figure increases. The biggest plant in operation in Danish district heating grids (as of June 2017) is the solar thermal at Silkeborg District heating at 156,694 m<sup>2</sup>, followed by Vojens with approx. 70,000 m<sup>2</sup> (completed in two steps).

### Examples of best available technology

There are several suppliers of FPC for solar district heating, [14], with the panels from Danish Arcon-Sunmark being the most widely applied option in Denmark. From an international perspective, manufacturers like Austrian GREENoneTEC, TiSUN and Finish SavoSolar offer large FPC-panels too. As of early 2017, there are in total more than 100 plants and 1.3 million m<sup>2</sup> collectors installed in district heating plants around Denmark (while only considering plants sizes >1,000 m<sup>2</sup>). This is a significant increase from less than 100,000 m<sup>2</sup> in 2009. The placement, plant data and production data can be found for several plants in [2] and is visualised in Figure 8.



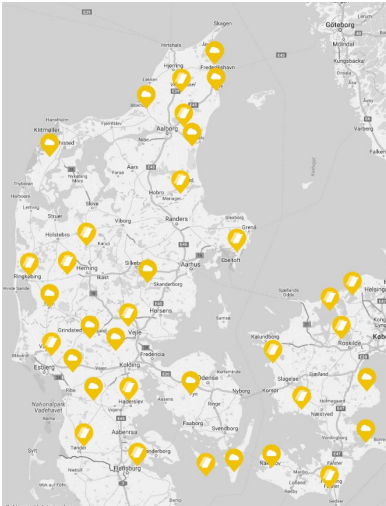

**Figure 8 Solar heating plants in Denmark – more than 100 plants with a total installed collector size of more than 1.3 million m<sup>2</sup>. The map is interactive and includes detailed information on solar heating plants [2].**

Examples of plants are:

- Brædstrup, Denmark: A combined energy system including 18,600 m<sup>2</sup> of solar collectors, 7,500 m<sup>3</sup> heat storage tanks, 19,000 m<sup>3</sup> pilot borehole seasonal heat storage (corresponding to approximately 9,000 m<sup>3</sup> of water), an electrical driven heat pump, an electrical boiler, a natural gas fired engine (combined heat and power production) and natural gas fired heat-only boilers. Also an advanced control system, balancing maximum solar heat and maximum electricity sales. Solar coverage: 22 %. Established in 2007, expanded in 2012 [9].
- Dronninglund, Denmark: Solar panel field of 35,000 m<sup>2</sup>, combined with a seasonal pit heat storage, filled with 60,000 m<sup>3</sup> of water. The pit storage is used to store the heat produced in the summer, to be utilised during the winter. The solar plant yields 16,000 MWh per year and provides 40 % of the heat for the local district heating network with its 1,350 customers. Other heat sources are a natural gas fired engine and a boiler with an absorption heat pump, cooling the storage. The solar district heating (SDH) plant was commissioned in 2014 [9].
- Vojens, Denmark: The experiences made with the 17,000 m<sup>2</sup> large collector field since 2012 convinced Vojens Fjernvarme to plan adding another 52,500 m<sup>2</sup> (36.75 MW<sub>th</sub>) to the field as well as seasonal storage, which should increase the annual solar share from the 14 % measured in 2014 to an expected 45 %. The expansion was commissioned in May 2015 [9].
- Silkeborg, Denmark: Solar panel field of 156,694 m<sup>2</sup>. Commissioned late 2016, making it the world’s largest SDH-plant at the time. Other heat sources in the system are natural gas fired CHP, an electric boiler and industrial excess heat.

An overview of the World’s largest installations can be found in [9] and [14].

### Research and development objectives

More suppliers have entered the market in Denmark, offering different technologies. This implies that there is a process of improvement of the efficiency of the panels as well as reduction of the costs of the panels.

Examples of research and development objectives include:

- Production of panels – e.g. extruded absorber aluminium panels (Savo-Solar)
- Absorbers – increased absorbance and reduced emittance
- Improved absorber design – increased heat transfer to fluid and better flow distribution
- Use of concentrating collectors (CSP)
- Improved plant layout – serial connection of different collector types in rows and optimised serial/parallel connections for solar collector fields
- Control strategies – optimised integration of solar in existing district heating plants

Additionally, [4] contains an extensive list of possible development aspects of solar heating.

### Regulation ability and other system services

Regulation with regard to electricity is not relevant for solar thermal plants.

There are however other relevant regulation aspects for solar thermal collectors, e.g. the possibility to vary the flow of the absorber fluid. By varying the flow of the absorber fluid, the temperature in the plant can be regulated. This is especially important, considering the variation in intensity of solar radiation. Varying the flow secures the possibility to optimize the flow rate according to the external circumstances and desired output temperature.

Boiling of the absorber fluid can cause reduction of the corrosion protection. Ways to avoid boiling are the installation of conventional cooling towers or the scheduled and preventive cooling of stored heat by circulating water through the plant at night. The latter is applied in many Danish plants, as it reduces the installation costs, but the cooling capacity of collectors is practically limited to FPC-technology and has decreased in recent years, due to the increased energy efficiency of collectors.

In the event that the thermal solar district heating plant is oversized compared to the available cooling capacity, the absorber fluids remains at risk of boiling.

### Advantages/disadvantages

#### Advantages:

- Simple, robust and proven technology. More than 100 Danish district heating plants have solar thermal plants
- Long technical lifetime, proven at least 25-30 years
- Low maintenance costs, based on current plants approximately <math><1 \text{ €/MWh}\_{\text{th}}</math> [11]
- Low electricity consumption required (3-4 kWh pr. produced MWh solar heating, primarily electricity consumption for circulation pumps) [11]
- No continuous presence of operation personnel required during operation
- Heat production price not sensitive to variable costs of fuel, easier budgeting of the heat price, when a share of the heat price is known
- CO<sub>2</sub>-free energy source
- High energy yield pr. occupied land-area compared to e.g. biomass, in terms of possible energy production on a given area
- Easy reestablishment of area, no or low impact on the soil from the foundations
- Approx. 98 % of a plant can be recycled after decommission [12]
- Can be combined with heat pumps to increase yields

#### Disadvantages:

- Production dependent on solar radiation and weather conditions
- Summer load defines the size of the capacity in case of diurnal storage only
- Produces approx. 80 % of the heat energy during the period April – September, when the heat demand is lowest. Can be mitigated by including a seasonal heat storage [3]
- High area occupation, compared to other district heating technologies like boilers or heat pumps, approximately 3 m<sup>2</sup> ground area for each m<sup>2</sup> solar panel collector, near by the district heating network – although this can be mitigated with a transmission pipeline e.g. some km, which may imply additional costs
- High initial investment pr. MW, but with a depreciation period of 15-20 years, the heat production cost is competitive with e.g. biomass based heat production.

### Environment

No emissions related to the heat production.

Anti-freezing agents such as organic glycols are typically added to the water in the system, in order to avoid frost damages in the winter. Leakage risks can be mitigated by installing monitoring systems, monitoring e.g. pressure in the system as well as moisture in the insulation material of the pipes.

The basic components of solar thermal collectors consist of metals, insulation material, glass and the above-mentioned anti-freezing agents. Thus, most of the used materials can be recycled after decommission.

### Assumptions and perspectives for further development

Solar district heating has developed significantly during the recent years towards category 4 “Commercial, limited development potential”. This is illustrated by the significant deployment of solar district heating cf. Figure 7. Figure 9 visualizes the technological development phases for solar thermal.

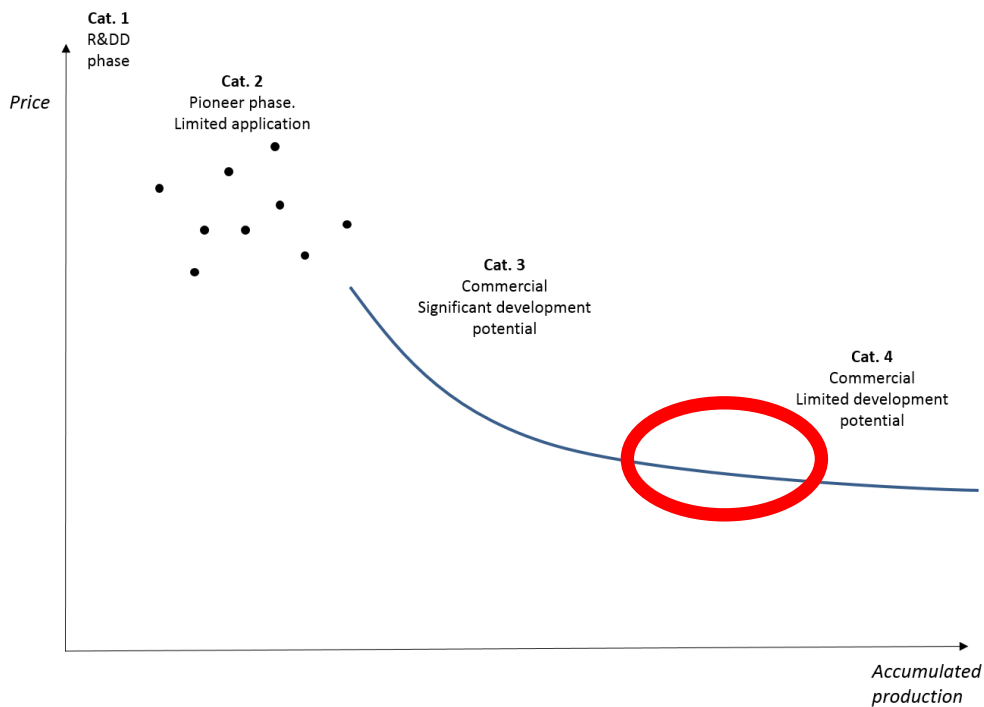

Figure 9 Technological development phases. Correlation between accumulated production volume (MW) and price.

There has been an increase of efficiency of production of solar thermal panels through automation. During the past decade, the production of solar panels has matured, resulting in lower production costs, which results in better business cases for the district heating utilities, due to a reduction in investment costs.

The cost of installation has been reduced by applying steel profiles instead of concrete foundations. This enables faster installation and is independent on the weather conditions at the time of installation – both these parameters contribute towards a reduction of the installation costs.

Design of the solar fields is another parameter, which can imply further reduction of the investment costs.

The yield of the solar panels has improved substantially during the past decade. This is due to various improvements in the materials and the elimination of thermal bridges that have improved the efficiency.

A potential for further development of solar district heating is control of the operation of the solar plants, i.e. flexibility. This relates to the role of solar district heating as one element in a complex system of different production and storage technologies – even at the same plant – thus efficiently utilizing the solar energy, while efficiently fulfilling the heat demand. The flexibility also includes meeting demands at lower supply temperature – which would improve the efficiency of the solar panels (cf. Figure 3).

The development potentials for solar thermal plants and how they are expected to influence the market situation for solar district heating are characterized by:

- Increased applications of solar district heating systems internationally
- Solar thermal with large storages (Economy of scale and increased independency of fluctuations in energy prices due to increased substitution of conventional heat production)
  - Leading to up to 80 % solar fraction of yearly heat demand
- More suppliers (an increased number of competitors is expected to result in increased development and competition):
  - Cf. the overview of suppliers in [4]

- Combination of solar thermal and biomass for 100% RES-district heating systems
  - Solar thermal already is business economically feasible in combination with wood chips and straw (including "energy saving" subsidy)
  - If designed correctly, SDH-plants can improve the operation of other heat producing capacity in the summer time, by covering the entire heat demand and thus eliminating inefficient part-load-operation etc.
- Other hybrid systems
  - Combinations with other technologies such as long term storages and heat pumps
- Solar thermal for large cities (Economy of scale and increased attention to these kinds of projects):
  - Graz; 265,000 inhabitants, 450,000 m<sup>2</sup> solar panels, 2.0 million m<sup>3</sup> storage
  - Silkeborg, 156,694 m<sup>2</sup> solar panels
  - Belgrade – under investigation
- Solar with higher temperatures (new product developments):
  - Supply of industrial heat demands (i.e. for process energy demands)
    - E.g. CSP (concentrated solar power) and ORC (organic rankine cycle)

The correlation between the collector area and investments costs of solar heating plants in Denmark can be seen in Figure 10.

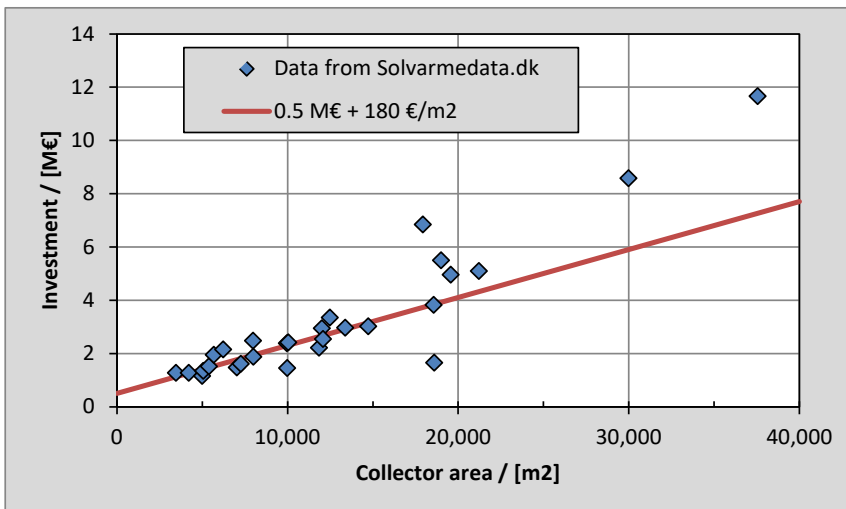

Figure 10 Solar plant investment for Danish SDH projects. The plant in the upper right corner is "Dronninglund" with 37,573 m<sup>2</sup> which includes a seasonal heat storage – and the investment for that is 2.4 M€ (see the section below on the seasonal heat storage), bringing this plant closer to the red line [5].

Different suppliers provide different quality at different prices. There seem to be a balance between quality and price, resulting in heat production prices on the same level due to different yields. Hence, there is increasing competition between suppliers, resulting in improved quality and lower prices.

As shown in Figure 10, there is a close correlation between investment costs and solar collector area for plants with a collector area below 15,000 m<sup>2</sup>. When considering the investment costs of thermal solar plants with a collector area above 15,000 m<sup>2</sup> the investment costs is increasing faster than what is predicted by the regression line (the red line). This is predominantly because the larger plants include a seasonal heat storage (for example when considering the plant in the upper right corner, Dronninglund with a collector area of 37,573 m<sup>2</sup> and a seasonal heat storage). The investment

for the seasonal heat storage alone is approx. 2.4 M€ (cf. Section 1.1.11, on *additional remarks* regarding the seasonal heat storage).

In conclusion, the above considerations illustrate that solar thermal is a well-proven and robust technology with a long technical lifetime. Solar thermal district heating is also competitive in large-scale applications in combination with other technologies, including seasonal heat storage technologies. The development potential for energy yields and cost reductions are estimated to be limited.

### Uncertainty

Solar thermal plants are a low risk technology, which has matured in terms of reduction of production costs and improvement of the yield of the solar panels during the past few years. Consequently, the uncertainty on the provided parameters is considered small.

### Additional remarks

Relevant sources of information includes:

- Factsheets from the IEA SHC Task 45 Project, [www.Task45.iea-shc.org](http://www.Task45.iea-shc.org)
- Guidelines developed in the Solar District Heating Project, <http://solar-district-heating.eu/Documents/SDHGuidelines.aspx>, i.a. detailed technical descriptions and considerations regarding operation economy and organization of an SDH-plant
- [www.solvarmedata.dk](http://www.solvarmedata.dk) and [www.solarheatdata.eu](http://www.solarheatdata.eu), include data on specific plants
- Homepages of suppliers. Please refer to <http://solar-district-heating.eu/ServicesTools/FindProfessionals.aspx> for a list of suppliers.

Some district solar heating systems also have seasonal heat stores (cf. chapter '60 Seasonal heat storage'). Under Danish climatic conditions, a district heating system, which is based entirely on solar energy, needs a seasonal store with a volume of about 4 m<sup>3</sup> per m<sup>2</sup> of solar collector, provided a heat pump is installed to extract the heat energy from the storage. This ratio is based on a 50° C temperature difference  $T_{out} - T_{in}$  of the storage water.

Figure 11 shows calculated data for the seasonal storage requirement as a function of solar heat coverage in the DH system, based on the data sheet below and data for seasonal heat storage in this publication technology catalogue, chapter 60 on seasonal heat storage.

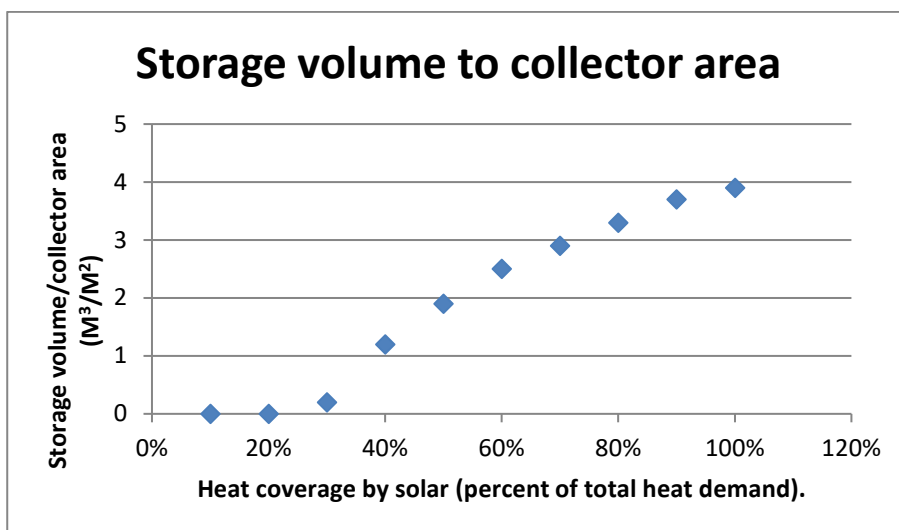

Figure 11 Ratio of seasonal storage volume to collector area (y-axis) as a function of solar heat coverage [4] and [5].



## Data sheets

| Technology  | Solar District Heating |       |       |       |                    |                    |              |              |         |    |
|---|------------------------|-------|-------|-------|--------------------|--------------------|--------------|--------------|---------|----|
|   | 2015                   | 2020  | 2030  | 2050  | Uncertainty (2020) | Uncertainty (2050) | Note         | Ref          |         |    |
| <b>Energy/technical data</b>  |                        |       |       |       | <b>Lower</b>       | <b>Upper</b>       | <b>Lower</b> | <b>Upper</b> |         |    |
| Typical plant size (collector area), m <sup>2</sup>   | 10000                  | 13000 | 21000 | 55000 | 10000              | 20000              | 10000        | 100000       | L       |    |
| Collector input, kWh/m <sup>2</sup> /year   | 1046                   | 1046  | 1046  | 1046  | 1013               | 1079               | 1013         | 1079         | Q       |    |
| Collector output, kWh/m <sup>2</sup> /year  | 450                    | 473   | 497   | 522   | 450                | 496                | 497          | 548          | A       | 4  |
| Total efficiency, net (%), annual average   | 43%                    | 45%   | 48%   | 50%   | 42%                | 49%                | 46%          | 54%          | P       |    |
| Auxiliary electricity consumption (share of heat gen.)  | 0.3%                   | 0.3%  | 0.3%  | 0.3%  | 0.2%               | 0.4%               | 0.2%         | 0.4%         |         |    |
| Forced outage (%)   | 0.5%                   | 0.5%  | 0.5%  | 0.5%  | 0%                 | 1%                 | 0%           | 1%           | K       |    |
| Technical lifetime (years)  | 30                     | 30    | 30    | 30    | 30                 | 30                 | 30           | 30           | I       | 17 |
| Construction time (years)   | 0.25                   | 0.25  | 0.25  | 0.25  | 0.25               | 0.25               | 0.25         | 0.25         |         |    |
| Space requirement (1000m <sup>2</sup> per MWh/year)   | 6.7                    | 6.3   | 6.0   | 5.7   | 6.0                | 6.7                | 5.5          | 6.0          | J       |    |
| <b>Environment</b>  |                        |       |       |       |                    |                    |              |              |         |    |
| SO <sub>2</sub> (g per GJ fuel)   | 0                      | 0     | 0     | 0     | 0                  | 0                  | 0            | 0            |         |    |
| NO <sub>x</sub> (g per GJ fuel)   | 0                      | 0     | 0     | 0     | 0                  | 0                  | 0            | 0            |         |    |
| CH <sub>4</sub> (g per GJ fuel)   | 0                      | 0     | 0     | 0     | 0                  | 0                  | 0            | 0            |         |    |
| N <sub>2</sub> O (g per GJ fuel)  | 0                      | 0     | 0     | 0     | 0                  | 0                  | 0            | 0            |         |    |
| <b>Financial data</b>   |                        |       |       |       |                    |                    |              |              |         |    |
| Investment cost of total solar systems excluding diurnal heat storage, €/MWh <sub>output</sub> /year      | 429                    | 395   | 362   | 325   | 371                | 422                | 292          | 362          | C, H, N |    |
| - of which is equipment   | 85                     | 85    | 85    | 85    | 85                 | 85                 | 85           | 85           | O       |    |
| - of which is installation  | 15                     | 15    | 15    | 15    | 15                 | 15                 | 15           | 15           | O       |    |
| Investment cost of diurnal heat storage, €/MWh <sub>output</sub> /year                                    | 60                     | 57    | 54    | 52    | 41                 | 75                 | 37           | 68           | D, M    |    |
| Total investment cost of total solar system including diurnal heat storage, €/MWh <sub>output</sub> /year | 489                    | 452   | 416   | 377   | 412                | 497                | 329          | 430          | E       |    |
| Fixed O&M €/MWh <sub>output</sub> /year/year  | 0.09                   | 0.09  | 0.08  | 0.08  | 0.08               | 0.10               | 0.07         | 0.08         | B       |    |
| Variable O&M €/MWh <sub>output</sub>  | 0.19                   | 0.21  | 0.30  | 0.35  | 0.14               | 0.28               | 0.23         | 0.47         |         |    |
| - of which is electricity costs, €/MWh <sub>output</sub>  | 0.19                   | 0.21  | 0.30  | 0.35  | 0.14               | 0.28               | 0.23         | 0.47         |         |    |
| - of which is other O&M costs, €/MWh <sub>output</sub>  | 0                      | 0     | 0     | 0     | 0                  | 0                  | 0            | 0            |         |    |
| <b>Technology specific data</b>   |                        |       |       |       |                    |                    |              |              |         |    |
| Investment cost of total solar systems excluding diurnal heat storage, €/m <sup>2</sup> (collector area)  | 193                    | 187   | 180   | 170   | 184                | 190                | 160          | 180          | G, H, N | 16 |
| Fixed O&M, €/m <sup>2</sup> /year (collector area)  | 0.04                   | 0.04  | 0.04  | 0.04  | 0.04               | 0.05               | 0.04         | 0.04         | B       |    |



**Notes**

- A The yield is weather dependent and very site-specific, depending much on the temperatures of the district heating network. The quoted yield the average measured output from 40 Danish solar heating plants for 2015.
- B Estimate is 0,2 €/MWh heat output in 2015, excluding electricity consumption.
- C Applying the formula 250,000 € + 167 €/m<sup>2</sup> solar panel collector for plants <50.000m<sup>2</sup>, cf. figures from Note G.
- D Including a diurnal storage is mandatory, 0.2 m<sup>3</sup>/m<sup>2</sup> being a typical average storage size. This figure can vary, dependent on the local conditions and desired solar fraction.
- E Can be combined with seasonal storage, cf. corresponding chapter.
- F Solar thermal plants can be regulated by varying the flow of the heat transfer fluid. The regulation ability is limited by the available heat demand in the heat sink (incl. available storage capacity) and solar radiation.
- G 2015-Prices of different plant sizes [1]:

|                          |                  |       |        |        |        |         |
|--------------------------|------------------|-------|--------|--------|--------|---------|
| Size                     | m <sup>2</sup>   | 5,000 | 10,000 | 20,000 | 50,000 | 100,000 |
| Price pr. m <sup>2</sup> | €/m <sup>2</sup> | 216   | 193    | 180    | 175    | 170     |
| Total price              | M€               | 1.08  | 1.93   | 3.60   | 8.73   | 17.00   |

- H Prices include leveling of ground, laying of district heating pipelines in the ground inkl. 50 m of transmission pipeline to the district heating plant, heat exchanger connected to solar panel field and installed with collection tank and expansion with flanges to secondary side, control and electricity works, design and project management, start-up regulation and documentation.
- I The lifetime is minimum 25-30 years, proven in actual plants still in operation. Critical component is the teflon foil, not the material itself, but the application method. The pipes have been improved, designed for the relatively large number of temperature variations, compared to normal district heating pipelines. The fluid is well managed.
- J Space requirement is approximately 3 m<sup>2</sup> for each m<sup>2</sup> gross collector area. No development of this parameter is expected, since the main reason is to avoid the shadow effect. Minor optimization of the sides of the panels may be obtained, increasing the ratio of aperture/gross area. Other types of solar collectors such as vacuum and CSP (concentrated solar power) may have lower space requirement.
- K The forced outage is very small, therefore in practice close to 0 %. The modular construction makes it possible to maintain sections of the panels. Outage of critical components such as the heat exchanger is very limited.
- L The average plant size increases, but with large variations since both small plants and increasingly larger plants are installed. A 5 % annual increase of the average size is assumed. The plant size is rather dependent on the heat demand in the district heating grid, it is connected to. The collector area is, cf. international standards, stated as gross area.
- M Estimate of cost of tank storage (diurnal storage) is 135 €/m<sup>3</sup>. The required size of the storage differs, but a typical size is 0.1-0.3 m<sup>3</sup> storage for each m<sup>2</sup> of solar panels, hence a 10,000 m<sup>2</sup> solar thermal plant requires 1-3,000 m<sup>3</sup> of diurnal storage.
- N Considering a reduction in prices for 2015-2020 / 2020-2030 / 2030-2050 of 0.6 / 0.4 / 0.3 % p.a.
- O The division of cost elements is site- and plant specific. An indicative distribution of costs are; Solar collectors and piping (48%), heat exchanger, pumps etc. (8%), accumulation tank (11%), transmission pipeline (13%), building (2%), control, operation and startup (5%), land purchase, ground works (7%), design, permits, unforeseen (6%). Total for equipment is 85% and for installation is 15% (design, permits, unforeseen, ground works, control and start up), but including accumulation tank and a transmission pipeline.
- P Please refer to [www.solvarmedata.dk](http://www.solvarmedata.dk) for display of efficiencies of Danish solar district heating plants. Chose a plant, select "Production and efficiency" and a chart will display the efficiency - typically varying between 20 and 50%.
- Q The solar radiation on the horizontal surface.
- R The cost of auxiliary electricity consumption is calculated using the following electricity prices in €/MWh: 2015: 63, 2020: 69, 2030: 101, 2050: 117. These prices include production costs and transport tariffs, but not any taxes or subsidies for renewable energy.

**Definitions**

|                           |   |
|---------------------------|---|
| CSP                       | Concentrated Solar Power  |
| ECT                       | Evacuated Collector Tubes   |
| FPC                       | Flat Plate Collector  |
| SDH                       | Solar District Heating  |
| Specific collector output | Heat production pr. gross collector area (e.g. kWh/m <sup>2</sup> ) |

## References

- [1] <http://www.iea-shc.org/solar-heat-worldwide>
- [2] [www.solvarmedata.dk](http://www.solvarmedata.dk)
- [3] [www.climateminds.dk](http://www.climateminds.dk)
- [4] Yearly thermal performance of solar heating plants in Denmark - measured and calculated. *Solar Energy* 159C, pp. 186-196, 2018. Simon Furbo, Janne Dragsted, Bengt Perers, Elsa Andersen, Federico Bava, Kristian Pagn Nielsen
- [5] PlanEnergi, [www.planenergi.dk](http://www.planenergi.dk)
- [6] GHI Solar Map 2017 Solargis, [www.solargis.com](http://www.solargis.com)
- [7] IEA-SHC TECH sheet 45.A.1
- [8] [www.solarkeymark.dk/CollectorCertificates](http://www.solarkeymark.dk/CollectorCertificates)
- [9] [www.solarthermalworld.org](http://www.solarthermalworld.org)
- [10] Viessmann GmbH, 2009, *Technical Guide – Solar Thermal Systems*
- [11] Marstal District Heating
- [12] Jan-Olof Dalenbäck, 2014, *Presentation in the SDH-project Solar District Heating Systems State of the Art*
- [13] SDH Guidelines, developed in the SDH-Project. <http://solar-district-heating.eu/Documents/SDHGuidelines.aspx>
- [14] Homepage of the SDH-project, overview of professional partners in the SDH-branch, <http://solar-district-heating.eu/ServicesTools/FindProfessionals.aspx>
- [15] PlanEnergi et. al, 2015, *SUNSTORE 3 Final Report - Phase 2 - Implementation*
- [16] Arcon-Sunmark, personal communication. The projected costs are not from this reference, but estimated based on two components; the lower specific costs of larger plants in 2015 and increased competition among suppliers and more efficient production of solar panels.
- [17] "Life expectancy of solar collectors in solar district heating systems", Department of Civil Engineering, Technical University of Denmark, 2009.

## Introduction to Peak Power Plants and Reserve Technologies

### Contact information:

Energinet.dk: Rune Grandal, [rdg@energinet.dk](mailto:rdg@energinet.dk)

Danish Energy Agency: Filip Gamborg, [fgb@ens.dk](mailto:fgb@ens.dk)

Author: Ea Energy Analyses

### Publication date

November 2018

### Amendments after publication date

---

| Date | Ref. | Description |
|------|------|-------------|
|------|------|-------------|

## Introduction

This chapter covers data regarding energy plants designed for providing of peak power either in the wholesale market or reserve capacity for the system operator.

The focus is on newly built thermal power plants. Other technologies may in the future provide the same service, such as storage technologies or demand response. However, these technologies are not treated here nor compared to thermal peak power plants. Some of these technologies (e.g. electrical energy storage) are described in a separate technology catalogue.

It is intended as a specific chapter of the *Technology Data for Energy Plants*, thus follows the same structure and data format. The chapter focuses on the assumptions that differ from the main catalogue.

This section provides an introduction, a definition of the services covered and some general assumptions. Each technology is subsequently described in a separate technology chapter. The technology chapters contain both a description of the technologies and a quantitative part including a table with the most important technology data. For some of the technology chapters, the qualitative technology description is brief and only focuses on the specific service described. For additional information, see the respective technologies in the main catalogue (e.g. simple-cycle gas turbines and gas engines).

## Definition of the services

The services that are covered in this chapter refer to provision of peak load and reserve.

The **peak load** service, provided by the peak power plants - also referred to as peakers - is defined as the provision of power in the hours with the highest price. It is characterized by few operating hours and is therefore served with technologies characterized by:

- Low capital expenditure (CAPEX)
- High variable cost, mainly in relation to high fuel cost
- Low start-up costs and quick start-up time

The peak power plants regularly bid into the market and appears on the right-hand side of the supply curve as the last units available, due to their high short-term marginal cost. A representation of a potential merit order curve is shown in Figure 1.

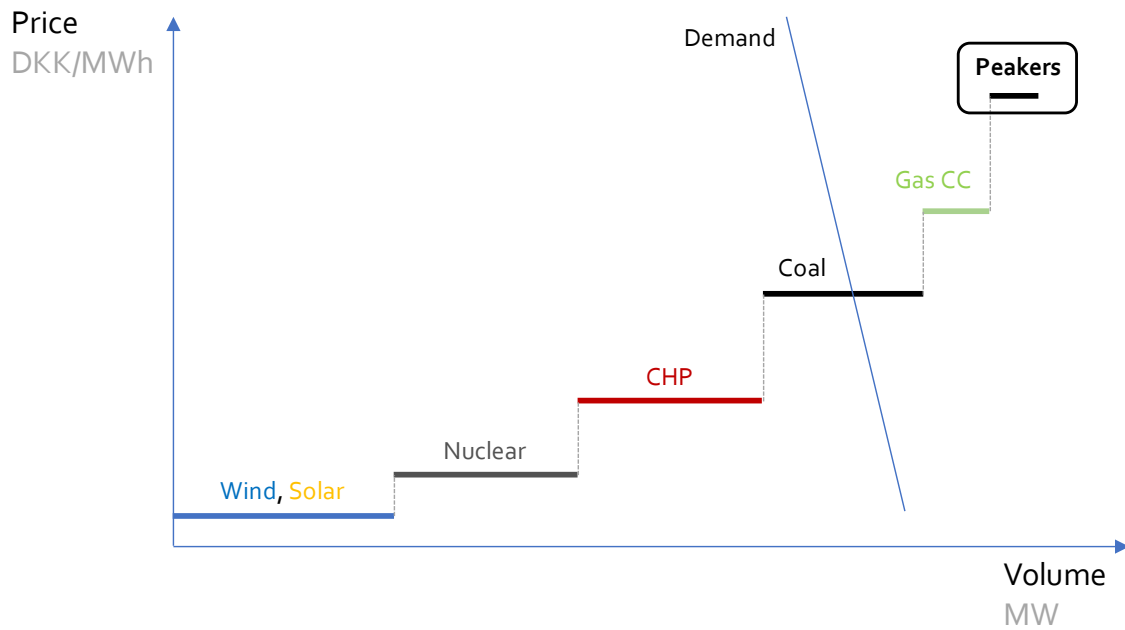

Figure 1 Example of a supply curve (merit-order curve), in which peakers appear on the right side

Figure 2 shows the price duration curve in DK1 and DK2 and a zoom on the highest price hours in DK2. In 2017, the 200 hours with the highest price were all above 57 €/MWh, with peak price of around 120 €/MWh.

With an increasing penetration of variable renewable energy sources (VRES) and a decommissioning of more conventional and dispatchable power plants, it is expected that hours with a high electricity price will increase making more room in the system for peak technologies.

The plants providing this type of service have also the opportunity to participate to balancing markets held by the TSO.

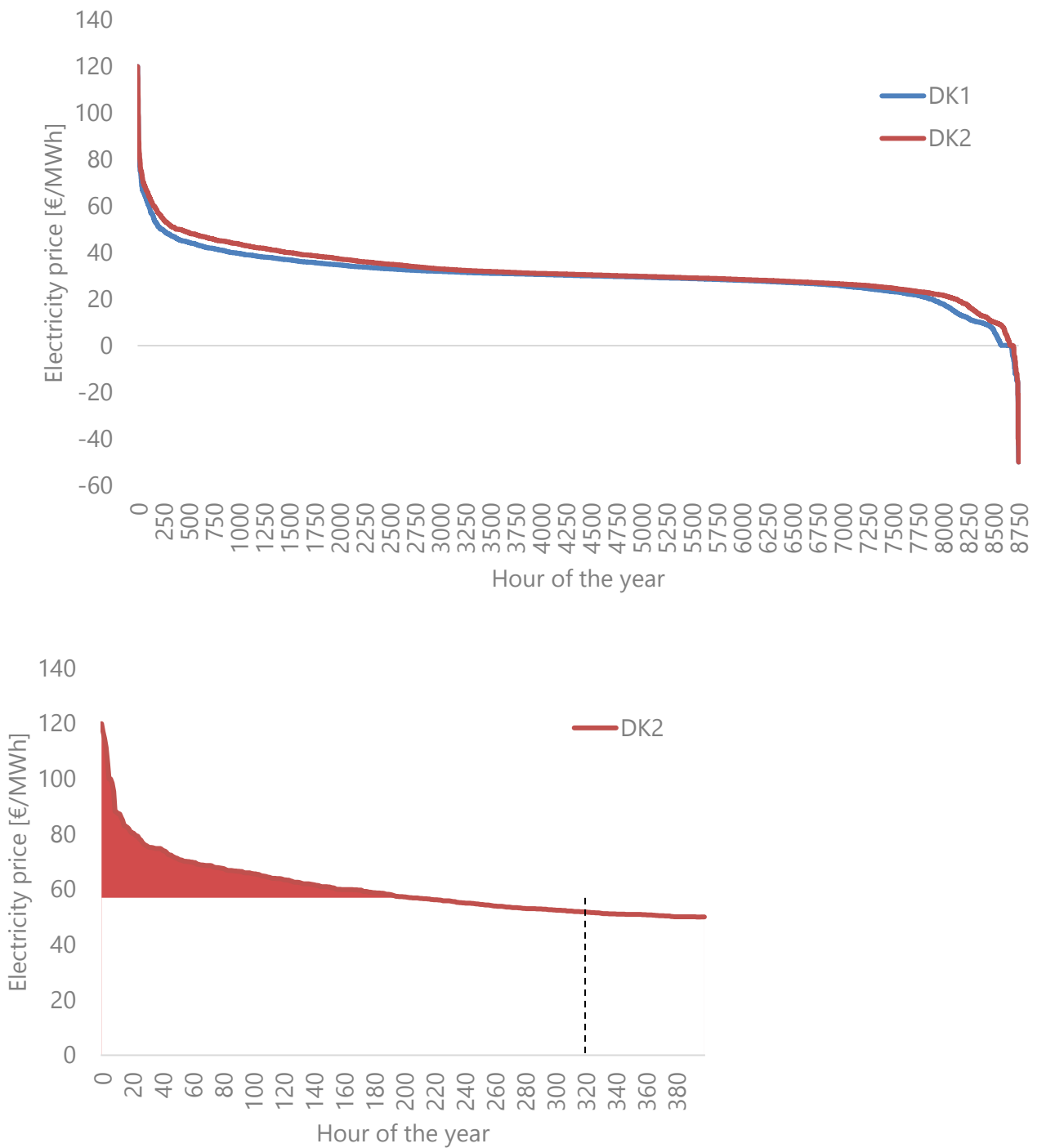

Figure 2 Price duration curve for DK1 and DK2 bid areas (top) and price in the 200 hours with highest price in DK2 (bottom). Data for the year 2017 [1].

The **reserve service (or emergency service)** has similar technical requirements compared to the peak load serving, i.e. fast response and low capital expenditure. However, the reserve service is characterized by the fact that generator offering this service does not bid into the day-ahead but, instead, make their generation capacity available to the

Transmission System Operator (TSO) in case lack of generation or failures in the transmission network triggers a risk for security of supply.

An example of such a service is the strategic reserve adopted in some Nordic countries (Sweden and Finland) and planned in Eastern Denmark (DK2).

The strategic reserve is intended to operate only when the market does not provide sufficient capacity and should therefore be dispatched at a price above a reference level signaling scarcity. In theory, the reserve should only be dispatched at a price close to VoLL (value of lost load) in order not to interfere with the market. In this case the natural price formation on the market is not affected and generators receive the same investment incentive as if there were no strategic reserve.

Capacity for strategic reserves is procured through a tendering procedure for a specified amount of capacity (in MW), for example on a year-to-year basis. The strategic reserve may consist of existing or - provided the auction takes place well in advance of when the contracted capacity should be available - new generation built for the purpose of reserve capacity. The specification of the amount and type of capacity (e.g. peak units) or demand resources may be based on a so-called reliability study [2].

### General assumptions

The boundary for both cost and performance data is the generation assets plus the infrastructure required to deliver the energy to the main grid. For electricity, this is the nearest land-based substation of the transmission/distribution grid. In other words, the technologies are described as they are perceived by the electricity system receiving their energy deliveries.

In the calculation and description of technology cost and performance, it is assumed that a typical service is characterized by 200 operating hours, 75% are taking place at full load, while the remaining is characterized by part-load generation.

Due to service envisioned and the low number of operating hours, no investment in environmental facilities to reduce polluting emissions is assumed in this catalogue. Indeed, European directives and relative national Danish implementations exempts plants operating for less than 500 hours a year from complying with the emission limitations. The assumption of no deployment of environmental facilities is therefore valid for all operations below this threshold of 500 hours a year.

More detail on environmental aspects and legislation is available in ANNEX 2: Emissions limitations for peak- and reserve plants.

Co-generation of district heating is not considered for these technologies. Indeed, with 200 operating hours, it is assumed that investments in facilities to collect the heat will not be economically justified<sup>25</sup>. Moreover, the access to district heating network poses limits to the choice of the location of the emergency plant in the power network.

### O&M and Start-up costs

In expressing the operations and maintenance cost for the reserve and peakers technologies in this chapter, the same approach of the main catalogue is used: O&M costs stated in this catalogue includes start-up costs and takes into account a typical number of start-ups and shut-downs. Therefore, the start-up costs specified in the data sheet should not be specifically included in more general analyses. They should only be used in detailed dynamic analyses of the hour-by-hour load of the technology. For all three peaking technologies 50 start-ups a year is assumed to be representative.

Maintenance on engines and OCGT turbines is generally done according to a maintenance schedule that is based on a certain number of total running hours. This means that a plant with very few annual operating hours will have a low variable cost until it reaches one of the bigger schedules. With the 200 hours a year assumed, the large maintenance window will not be reached in the lifetime of the plant, reducing maintenance costs and scheduled downtime, compared

---

<sup>25</sup> As a reference, the extra investment cost of adding district heating equipment to an engine for cogeneration purposes is around 50-100 €/kW.

to a plant with fuller load hours a year. Another driver for a lower O&M cost compared to a baseload or intermediate plant is the possibility to monitor and operate the plant remotely, removing the need for permanent staff on site.

**Technologies assessed and qualitative comparison**

The technologies considered to provide peak and reserve service diesel engines, natural gas engines and open cycle gas turbines.

Figure 3 shows a qualitative comparison of the technologies presented in this chapter across the main parameter. It has to be noted that this is an indicative ranking based on the central estimate values and it can vary depending on specific applications.

|         | CAPEX                    | OPEX                     | Efficiency               | Emissions                | Dynamic performance      |
|---------|--------------------------|--------------------------|--------------------------|--------------------------|--------------------------|
| Best ↑  | Diesel engine farm       | Natural gas engine plant | Natural gas engine plant | Natural gas engine plant | Diesel engine farm       |
|         | Open Cycle Gas Turbine   | Open Cycle Gas Turbine   | Open Cycle Gas Turbine   | Open Cycle Gas Turbine   | Natural gas engine plant |
| ↓ Worst | Natural gas engine plant | Diesel engine farm       | Diesel engine farm       | Diesel engine farm       | Open Cycle Gas Turbine   |

Figure 3 Qualitative comparison of technologies described in the chapter, across the five main parameters.

*Diesel engine farms* present the lowest level of CAPEX and good dynamic performance, with short start-up time and flexible operation. On the other hand, they perform less well on efficiency, operational costs and emissions. *Natural gas engine* plants have high efficiencies even at lower loads, low emissions and operational costs, good dynamic performance, but are the most expensive solution. Finally, *Open cycle gas turbines* presents a medium level of capital and operational costs, have the worst dynamic performance, especially in terms of start-up time and ramp rates and features a reduced efficiency and increased emissions at part load.

**Forecasting future costs**

Historic data shows that the cost of most electricity production technologies has been reduced over time. It can be expected that further cost reductions and improvements of performance will also be realized in the future. Such trends are important to consider for future energy planning and therefore need to be taken into account in the technology catalogue.<sup>26</sup>

For projection of future financial costs there are three overall approaches: Engineering bottom-up, Delphi-survey, and Learning curves. This catalogue uses the learning curve approach. The reason is, that this method has proved historically robust and that it is possible to estimate learning rates for most technologies. Furthermore, learning curve correlations are well documented, the risk of bias is reduced compared to the alternative approaches. The cost projections are based on the future generation capacity in IEA’s 2 DS and 4 DS scenarios (2017 values are assumed to be a good approximation for 2015) [3].

Learning rates typically vary between 5 and 25%. In 2015, Rubin et al published “A review of learning rates for electricity supply technologies” [4], which provides a comprehensive and up to date overview of learning rates for a range of relevant technologies, among which:

<sup>26</sup> Based on methodology developed and explained in “Technology Data for the Indonesian Power Sector” [6].

Table 1 Learning rates from different technologies [4].

| Technology               | Mean learning rate | Range of studies |
|--------------------------|--------------------|------------------|
| Coal                     | 8.3%               | 5.6 to 12%       |
| Natural gas CC           | 14%                | -11 to 34%       |
| Natural gas, gas turbine | 15%                | 10 to 22%        |
| Nuclear                  | -                  | Negative to 6%   |
| Biomass power            | 11%                | 0 to 24%         |

The authors of the review emphasize that “methods, data, and assumptions adopted by researchers to characterize historical learning rates of power plant technologies vary widely, resulting in high variability across studies. Nor are historical trends a guarantee of future behaviour, especially when future conditions may differ significantly from those of the past” [4]. Still, the study gives an indication of the level of learning rates, which may be expected. 10-15% seems to be a common level for many technologies, whereas nuclear power and coal are in the lower end.

Considering the uncertainties related to the estimation of learning rates, a default learning rate of 10% is applied for the technologies in this catalogue. The choice of the lower bound reflects the fact that all technologies treated in the catalogue are all mature technologies corresponding to Category 4.

When the abovementioned learning rates are combined with the future deployment of the technologies projected in the IEA scenarios, an estimate of the cost development over time can be deduced.

Table 2 Estimated development of technology costs in the IEA’s 2 and 4 DS scenarios in 2020, 2030 and 2050, relative to 2017. The average of 2DS and 4DS is considered in this catalogue.

| Technology  | Rate | 2DS  |      |      |      | 4 DS |      |      |      | Average of 2 & 4 DS |      |      |      |
|-------------|------|------|------|------|------|------|------|------|------|---------------------|------|------|------|
|             |      | 2017 | 2020 | 2030 | 2050 | 2017 | 2020 | 2030 | 2050 | 2017                | 2020 | 2030 | 2050 |
| Oil         | 10%  | 100% | 98%  | 98%  | 97%  | 100% | 98%  | 98%  | 94%  | 100%                | 98%  | 98%  | 96%  |
| Natural gas | 10%  | 100% | 97%  | 94%  | 91%  | 100% | 97%  | 92%  | 85%  | 100%                | 97%  | 93%  | 88%  |



## References

- [1] Energinet.dk, “Energi Data Service,” 2017. [Online]. Available: <https://www.energidataservice.dk/en/>. [Accessed: 02-Aug-2018].
- [2] EUETS.com, “Strategic reserve as a capacity remuneration mechanism (CRM).” [Online]. Available: [www.emissions-euets.com/strategic-reserve](http://www.emissions-euets.com/strategic-reserve).
- [3] IEA, “Energy Technology Perspectives 2016,” 2016.
- [4] E. S. Rubin, I. M. L. Azevedo, P. Jaramillo, and S. Yeh, “A review of learning rates for electricity supply technologies,” *Energy Policy*, vol. 86, pp. 198–218, Nov. 2015.
- [5] D. Santoianni, “Defining true flexibility – a comparison of gas-fired power generating technologies,” *Detail Wärtsilä Tech. J.*, vol. 1, pp. 10–15, 2015.
- [6] T. Data and P. Plants, “Technology Data for the Indonesian Power Sector,” no. December, pp. 1–140, 2017.

## 50 Diesel Engine Farm

### Contact information:

Energinet.dk: Rune Grandal, [rdg@energinet.dk](mailto:rdg@energinet.dk)

Danish Energy Agency: Filip Gamborg, [fgb@ens.dk](mailto:fgb@ens.dk)

Author: Ea Energy Analyses

### Publication date

November 2018

### Amendments after publication date

---

| Date | Ref. | Description |
|------|------|-------------|
|      |      |             |

## Qualitative description

### Brief technology description

Diesel farms or gensets are blocks of reciprocating diesel engines which includes an electric generator. They provide modular electric generating capacity and come in standardized sizes. Lately, they have been widely used in the United Kingdom (UK) to provide standby power generation for large industrial and commercial sites that cannot afford to lose power in the event of interruptions of the electricity network supply.

Increasingly, they are being built and connected to the network also to provide peak clipping to avoid demand charges. They are able to start-up and reach full load very quickly, which is very useful to National Grid in managing short-term fluctuations and potentially other ancillary services. A typical diesel farm is constituted by a set of containerized diesel engines of various ratings (normally from 400-500 kW up to the MW scale) and a connection to the grid by means of low to medium voltage transformer.

The deployment of this solution for peaking and reserve service has been relevant in United Kingdom following the auctions for capacity market implemented starting from 2014 and those for Short term operating reserve (STOR). One of the reasons for the success of these type of plants is the access to several nested benefits. First of all, they could receive a payment from the capacity market for the availability of their capacity; moreover, they could partially participate to the auctions for STOR.

Additionally, they have access to the so called “embedded benefits”, exempting them to pay the connection charges in light of the fact that they are connected to the distribution grid. Finally, until November 2015, they could access the Enterprise Investment Scheme (EIS) designed to help smaller, higher-risk trading companies raise finance by offering a range of tax reliefs.

Following an internal debate, a reform of embedded benefits is expected in the near future. After the publication of a note stating that this reform could be applied retroactively to new plants once it will enter into force, a large number of proposed diesel farms have been retired from the last round of capacity market auction in December 2017, questioning the future for this solution in UK.

### Input

The input is light fuel oil (diesel or biodiesel).

### Output

The output is electricity.

### Typical capacities

In the latest tender for capacity market and short term operating reserve in the UK, the typical farm size was between 3 MW and 50 MW. However, given the modularity of the solution, it is potentially expandable to higher ratings. A very large number of plants awarded are around 18 – 20 MW, constituted by a variable number of engines rated 400 kW – 2 MW each. This is assumed as the typical capacity of the plant.

### Regulation ability and other power system services

The start-up time of diesel generators are amongst the lowest compared to other generation facilities.

A typical figure for the cold start-up time of these types of generators is down to 2-3 minutes. The ramping capabilities are also good, with a typical engine able to provide 50% output in around 15 seconds and full capacity after 5 additional seconds. Part load generation does not result in a large drop of efficiency due to the modular nature of the diesel farm. When the plant has to be regulated downward, some generators can be switched off and each online generator can be kept at the optimal output level (for emissions and efficiency).

### Advantages/disadvantages

Advantages and disadvantages of this technology is stated in relation to other peak and reserve options.

#### *Advantages*

- Known and proven technology with high reliability
- Minimal impact of ambient conditions (temperature and altitude) on plant performance and functionality
- Very low CAPEX
- High performance and low response time
- High efficiency at part load
- Decentralized option
- Modular solution
- Short construction time
- Option to use biodiesel

#### *Disadvantages*

- High air pollutant emissions
- Need for on-site tanks to store diesel
- Relatively low efficiency
- Expensive fuel

### Environment

Emissions highly depend on the characteristics of the fuel applied, fuel type and its content of sulphur.

Diesel generators are one of the most polluting sources of electricity. Beside large CO<sub>2</sub> emissions, other pollutants include Nox, SO<sub>2</sub> and particles. The fact that the engines are assumed to run on average for less than 500 hours a year, makes them eligible for exemption to emission limitation by EU directive on medium combustion plants. This results in higher specific emission whenever they are running.

### Research and development perspective

Diesel generators have reached technological maturity long ago and, while some developments are still happening in the emission reduction and dynamic performance, the engines used for the services described in this catalogue will most likely not be Best-available-technology, due to the need to keep CAPEX levels low.

### Example of market standard technology

Example of market standard diesel farms for the provision of reserve and peak load are represented by the plants built in United Kingdom in the last few years following auctions for capacity market and reserve services. In order to access different revenue streams and participate to e.g. frequency regulation, most of these plants have start-up time as low as 2-3 minutes.



Figure 1 A diesel farm in the Ernesettle area of Plymouth. Photograph: Ben Mostyn for the Guardian.

Figure 1 shows a 20 MW diesel farm built close to Plymouth (UK) and composed of 52 containerized diesel generators, for the provision of STOR service. Smaller 400 kW units have been used.



**Figure 2** Emergency plant in Cornwall. Photograph: SEA Trasformatori

Figure 2 shows a similar plant of 20 MW plant built as an emergency reserve in Cornwall (UK), composed of 40 diesel generators and 10 step-up transformers.

### Prediction of performance and cost

The technology is classified under the Category 4: Commercial, limited development potential.

Due to technological maturity, a progressive switch to less polluting power sources and the problems of public acceptance, no significant reduction in investment and operation costs are expected in the future.

Some technical improvements can be expected from the manufacturers driven mainly by other applications such as marine propulsion.

### Uncertainty

The uncertainty in the quantitative figures mainly relates to the different manufacturers using different models and makes of engines making up the diesel farm.

### Additional remarks

The proposal of excluding all plants with specific CO<sub>2</sub> emissions above 550g/kWh from capacity mechanisms payments poses a regulatory risk on future installation of this technology (see ANNEX 2: Emissions limitations for peak- and reserve plants for details).

## Data sheet

| Technology   | Diesel engine farm |      |      |      |                    |       |                    |       |      |         |
|--|--------------------|------|------|------|--------------------|-------|--------------------|-------|------|---------|
|  | 2015               | 2020 | 2030 | 2050 | Uncertainty (2020) |       | Uncertainty (2050) |       | Note | Ref     |
| Energy/technical data                              |                    |      |      |      | Lower              | Upper | Lower              | Upper |      |         |
| Generating capacity for one unit (MW)              | 18                 |      |      |      |                    |       |                    |       | A, B |         |
| Electricity efficiency, net (%), name plate        | 37                 | 37   | 37   | 37   | 35                 | 39    |                    |       |      | 1, 2, 3 |
| Electricity efficiency, net (%), annual average    | 35                 | 35   | 35   | 35   | 33                 | 37    |                    |       | C    |         |
| Cb coefficient (50°C/100°C)                        | -                  | -    | -    | -    |                    |       |                    |       |      |         |
| Cv coefficient (50°C/100°C)                        | -                  | -    | -    | -    |                    |       |                    |       |      |         |
| Forced outage (%)                                  | 90                 | 90   | 90   | 90   |                    |       |                    |       |      | 4       |
| Planned outage (days per year)                     | 1.2                | 1.2  | 1.2  | 1.2  |                    |       |                    |       | D, E | 5       |
| Technical lifetime (years)                         | 25                 | 25   | 25   | 25   |                    |       |                    |       |      |         |
| Construction time (years)                          | 1                  | 1    | 1    | 1    |                    |       |                    |       |      | 6       |
| <b>Regulation ability</b>                          |                    |      |      |      |                    |       |                    |       |      |         |
| Primary regulation (% of full load per 30 seconds) | 100                | 100  | 100  | 100  |                    |       |                    |       | F    | 6       |
| Secondary regulation (% of full load per minute)   | 100                | 100  | 100  | 100  |                    |       |                    |       | F    | 6       |
| Minimum load (% of full load)                      | 1                  | 1    | 1    | 1    |                    |       |                    |       | G    |         |
| Warm start-up time (minutes)                       | 1                  | 1    | 1    | 1    | 0.5                | 2     |                    |       | H    | 6, 7    |
| Cold start-up time (minutes)                       | 5                  | 5    | 5    | 5    | 3                  | 10    |                    |       | H    | 6       |
| <b>Environment</b>                                 |                    |      |      |      |                    |       |                    |       |      |         |
| SO <sub>2</sub> (g per GJ fuel)                    | 23                 | 23   | 23   | 23   |                    |       |                    |       | I    | 8       |
| NO <sub>x</sub> (g per GJ fuel)                    | 942                | 942  | 942  | 942  |                    |       |                    |       |      | 8       |

|                             |       |       |       |       |       |       |       |       |         |             |
|-----------------------------|-------|-------|-------|-------|-------|-------|-------|-------|---------|-------------|
| CH4 (g per GJ fuel)         | 24    | 24    | 24    | 24    |       |       |       |       |         | 8           |
| N2O (g per GJ fuel)         | 2.1   | 2.1   | 2.1   | 2.1   |       |       |       |       |         | 8           |
| Particles (g per GJ fuel)   | 5.0   | 5.0   | 5.0   | 5.0   |       |       |       |       |         | 8           |
|                             |       |       |       |       |       |       |       |       |         |             |
| <b>Financial data</b>       |       |       |       |       |       |       |       |       |         |             |
| Specific investment (M€/MW) | 0.350 | 0.343 | 0.343 | 0.336 | 0.274 | 0.412 | 0.235 | 0.437 | M, N, O | 1, 6, 9, 10 |
| - of which equipment        | 0.228 | 0.223 | 0.223 | 0.218 |       |       |       |       | L       |             |
| - of which installation     | 0.123 | 0.120 | 0.120 | 0.118 |       |       |       |       | L       |             |
| Fixed O&M (€/MW/year)       | 8,800 | 8,800 | 8,448 | 8,096 |       |       |       |       | D, P, Q | 6           |
| Variable O&M (€/MWh)        | 6     | 6     | 6     | 6     | 2.6   | 8.5   | 2.6   | 8.5   |         | 11,12,13    |
| Startup cost (€/MW/startup) | -     | -     | -     | -     |       |       |       |       | R       | 6, 11       |

### Notes

- A The range of generating capacity for a plant based on this technology is typically 10-300 MW. Most of UK projects are in the range 18.5-20 MW. Emission requirements for plants with 18.5 MW and above are regulated by the Danish EPA and it is as of yet undetermined whether and exemption due to low operating hours can be obtained.
- B Engine size is normally in the range 400 kW – 2 MW. Here considered 10 engines of 1.8 MW.
- C Assuming the same efficiency reduction from nameplate to annual average compared to Gas Engines in the main technology catalogue.
- D The routine checks and oil change varies depending on the size. Smaller engines (400 kW) needs it every 250 h, while larger engines (2 MW) needs it every 1000h. Here assumed larger engines. Fixed O&M costs can increase for smaller sizes.
- E 1.5h monthly maintenance for general checks, 4h semiannual, 2h annually, 2h biannually, 6h every 6 years.
- F 50% of the output capacity can be reach within 15 seconds and after 20 seconds the total power output can be provided.
- G Minimum load of the single engine is 30%. In a modular solution, some engines can be switched off to reduce the minimum load of the total plant. This way the performance is maintained at the optimal level.
- H The startup time of the single engine is around 30 seconds. The yncronization of all the machines and the connection to the grid might increase the startup time to 3-10 minutes.
- I Values related to the use of gas oil.
- J Split based on the Engine technology in the main technology catalogue
- K Development of cost follows the assumptions explained in the introduction. 10% learning rate and capacity development based on IEA ETP 2016.
- L The specific investment cost can vary depending on a number of parameters, like size of engines, electrical equipment and other engines characteristics. The specific investment in 2015 from several projects and sources is in the range 0.282-0.456 M€/MW.

- M The uncertainty is estimated based on the cost span of a number of similar observed projects. It is assumed equal to  $\pm 20\%$  in 2020 and it increases to  $\pm 30\%$  in 2050.
- N Assumed a reduction of 4% in 2030 and 8% in 2050, due to automation of the power plant control and improvement in the operation
- O Assumed two times the reported value for service agreement excluding consumables, to take into account other fixed O&M components.
- P The maintenance schedule is not affected by frequent starts and stops, fuel, or trips as modern combustion engines have the capability to stop and start without limitations or maintenance impact.

### References

- [1] Interview with Rolls Royce Power Systems
- [2] C. Breyer. *Fuel-Parity: New very large and sustainable market segments for PV systems*. 2010
- [3] National Grid. *Short Term Operating Reserve – Carbon intensity report*. 2016
- [4] EEA. *Distributed Generation Operational Reliability and Availability Database*. 2004
- [5] Maintenance schedule Caterpillar Emergency generator. Available at: [https://ae.usembassy.gov/wp-content/uploads/sites/254/2017/06/stc12017q0002\\_post-provided-generator-checklist.pdf](https://ae.usembassy.gov/wp-content/uploads/sites/254/2017/06/stc12017q0002_post-provided-generator-checklist.pdf)
- [6] Interview with UK manufacturer: Edina Power UK
- [7] Warstsila. *White paper – Combustion engine power plants*. 2011
- [8] Institut for Miljøvidenskab. Emission factors. Available at: <http://envs.au.dk/videnudveksling/luft/emissioner/emission-factors/>
- [9] Timera Energy. *Investment in UK peaking assets*. Available at: [www.timera-energy.com/investment-in-uk-peaking-assets](http://www.timera-energy.com/investment-in-uk-peaking-assets)
- [10] UK Department for Business, Energy and Industrial Strategy. *Electricity Generation Cost*. November 2016
- [11] EUGINE (European Engine Power Plants Association) questionnaire to their members. Data presented in “*Flexibility Needs and Options for Europe’s Future Electricity System*”, Energy Brainpool, September 2017.
- [12] BEIS. *Electricity Generation cost*. November 2016
- [13] LAZARD. *Levelized cost of energy analysis v11*. November 2017



## 51 Natural Gas Engine Plant

### Contact information:

Energinet.dk: Rune Grandal, [rdg@energinet.dk](mailto:rdg@energinet.dk)

Danish Energy Agency: Filip Gamborg, [fgb@ens.dk](mailto:fgb@ens.dk)

Author: Ea Energy Analyses

### Publication date

November 2018

### Amendments after publication date

| Date | Ref. | Description |
|------|------|-------------|
|      |      |             |

## Qualitative description

### Brief technology description

The description of the natural gas engine technology is presented in the main catalogue. The only difference in the technology used for the service presented here is the lack of district heating connection. Several large engines, which size can vary between 1 and 10 MW, can be combined into a power plant, as shown in Figure 1.

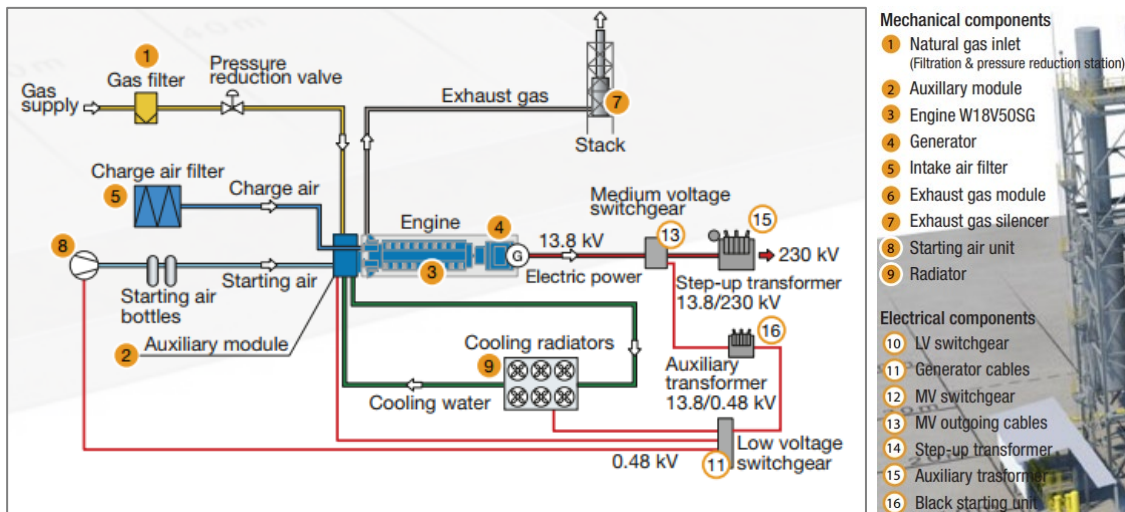

Figure 1 Large engine power plant scheme [16].

The gas engines can be upgraded to handle dual fuel operation, utilizing light fuel oil and natural gas with the capability to switch fuel supply while operating. This increases the reliability of the system at the expense of slightly higher engine cost and the installation of fuel storage tanks on-site.

Increasing need for flexibility and backup following the increasing variable renewable sources penetration, combined with stringent regulations related to emissions of pollutants and CO<sub>2</sub>, is expected to lead to the utilization of natural gas plant for emergency and reserve services.

### Input

The input is Natural gas with the option to have dual fuel operation with Light Fuel Oil (LFO).

In the future, biogas and biodiesel could be considered as alternative, with low impact on the cost and a slight reduction of efficiency.

### Output

The output is electricity.

### Typical capacities

Typical capacities for these plants range from 20 MW to 400 MW. The technology is modular and easily scalable.

### Regulation ability and other power system services

The response time of gas engines is very low, with new models able to start in one or two minutes.

However, for large plants used in emergency situations and connected to high voltage grid, the temperature of the transformer becomes the largest bottleneck related to ramp-up production. This increases the cold start-up time to 10 minutes.

The reduction of efficiency at part load is much lower compared to open-cycle gas turbines and equal to about 4%-point reduction from full-load efficiency to 30% part-load efficiency.

When running, the ramp rates of engine power plants are very high, corresponding to more than 100% of load per min.

The dynamic characteristics of a gas engine power plant are depicted in Figure 2.

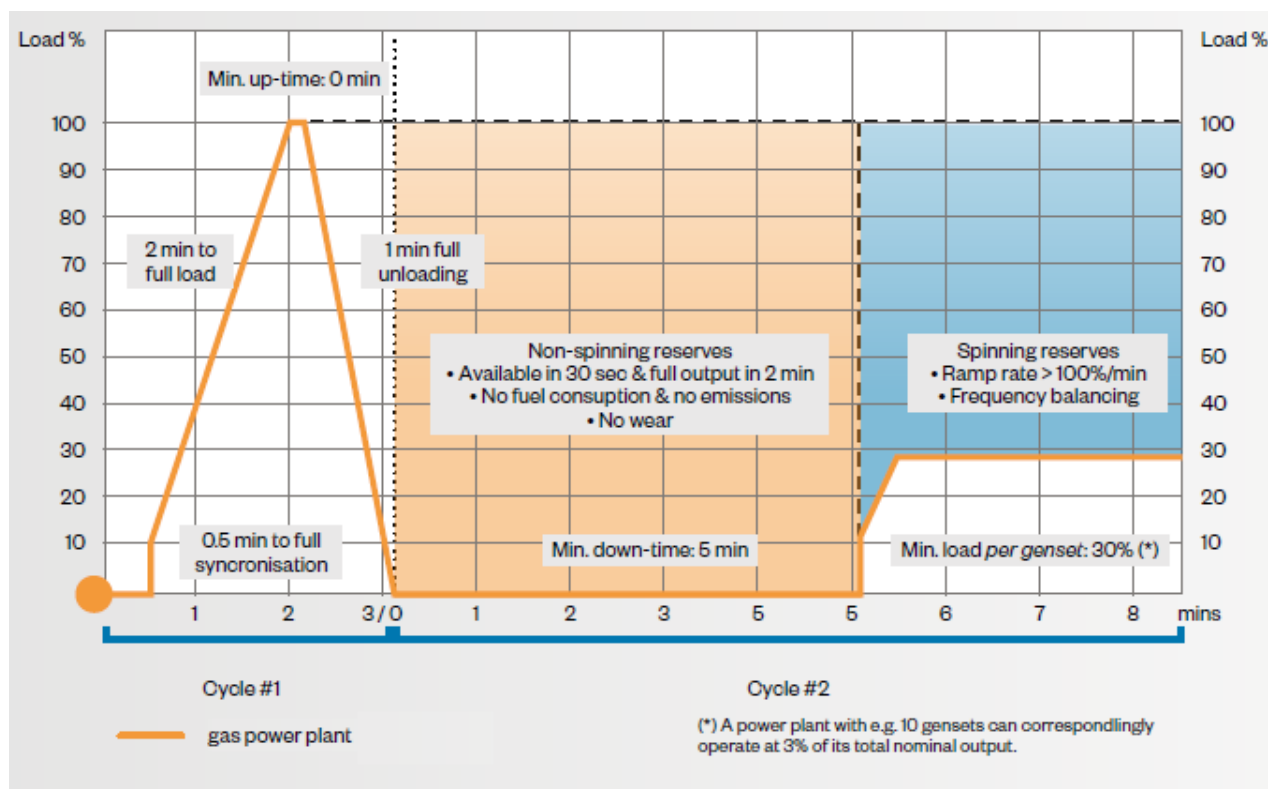

Figure 2 Dynamic characteristic of a gas engine power plant [13].

### Advantages/disadvantages

Advantages and disadvantages of this technology is stated in relation to other peak and reserve options.

#### Advantages

- Known and proven technology with high reliability
- High efficiency
- Modular solution
- High performance and ramp rate and low response time
- Low emission, also at part-load
- Relatively low fixed OPEX
- Possibility of dual fuel operation

#### Disadvantages

- More expensive than diesel and OCGT solution
- Larger space requirements and installation time than OCGT
- Necessity of connection to the gas grid, with related investment and operational costs
- Higher Nox emission than OCGT at full load

### Environment

Gas engines emissions are much lower compared to diesel gensets. Modern gas engine models comply with all industrial emission standards without the need to use catalysts.

A small and inexpensive CO catalyst can be used to limit the CO emissions.

### Research and development perspective

The technology is considered mature with small potential for improvement. Some developments are happening in relation to dynamic performance and emissions. The efficiency will also increase slightly due to improvement of the engine design and is expected to reach a value of 50% by 2030.

### Example of market standard technology

An example of market standard technology is the Kiisa plant commissioned by Wartsila for the Estonian TSO Elering between 2013 and 2014 [14]. It is an emergency and reserve power plant composed by two units (100+150 MW) for a total of 27 engines rated 10 MW each. The engines are dual fuel and can run on natural gas or light fuel oil.

The plant is remotely controlled from the control center in Tallin and requires no personnel on site. The standby consumption is maintained very low at 200 kW using a air heat pump to keep the equipment warm and ready to start service [15].



Figure 3 Kiisa emergency reserve power plant (ERPP) in Estonia [14].

### Prediction of performance and cost

The technology is classified under the Category 4: Commercial, limited development potential.

Some developments can be expected in terms of improved experience in managing the gas engines for reserve purpose and optimization of plant design. However, the impact on cost will be minor.

### Uncertainty

The uncertainty in the quantitative figures mainly relates to the different manufacturers and quality of engines utilized.

## Data sheet

| Technology  | Natural gas engine plant |      |      |      |                    |       |                    |       |      |      |
|---|--------------------------|------|------|------|--------------------|-------|--------------------|-------|------|------|
|   | 2015                     | 2020 | 2030 | 2050 | Uncertainty (2020) |       | Uncertainty (2050) |       | Note | Ref  |
| Energy/technical data   |                          |      |      |      | Low er             | Upper | Low er             | Upper |      |      |
| Generating capacity for one unit (MW)   | 200                      |      |      |      |                    |       |                    |       | A, B |      |
| Electricity efficiency (condensation mode for extraction plants), net (%), name plate     | 48                       | 48   | 50   | 50   |                    |       |                    |       | C    | 1    |
| Electricity efficiency (condensation mode for extraction plants), net (%), annual average | 46                       | 46   | 48   | 48   |                    |       |                    |       | D    | 2    |
| Cb coefficient (50°C/100°C)   | -                        | -    | -    | -    |                    |       |                    |       |      |      |
| Cv coefficient (50°C/100°C)   | -                        | -    | -    | -    |                    |       |                    |       |      |      |
| Forced outage (%)   | 0.9                      | 0.9  | 0.9  | 0.9  |                    |       |                    |       |      | 3    |
| Planned outage (days per year)  | 0.2                      | 0.2  | 0.2  | 0.2  |                    |       |                    |       | E    |      |
| Technical lifetime (years)  | 25                       | 25   | 25   | 25   |                    |       |                    |       | F    |      |
| Construction time (years)   | 1                        | 1    | 1    | 1    |                    |       |                    |       |      | 4, 5 |
| <b>Regulation ability</b>   |                          |      |      |      |                    |       |                    |       |      |      |
| Primary regulation (% of full load per 30 seconds)  | 60                       | 60   | 60   | 60   |                    |       |                    |       | G    | 6    |
| Secondary regulation (% of full load per minute)  | 100                      | 100  | 100  | 100  |                    |       |                    |       | G    | 6    |
| Minimum load (% of full load)   | 1.5                      | 1.5  | 1.5  | 1.5  |                    |       |                    |       | H    | 6, 7 |
| Warm start-up time (minutes)  | 2                        | 2    | 2    | 2    |                    |       |                    |       | I    | 7    |
| Cold start-up time (minutes)  | 10                       | 10   | 10   | 10   |                    |       |                    |       | I    | 7    |
| <b>Environment</b>  |                          |      |      |      |                    |       |                    |       |      |      |
| SO <sub>2</sub> (g per GJ fuel)   | 0                        | 0    | 0    | 0    |                    |       |                    |       | F    | 2    |
| NO <sub>x</sub> (g per GJ fuel)   | 75                       | 75   | 75   | 75   |                    |       |                    |       | F    | 2    |
| CH <sub>4</sub> (g per GJ fuel)   | 315                      | 315  | 315  | 315  |                    |       |                    |       | F    | 2    |

|                             |       |       |       |       |       |       |       |       |            |            |
|-----------------------------|-------|-------|-------|-------|-------|-------|-------|-------|------------|------------|
| N2O (g per GJ fuel)         | 0.6   | 0.6   | 0.6   | 0.6   |       |       |       |       | F          | 2          |
| Particles (g per GJ fuel)   | 0.76  | 0.76  | 0.76  | 0.76  |       |       |       |       |            | 8          |
|                             |       |       |       |       |       |       |       |       |            |            |
| <b>Financial data</b>       |       |       |       |       |       |       |       |       |            |            |
| Specific investment (M€/MW) | 0.510 | 0.495 | 0.474 | 0.449 | 0.396 | 0.594 | 0.314 | 0.583 | L, M, N, R | 7, 5, 9    |
| - of which equipment        | 0.332 | 0.322 | 0.308 | 0.292 |       |       |       |       | F          | 2          |
| - of which installation     | 0.179 | 0.173 | 0.166 | 0.157 |       |       |       |       | F          | 2          |
| Fixed O&M (€/MW/year)       | 6,500 | 6,500 | 6,250 | 6,000 |       |       |       |       | O, P       | 7          |
| Variable O&M (€/MWh)        | 6     | 6     | 6     | 6     | 2.6   | 8.5   | 2.6   | 8.5   |            | 10, 11, 12 |
| Startup cost (€/MW/startup) | 0     | 0     | 0     | 0     |       |       |       |       | Q          | 10         |

## Notes

- A The technology is modular, normally composed by a certain amount of 2-10 MW engines. Here 20 engines of 10 MW are considered.
- B Typical capacity for ultra peakers and emergency plants is in the range 20-300 MW
- C Based on large gas motor (Wartsila 34SG)
- D Assuming the same efficiency reduction from nameplate to annual average compared to main technology catalogue.
- E Based on maintenance schedule of gas engines, considering the reduced number of operating hours and the fact that a typical scheduled maintenance services occurs after 2000, 4000 and 6000 hours, with 1 or 2 days of downtime each. No major maintenance window (16,000 h) is reached.
- F Based on the Gas Engine in the main technology catalogue
- G The values refers to the engine at nominal operating temperature.
- H Minimum load of the single engine is 30%. In a modular solution, some engines can be switched off to reduce the minimum load of the total plant. This way the performance is maintained at the optimal level. Calculation done assuming 20x10MW engines.
- I The engines can startup from warm in 2 minutes. The plant cold startup time is affected by the need to warm up the transformers, which brings it up to 10 minutes. If engines and transformers are hot, the startup time is lower. In case of smaller plants connected to distribution grid, the time to warm up the transformer might not constitute a bottleneck.
- J Dual fuel operation can be considered. Impacting 3-4% of the total plant cost and 7% of engine cost
- K Development of cost follows the assumptions explained in the introduction. 10% learning rate and capacity development based on IEA ETP 2016.
- L The specific investment cost can vary depending on a number of parameters, like size of engines, electrical equipment and other engines characteristics. The specific investment in 2015 from several projects and sources is in the range 0.443-0.616 M€/MW. The lower bound refers to smaller plants with smaller engines, while the higher bound refers to dual fuel plant, located further away from the grid.

- M The fixed O&M cost is lower than a typical value for plants operating >4000 h a year. A typical large maintenance window including reinvestment is carried after 10,000 running hours. Due to the low utilization, this type of plants might never need it in its lifetime, reducing the fixed O&M cost drastically. Additionally the central and lower estimates assume unmanned/remote operation of the plant, whereas the upper boundary assumes manned operation.
- N Assumed a reduction of 4% in 2030 and 8% in 2050, due to automation of the power plant control and improvement in the operation
- O The maintenance schedule is not affected by frequent starts and stops, fuel, or trips as modern combustion engines have the capability to stop and start without limitations or maintenance impact. Modern technology can sustain up to 1000 cycles/years with no significant wear.
- P The uncertainty is estimated based on the cost span of a number of similar observed projects. It is assumed equal to  $\pm 20\%$  in 2020 and it increases to  $\pm 30\%$  in 2050.

### References

- 1 Wartsila. *Power Plant solutions 2016*
- 2 Main technology catalogue: *Technology Data for Energy Plants – August 2016*
- 3 EEA. *Distributed Generation Operational Reliability and Availability Database*. 2004
- 4 Kiisa Power plant project for Elering
- 5 Warstsila. *White paper – Combustion engine power plants*. 2011
- 6 D. Santoianni. *Defining true flexibility – a comparison of gas-fired power generating technologies*. 2015
- 7 Phone interview with Wartsila
- 8 Institut for Miljøvidenskab. Emission factors. Available at: <http://envs.au.dk/videnudveksling/luft/emissioner/emission-factors/>
- 9 UK Department for Business, Energy and Industrial Strategy. *Electricity Generation Cost*. November 2016
- 10 EUGINE (European Engine Power Plants Association) questionnaire to their members. Data presented in “Flexibility Needs and Options for Europe’s Future Electricity System”, Energy Brainpool, September 2017.
- 11 BEIS. *Electricity Generation cost*. November 2016
- 12 LAZARD. *Levelized cost of energy analysis v11*. November 2017
- 13 D. Santoianni, “Defining true flexibility – a comparison of gas-fired power generating technologies,” Detail Wärtsilä Tech. J., vol. 1, pp. 10–15, 2015.
- 14 Wartsila, “Kiisa ERPP I & II.” [Online]. Available: <https://www.wartsila.com/energy/references/urope/kiisa-erpp-i-ii>. [Accessed: 08-Feb-2018].



- 15 T. Mahlanen, "Elering Emergency Reserve Power Plant located in Kiisa," 2011
- 16 Wärtsilä Corporation, "Wärtsilä Power Plants Solutions 2016," 2016.

## 52 Open Cycle Gas Turbine

### Contact information:

Energinet.dk: Rune Grandal, [rdg@energinet.dk](mailto:rdg@energinet.dk)

Danish Energy Agency: Filip Gamborg, [fgb@ens.dk](mailto:fgb@ens.dk)

Author: Ea Energy Analyses

### Publication date

November 2018

### Amendments after publication date

| Date | Ref. | Description |
|------|------|-------------|
|      |      |             |

## Qualitative description

### Brief technology description

Open cycle gas turbines (OCGT), also called simple-cycle turbines, are electricity generating units composed of a compressor, combustion chamber, turbine and a coupled generator.

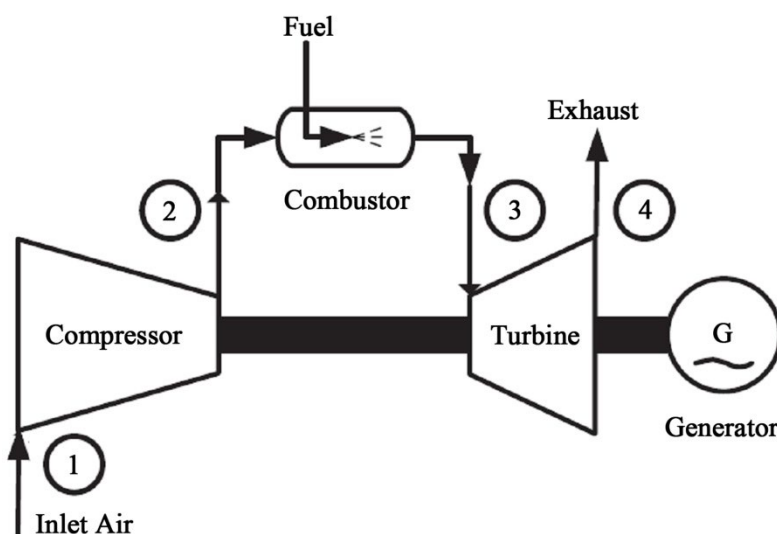

Figure 1 Schematic representation of an Open Cycle Gas Turbine. Figure from: *Scientific Research Open Access*

In power system applications with lower utilization rate and necessity of flexibility, aero-derivative turbines are preferred to heavy industrial ones. Aero-derivative gas turbines are a popular choice for energy generation thanks to their reliability, efficiency and flexibility. Based on advanced aircraft engine technologies and materials, they are significantly lighter, respond faster and have a smaller footprint compared with their heavy industrial GT counterparts. With up to 45% efficiency compared to up to 35% for heavier GTs, these turbines are often seen as a good choice in smaller-scale (up to 100 MW) energy generation [13]. Another feature is their fuel flexibility, allowing a combination of gas and liquid fuel operation.

### Input

The input is natural gas or light fuel oil. Some gas turbines are available in dual-fuel versions (gas/oil).

In the future, biogas and biodiesel could be considered as alternative, with low impact on the performance and cost.

### Output

The output is electricity.

### Typical capacities

Typical capacities of aero-derivative OCGT turbines vary from smaller 5-6 MW turbines to large turbines of 100MW.

For the application described, modular power plant designs composed of smaller turbines are less favourable from an investment cost perspective, since the technology largely benefit from economy of scale. An OCGT-based power plant will therefore most likely be composed by larger aero-derivative turbine (in the range of 50-100 MW) combined for a total output that can reach 200 – 300 MW.

### Regulation ability and other power system services

Modern turbines are able to start-up from cold in just under 10 minutes, with some turbines able to start in 7 minutes. In Figure 2, a typical start sequence is represented. When self-sustained speed is reached, the turbine has a ramp rate capability between 0.17 MW/s and 0.8 MW/s, depending on the model. This corresponds to ramp rates of 15-50 MW/min.

Typical average values are around 20 MW/min, while the largest value corresponds to the 118-MW aero-derivative turbine GE-LMS100.

The part-load characteristic of OCGT is limited by a large drop in efficiency at lower loads. On average, the drop is equal to 15% when going from 100% to 50% load [14].

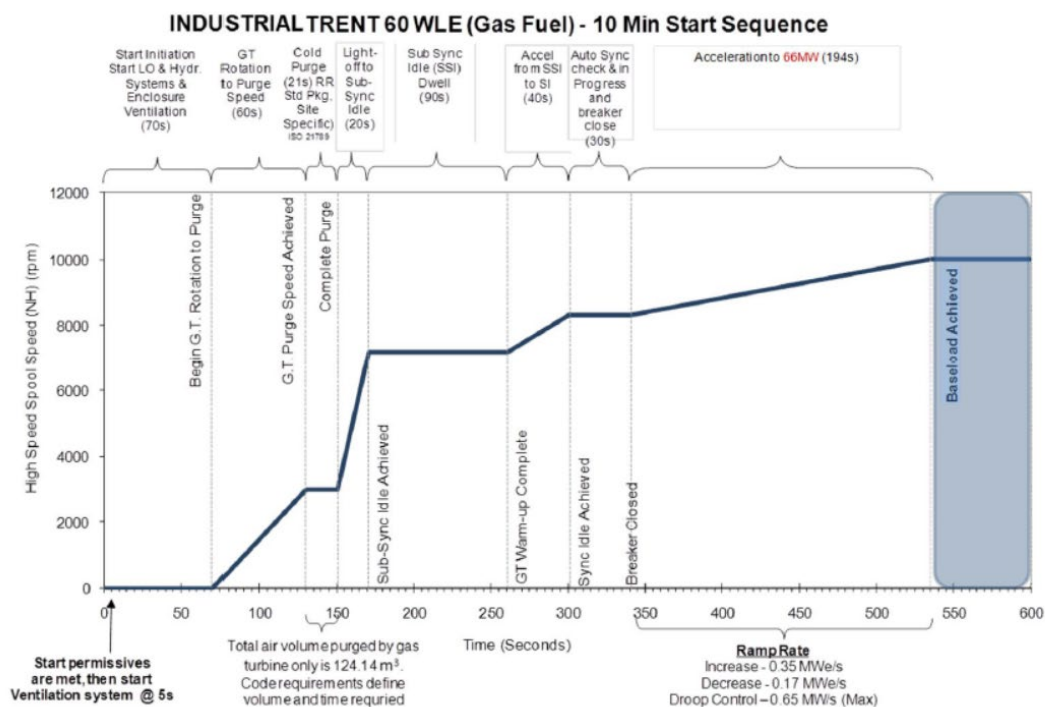

Figure 2 Start sequence and ramp rate of an aero-derivative turbine [15].

### Advantages/disadvantages

Advantages and disadvantages of this technology is stated in relation to other peak and reserve options.

#### Advantages

- Known and proven technology with high reliability
- High performance and low response time
- Higher efficiency than diesel engines at full load
- Short construction time
- Low space requirement
- Low downtime and lower maintenance requirements

#### Disadvantages

- More expensive than diesel solution
- Lower efficiency than gas engines
- Large reduction of efficiency at part-load
- Not ideal for frequent start and stops
- Open cycle gas turbines requires an input of high pressure gas, which limits potential sites available for open cycle gas turbines to locations in close proximity to the gas transmission grid.

### Environment

Gas turbines have continuous combustion with non-cooled walls. This means a very complete combustion and low levels of emissions (other than NO<sub>x</sub>). Developments focusing on the combustors have led to low NO<sub>x</sub> levels [11].

The use of light fuel oil instead of natural gas increases the emissions from the turbine, particularly SO<sub>2</sub>, No<sub>x</sub> and particles.

### Research and development perspective

Increased efficiency for simple-cycle gas turbine configurations has also been reached through inter-cooling and recuperators. Research into humidification (water injection) of intake air processes (HAT) is expected to lead to increased efficiency due to higher mass flow through the turbine.

Additionally, continuous development for less polluting combustion is taking place. Low-NO<sub>x</sub> combustion technology is assumed. Water or steam injection in the burner section may reduce the NO<sub>x</sub> emission, but also the total efficiency and thereby possibly the financial viability. The trend is more towards dry low-NO<sub>x</sub> combustion, which increases the specific cost of the gas turbine [11].

### Example of market standard technology

An example of reserve power plant using OCGT turbines is the Forssa Power Plant, a 318 MW plant commissioned in 2012 for the Finnish TSO Fingrid. It is constituted by two unit of 159 MW each, the fuel used is Light Fuel Oil and the plant is controlled remotely from Fingrid's Main Grid Control Centre in Helsinki. The reported total cost for the plant was 111 million euros<sup>27</sup> [16].

---

<sup>27</sup> Converting the value to 2015€ (from 2010€) and expressing the value in relative terms, this corresponds to an investment cost of 0.39 M€/MW.



Figure 3 Forssa Power plant commissioned for Fingrid [17].

### Prediction of performance and cost

Gas turbine technology is a well-proven commercial technology with numerous power generating installations worldwide, making simple cycle gas turbines a category 4 technology. The cost development will be favoured by an increase in the installation of natural gas generation, mainly to balance the increase in VRES generation worldwide, while the learning rates will be moderate.

### Uncertainty

Uncertainty stated in the tables both covers differences related to the power span covered in the actual table and differences in the various products (manufacturer, quality level, extra equipment, service contract guarantees etc.) on the market.

### Data sheets

Two data sheets are provided for the OCGT: the first is the natural gas fired plant and the second LFO fired one. In the second sheet, only the differences with the first sheet are displayed. All other data can be considered equal to the gas-fuelled plant.

| Technology   | Open cycle gas turbine – natural gas |      |      |      |                    |       |                    |       |      |          |
|--|--------------------------------------|------|------|------|--------------------|-------|--------------------|-------|------|----------|
|  | 2015                                 | 2020 | 2030 | 2050 | Uncertainty (2020) |       | Uncertainty (2050) |       | Note | Ref      |
| Energy/technical data                              |                                      |      |      |      | Lower              | Upper | Lower              | Upper |      |          |
| Generating capacity for one unit (MW)              | 100                                  | 100  | 100  | 100  |                    |       |                    |       | A    |          |
| Electricity efficiency, net (%), name plate        | 41                                   | 42   | 43   | 45   |                    |       |                    |       | B, C | 1, 2     |
| Electricity efficiency, net (%), annual average    | 39                                   | 40   | 41   | 43   |                    |       |                    |       | C    | 3        |
| Cb coefficient (50°C/100°C)                        | -                                    | -    | -    | -    |                    |       |                    |       |      |          |
| Cv coefficient (50°C/100°C)                        | -                                    | -    | -    | -    |                    |       |                    |       |      |          |
| Forced outage (%)                                  | 1.4                                  | 1.4  | 1.4  | 1.4  |                    |       |                    |       |      | 4        |
| Planned outage (days per year)                     | 0.75                                 | 0.75 | 0.75 | 0.75 |                    |       |                    |       | D    | 1        |
| Technical lifetime (years)                         | 25                                   | 25   | 25   | 25   |                    |       |                    |       | E    | 3        |
| Construction time (years)                          | 0.2                                  | 0.2  | 0.2  | 0.2  |                    |       |                    |       | F    | 5        |
|  |                                      |      |      |      |                    |       |                    |       |      |          |
| <b>Regulation ability</b>                          |                                      |      |      |      |                    |       |                    |       |      |          |
| Primary regulation (% of full load per 30 seconds) | 30                                   | 30   | 30   | 30   |                    |       |                    |       | G    | 5        |
| Secondary regulation (% of full load per minute)   | 30                                   | 30   | 30   | 30   | 15                 | 50    |                    |       | H    | 5, 6, 7  |
| Minimum load (% of full load)                      | 25                                   | 20   | 20   | 20   |                    |       |                    |       | I    | 8        |
| Warm start-up time (minutes)                       | 5                                    | 5    | 5    | 5    | 4.5                | 6.5   |                    |       |      | 8, 9, 10 |
| Cold start-up time (minutes)                       | 10                                   | 10   | 10   | 10   | 7                  | 11    |                    |       | L    | 1, 6, 8  |
|  |                                      |      |      |      |                    |       |                    |       |      |          |
| <b>Environment</b>                                 |                                      |      |      |      |                    |       |                    |       |      |          |
| SO <sub>2</sub> (g per GJ fuel)                    | 0.43                                 | 0.43 | 0.43 | 0.43 |                    |       |                    |       |      | 11       |
| NO <sub>x</sub> (g per GJ fuel)                    | 48                                   | 48   | 48   | 48   |                    |       |                    |       |      | 11       |
| CH <sub>4</sub> (g per GJ fuel)                    | 1.7                                  | 1.7  | 1.7  | 1.7  |                    |       |                    |       |      | 11       |
| N <sub>2</sub> O (g per GJ fuel)                   | 1.0                                  | 1.0  | 1.0  | 1.0  |                    |       |                    |       |      | 11       |

|                             |       |       |       |       |       |       |       |       |       |          |
|-----------------------------|-------|-------|-------|-------|-------|-------|-------|-------|-------|----------|
| Particles (g per GJ fuel)   | 0.1   | 0.1   | 0.1   | 0.1   |       |       |       |       |       | 11       |
|                             |       |       |       |       |       |       |       |       |       |          |
| <b>Financial data</b>       |       |       |       |       |       |       |       |       |       |          |
| Specific investment (M€/MW) | 0.468 | 0.454 | 0.435 | 0.412 | 0.363 | 0.545 | 0.288 | 0.535 | M,N,O | 7, 9, 10 |
| - of which equipment        | 0.365 | 0.354 | 0.339 | 0.321 |       |       |       |       |       | 12       |
| - of which installation     | 0.103 | 0.100 | 0.096 | 0.091 |       |       |       |       |       | 12       |
| Fixed O&M (€/MW/year)       | 8,068 | 8,068 | 7,745 | 7,423 |       |       |       |       | P     | 9        |
| Variable O&M (€/MWh)        | 4.5   | 4.5   | 4.5   | 4.5   | 3.5   | 5     | 3.5   | 5     |       | 5, 9, 10 |
| Startup cost (€/MW/startup) | 43    | 43    | 43    | 43    |       |       |       |       |       | 9        |

## Notes

- A The range of generating capacity for a power plant based on this technology is typically 50-200 MW. Large aeroderivative gas turbines have a rating of 20-100 MW.
- B The efficiency is drastically reduced at part-load. The difference between efficiency at full load and part load is on average 15%.
- C Based on the Simple Cycle Turbine in the main technology catalogue. No improvement assumed in the future
- D Considering one service per year for borescope inspection (18h). No major maintenance intervals reached, due to low utilization.
- E Lifetime most likely >25years, given low utilization
- F Some manufacturers' offers pre-assembled mobile packages with installation in 30 days.
- G Based on a droop control of 0.65 MW/s of an Industrial Trent 60 (66MW) turbine at self-sustained speed.
- H Based on a gas turbine at self-sustained speed. Ramp rates of 15 MW/min to 50 MW/min.
- I The minimum emissions-compliant load is around 50%, but in case emission regulations do not apply, this can be lower. The efficiency is reduced at part-load (roughly 15%)
- J The lower bound of 7 minutes might be increased to 10 minutes if the plant is connected to high voltage and transformer needs to warm up before starting operations, similarly to Natural gas engine plants.
- K Development of cost follows the assumptions explained in the introduction. 10% learning rate and capacity development based on IEA ETP 2016.
- L The specific investment cost can vary depending on a number of parameters, like size of turbine, electrical equipment and other characteristics. The specific investment in 2015 from several projects is in the range 0.400-0.570.
- M The uncertainty is estimated based on the cost span of a number of similar observed projects. It is assumed equal to ±20% in 2020 and it increases to ±30% in 2050.
- N Assumed a reduction of 4% in 2030 and 8% in 2050, due to automation of the power plant control and improvement in the operation



| Technology   | Open cycle gas turbine - light fuel oil |      |      |      |                    |       |                    |       |      |     |
|--|---|------|------|------|--------------------|-------|--------------------|-------|------|-----|
|  | 2015                                    | 2020 | 2030 | 2050 | Uncertainty (2020) |       | Uncertainty (2050) |       | Note | Ref |
| Energy/technical data                              |   |      |      |      | Lower              | Upper | Lower              | Upper |      |     |
| Generating capacity for one unit (MW)              |   |      |      |      |                    |       |                    |       |      |     |
| Electricity efficiency, net (%), name plate        | -1                                      | -1   | -1   | -1   | -0.5               | 1     |                    |       | A    | 18  |
| Electricity efficiency, net (%), annual average    | -1                                      | -1   | -1   | -1   | -0.5               | 1     |                    |       | A    | 18  |
| Cb coefficient (50°C/100°C)                        | -                                       | -    | -    | -    |                    |       |                    |       |      |     |
| Cv coefficient (50°C/100°C)                        | -                                       | -    | -    | -    |                    |       |                    |       |      |     |
| Forced outage (%)                                  |   |      |      |      |                    |       |                    |       |      |     |
| Planned outage (days per year)                     |   |      |      |      |                    |       |                    |       |      |     |
| Technical lifetime (years)                         |   |      |      |      |                    |       |                    |       |      |     |
| Construction time (years)                          |   |      |      |      |                    |       |                    |       |      |     |
|  |   |      |      |      |                    |       |                    |       |      |     |
| <b>Regulation ability</b>                          |   |      |      |      |                    |       |                    |       |      |     |
| Primary regulation (% of full load per 30 seconds) |   |      |      |      |                    |       |                    |       |      |     |
| Secondary regulation (% of full load per minute)   |   |      |      |      |                    |       |                    |       |      |     |
| Minimum load (% of full load)                      |   |      |      |      |                    |       |                    |       |      |     |
| Warm start-up time (minutes)                       | +0.5                                    | +0.5 | +0.5 | +0.5 |                    |       |                    |       | A    | 18  |
| Cold start-up time (minutes)                       | +0.5                                    | +0.5 | +0.5 | +0.5 |                    |       |                    |       | A    | 18  |
|  |   |      |      |      |                    |       |                    |       |      |     |
| <b>Environment</b>                                 |   |      |      |      |                    |       |                    |       |      |     |
| SO <sub>2</sub> (g per GJ fuel)                    | 23                                      | 23   | 23   | 23   |                    |       |                    |       | B    | 11  |
| NO <sub>x</sub> (g per GJ fuel)                    | 230                                     | 230  | 230  | 230  |                    |       |                    |       | B    | 11  |
| CH <sub>4</sub> (g per GJ fuel)                    | 3                                       | 3    | 3    | 3    |                    |       |                    |       | B    | 11  |
| N <sub>2</sub> O (g per GJ fuel)                   | 0.6                                     | 0.6  | 0.6  | 0.6  |                    |       |                    |       | B    | 11  |
| Particles (g per GJ fuel)                          | 5.0                                     | 5.0  | 5.0  | 5.0  |                    |       |                    |       | B    | 11  |

|                             |       |       |           |       |       |       |       |       |      |    |
|-----------------------------|-------|-------|-----------|-------|-------|-------|-------|-------|------|----|
|                             |       |       |           |       |       |       |       |       |      |    |
| <b>Financial data</b>       |       |       |           |       |       |       |       |       |      |    |
| Specific investment (M€/MW) | 0.390 | 0.378 | 0.36<br>3 | 0.343 | 0.303 | 0.454 | 0.240 | 0.446 | C, D | 19 |
| - of which equipment        | 0.304 | 0.295 | 0.28<br>3 | 0.268 |       |       |       |       |      | 20 |
| - of which installation     | 0.086 | 0.083 | 0.08<br>0 | 0.076 |       |       |       |       |      | 20 |
| Fixed O&M (€/MW/year)       |       |       |           |       |       |       |       |       |      |    |
| Variable O&M (€/MWh)        |       |       |           |       |       |       |       |       |      |    |
| Startup cost (€/MW/startup) |       |       |           |       |       |       |       |       |      |    |

## Notes

- A Value indicate the estimated change from the correspondent value of natural gas fuelled plant (unit is the same as the paramter).
- B Emission values for Gas Oil. If Residual Oil used, SO<sub>2</sub> emissions increased to 100g, NO<sub>x</sub> reduced to 138g and Particles to 3g.
- C Development of cost follows the assumptions explained in the introduction. 10% learning rate and capacity development based on IEA ETP 2016. Same development as natural gas fuelled plant, since the technology is the same.
- D The uncertainty is estimated based on the cost span of a number of similar observed projects. It is assumed equal to ±20% in 2020 and it increases to ±30% in 2050.

## References

- [1] GE – Aero-derivative turbines product brochures.
- [2] Siemens – Aero-derivative turbine brochures
- [3] Main technology catalogue: Technology Data for Energy Plants – August 2016
- [4] EEA. Distributed Generation Operational Reliability and Availability Database. 2004
- [5] M. Welch, T.Krol. Flexible Power Generation for Grid Support utilizing Aero-derivative Gas Turbine Technology. 2016
- [6] EU Turbines. Gas and Steam Turbines Solutions for a sustainable energy mix (brochure). 2017
- [7] Forssa Power plant for Fingrid. Available at: [www.fingrid.fi/en/pages/news/news/2013/fingrids-new-reserve-power-plant-inaugurated-in-forssa/](http://www.fingrid.fi/en/pages/news/news/2013/fingrids-new-reserve-power-plant-inaugurated-in-forssa/)
- [8] Agora Energiwende. Flexibility in thermal power plants. 2017
- [9] Energy Brainpool. Flexibility Needs and Options for Europe’s Future Electricity System. September 2017.
- [10] Phone interview with Siemens Turbomachinery UK
- [11] Institut for Miljøvidenskab. Emission factors. Available at: <http://envs.au.dk/videnudveksling/luft/emissioner/emission-factors/>
- [12] ESMAP. Technical paper: Study of Equipment Prices in the Power Sector. 2009
- [13] R. Drew, “Flexibility, footprint and reliability advance aero-derivative turbines in a challenging market,” International Turbomachinery, 2017. [Online]. Available: <https://www.turbomachinerymag.com/aero-derivative-gas-turbines/> [Accessed: 08-Feb-2018]
- [14] Energy Brainpool, “Flexibility needs and options for Europe’s future electricity system,” 2017.
- [15] M. Welch and T. Kroll, “Flexible Power Generation for Grid Support utilizing Aero-derivative Gas Turbine Technology.”

- [16] Fingrid, "Fingrid's new reserve power plant inaugurated in Forssa," 2013. [Online]. Available: <https://www.fingrid.fi/en/pages/news/news/2013/fingrids-new-reserve-power-plant-inaugurated-in-forssa/>
- [17] ColGrass, "Forssa Power Plant." [Online]. Available: <http://www.colgrass.it/en/works/forssa-power-plant-finland.html>.
- [18] Phone interview with Siemens Turbomachinery UK
- [19] *Forssa Power plant for Fingrid*. Available at: [www.fingrid.fi/en/pages/news/news/2013/fingrids-new-reserve-power-plant-inaugurated-in-forssa](http://www.fingrid.fi/en/pages/news/news/2013/fingrids-new-reserve-power-plant-inaugurated-in-forssa)
- [20] ESMAP. *Technical paper: Study of Equipment Prices in the Power Sector*. 2009

## ANNEX 1: FEATURES OF STEAM EXTRACTION TURBINES

With an extraction steam turbine, all steam may be condensed (e.g. by sea water) to generate maximum electricity ( $P_C$ ), or all steam may be extracted to be condensed at a higher temperature to generate district heat ( $Q_B$ ). In the latter case, full back-pressure mode (point B in the below figure), some electricity generation is lost ( $P_C - P_B$ ).

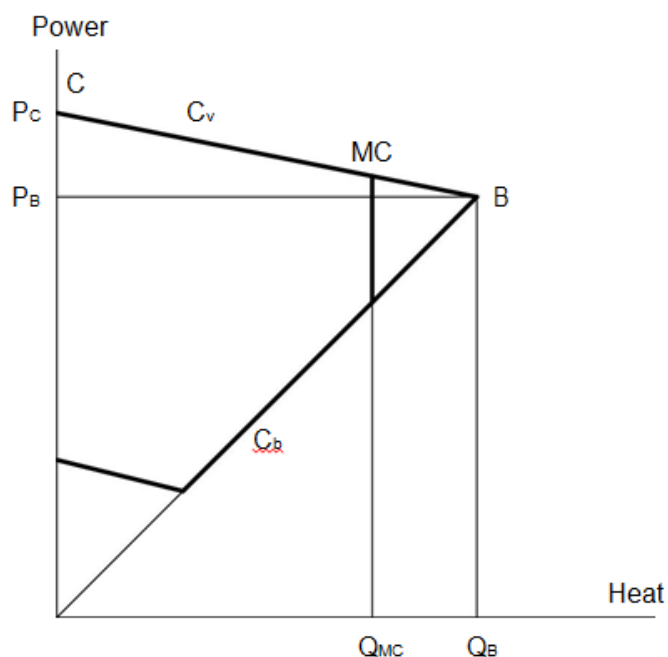

With the steam boiler at full capacity, the turbine may be operated at all points along the line C-B. In the real world, C-B may not be a straight line, but a linear relationship is a good proxy.

By varying full input and steam extraction, the generation of electricity and heat may in theory be varied within the area limited by lines C-B and origo-B. However, in practice there is a minimum power generation capacity (e.g. 10-20% of  $P_C$ ), and the maximum heat generation capacity may be lower than  $Q_B$ .

Below, some relationships are given for key variables.

$P_C$ : Power capacity in full condensation mode; point C. No heat production.

$\eta_{e,c}$ : Electricity efficiency in full condensation mode.

$Q_B$ : Heat capacity in full back-pressure mode (no low-pressure condensation); point B.

$P_B$ : Power capacity in full back-pressure mode.

$Q_{MC}$ : Heat capacity at minimum low-pressure condensation; point MC.

$$\eta_{tot,MC} = \eta_{e,c} \cdot \left\{ 1 + \frac{1 - c_v}{c_b + c_v} \cdot \frac{Q_{MC}}{Q_B} \right\}$$

$c_v$ : Loss of electricity generation per unit of heat generated at fixed fuel input; assumed constant.

$c_b$ : Back-pressure coefficient (electricity divided by heat); assumed constant.

The fuel consumption  $H$  for any given combination of power generation ( $P$ ) and heat generation ( $Q$ ):

$$H = \frac{P + c_v \cdot Q}{\eta_{e,c}}$$

$\eta_{e,B}$ : Electricity efficiency in full back-pressure mode:

$$\eta_{e,B} = \eta_{e,c} \cdot \frac{c_b}{c_b + c_v}$$

$\eta_{q,B}$ : Heat efficiency in full back-pressure mode:

$$\eta_{q,B} = \frac{\eta_{e,c}}{c_b + c_v}$$

$\eta_{tot,B}$ : Total efficiency (electricity plus heat) in full back-pressure mode:

$$\eta_{tot,B} = \eta_{e,c} \cdot \frac{1 + c_b}{c_b + c_v}$$

$\eta_{e,MC}$ : Electricity efficiency at minimum low-pressure condensation:

$$\eta_{e,MC} = \eta_{e,c} \cdot \left\{ 1 - \frac{c_v}{c_b + c_v} \cdot \frac{Q_{MC}}{Q_B} \right\}$$

$\eta_{q,MC}$ : Heat efficiency at minimum low-pressure condensation:

$$\eta_{q,MC} = \frac{\eta_{e,c}}{c_b + c_v} \cdot \frac{Q_{MC}}{Q_B}$$

$\eta_{tot,MC}$ : Total efficiency (electricity plus heat) at minimum low-pressure condensation:

#### Example:

Electricity efficiency in full condensation mode = 45%,  $c_v = 0.15$ ,  $c_b = 1$  and  $Q_{MC}/Q_B = 0.7$ .

This gives the following values in point B:

Electricity efficiency = 39.1%

Heat efficiency = 39.1%

Total efficiency = 78.3%

While in point MC:

Electricity efficiency = 40.9%

Heat efficiency = 27.4%

Total efficiency = 68.3%

## ANNEX 2: Emissions limitations for peak- and reserve plants

The emissions of thermal power plants are regulated at European level, through a number of Directives from the European Union and the subsequent national legislative implementation.

The two main directives to target emission from industrial combustion plants are:

- *Medium Combustion Plant (MCP) Directive*<sup>28</sup>, which covers smaller plants;
- *Industrial Emission Directive (IED)* for larger plants.

Directive (EU) 2015/2193 of the European Parliament and the Council of 25 November 2015 on the limitation of emissions of certain pollutants into the air from medium combustion plants ([Medium Combustion Plant Directive](#)) regulates pollutant emissions from the combustion of fuels in plants with a rated thermal input equal to or greater than 1 megawatt (MWth) and less than 50 MWth. The directive regulates emissions of SO<sub>2</sub>, NO<sub>x</sub> and dust into the air with the aim of reducing those emissions and the risks to human health and the environment they may cause. It also lays down rules to monitor emissions of carbon monoxide (CO).

The emission limit values set in the MCP Directive will have to be applied from 20 December 2018 for newly built plants.

The directive includes the possibility to introduce exemptions from compliance, as a decision of each Member State:

*“Member States may exempt existing medium combustion plants which do not operate more than 500 operating hours per year, as a rolling average over a period of five years, from compliance with the emission limit values”*

The Danish implementation (*MCP-bekendtgørelsen*<sup>29</sup>) sets emission levels for medium size combustion plants (1-50 MWth) in accordance with both EU directives, and the implemented Danish requirements for NO<sub>x</sub>, which are stricter than the directive. Refer to appendices in the Danish directive for current emission limitations. New power plants<sup>30</sup> are subject to regulation, including new peakers. For exceptions see §3. A relevant exception to the regulation is new reserve plants operating less than 500 hours per year on a 3-year rolling average. Such plants do not need to follow regulation on SO<sub>2</sub>, NO<sub>x</sub>, dust and CO. However, if running on solid fuel, these plants must stay below dust emissions of 100 mg/Nm<sup>3</sup> at 6% oxygen.

Large plants (>50 MWth) are covered by the EU Industrial Emission Directive (IED, n. 2010/75/EU), which has been adopted in Denmark through the document *Store fyringsanlæg bekendtgørelsen*<sup>31</sup> and it is effectuating limitations on emissions. The Danish directive targets all larger plants and engines besides diesel engines and soda boilers.

Moreover, similarly to the *MCP-bekendtgørelsen*, large plants for emergency situations operating less than 500 hours are also exempted from the emission limits.

Whether a plant is peak or reserve (emergency situations) is determined through the given definitions (§4.20 and §4.23):

---

<sup>28</sup> See more at: <http://ec.europa.eu/environment/industry/stationary/mcp.htm>

<sup>29</sup> Available online at: <https://www.retsinformation.dk/eli/lta/2017/1478>

<sup>30</sup> defined as plants put into operation after 20 December, 2018.

<sup>31</sup> Available online at: <https://www.retsinformation.dk/Forms/R0710.aspx?id=180091>



**Emergency plant:** *Medium-sized combustion plants kept in readiness and only put into operation if the commonly used generation plants fails, or in the event of a failure in the transmission network*<sup>32</sup>.

**Peak load plant:** *Combustion plant which can be quickly started and stopped to supplement the normal supply of district heating and electricity to make up for the fluctuations in district heating or electricity consumption*<sup>33</sup>.

As of this writing, there is no clear definition of whether a plant could provide the reserve and peaker service interchangeably. This will be later addressed in an appendix to the directive by Miljøstyrelsen<sup>34</sup>.

**Proposal for a Regulation of the European Parliament and of the Council on the internal market for electricity (recast), 30.11.2016, COM (2016) 861 final 2016/0379 (COD):**

A proposal to limit the access to capacity mechanisms to technologies with lower CO<sub>2</sub> emissions has been proposed as part of the *Winter Package*. It states:

*“Generation capacity for which a final investment decision has been made after [OP: entry into force] shall only be eligible to participate in a capacity mechanism if its emissions are below 550 gr CO<sub>2</sub>/kWh. Generation capacity emitting 550 gr CO<sub>2</sub>/kWh or more shall not be committed in capacity mechanisms 5 years after the entry into force of this Regulation”*

This would apply to strategic reserve, since it is defined as a capacity mechanism, leaving room only for gas technologies and the very efficient diesel generators. The potential entry into force of this amendment poses a serious regulation risk for new investments in less efficient and more polluting diesel farms.

The discussion related to the acceptance of the proposal is an ongoing debate topic at EU level and has recently been part of the discussions in the EU28 energy ministers summit (18 December 2017).

The ministers also proposed to supplement the 550gr limit with an alternative limit of “700kg of CO<sub>2</sub> per installed kW per year”, which would allow more polluting plants to remain subsidized when running for a limited number of hours per year<sup>35</sup>. This limit corresponds to 1400 operating hours per year for a power plant with an emission factor of 500 gr CO<sub>2</sub>/kWh.

For reference, an overview of CO<sub>2</sub> emissions from the different type of plants and fuels is shown in Figure .

---

<sup>32</sup> “**Nødanlæg:** Mellemløse fyringsanlæg, der holdes i beredskab og kun sættes i drift, hvis det normalt benyttede anlæg havarerer, eller ved udfald af transmissionsnettet”.

<sup>33</sup> “**Spidslastanlæg:** Fyringsanlæg, som ved udsving i fjernvarme- eller elforbruget kan supplere leveringen af fjernvarme eller el fra den normale forsyning, og som hurtigt kan startes og stoppes.”

<sup>34</sup> As for phone communication with Miljøstyrelsen (December 2017).

<sup>35</sup> See: <https://www.euractiv.com/section/electricity/news/brussels-muddies-waters-on-state-aid-for-coal-power>

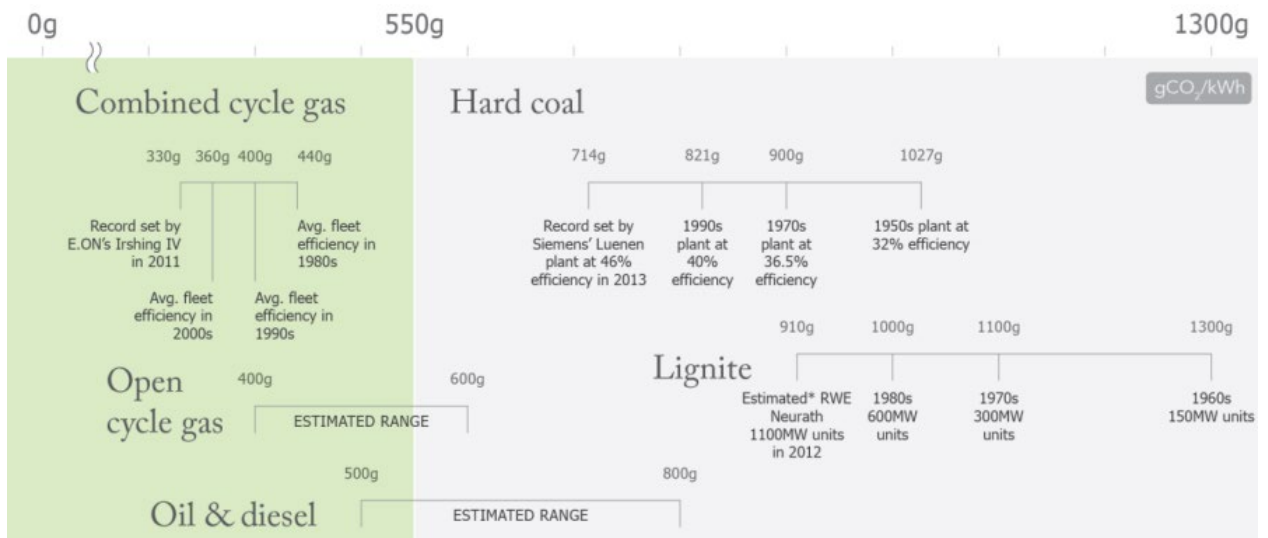

Figure 1 Assessment of carbon-intensity levels by fossil technology [1].

## References

[1] Sandbag, "Capacity payments and 550g - Why is a carbon-intensity threshold needed for Capacity Payments?," 2017.